

**John Deere  
493D  
Feller-Buncher**

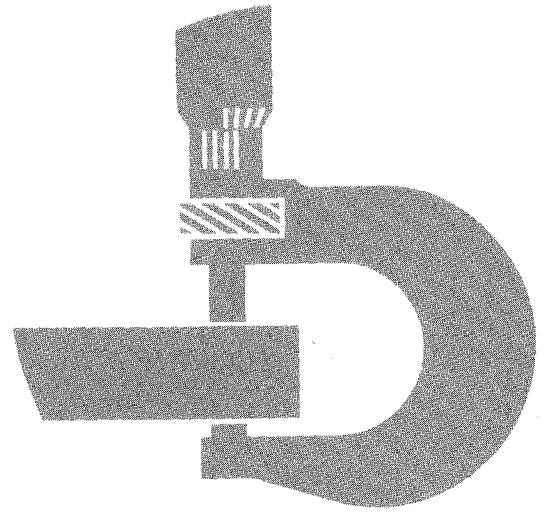

**TECHNICAL MANUAL**

**TM-1415 (Jun-88)**

LITHO IN U.S.A.

# Introduction

## FOREWORD

This manual is written for an experienced technician. Essential tools required in performing certain service work are identified in this manual and are recommended for use.

Live with safety: Read the safety messages in the introduction of this manual and the cautions presented throughout the text of the manual.



**This is the safety-alert symbol. When you see this symbol on the machine or in this manual, be alert to the potential for personal injury.**

Technical manuals are divided in two parts: repair and diagnostics. Repair sections tell how to repair the components. Diagnostic sections help you identify the majority of routine failures quickly.

Information is organized in groups for the various components requiring service instruction. At the beginning of each group are summary listings of all applicable essential tools, service equipment and tools, other materials needed to do the job, service parts kits, specifications, wear tolerances, and torque values.

Binders, binder labels, and tab sets can be ordered by John Deere dealers direct from the John Deere Distribution Service Center.

This manual is part of a total product support program.

## FOS Manuals-reference

### Technical Manuals-machine service

### Component Manuals-component service

*Fundamentals of Service (FOS) Manuals* cover basic theory of operation, fundamentals of troubleshooting, general maintenance, and basic types of failures and their causes. FOS Manuals are for training new personnel and for reference by experienced technicians.

*Technical Manuals* are concise guides for specific machines. Technical manuals are on-the-job guides containing only the vital information needed for diagnosis, analysis, testing, and repair.

*Component Technical Manuals* are concise service guides for specific components. Component technicals manuals are written as stand-alone manuals covering multiple machine applications.

## **JOHN DEERE DEALERS**

**IMPORTANT: Please remove this page and route through your service department.**

This is TM-1415, 493D Feller-Buncher.

The pages are dated (Jun-88). Listed below is a brief explanation.

This manual is to be used with:

TM-1390 490D Excavator Repair, and  
TM-1389 490D Excavator Operation and Tests

Both Feller Buncher repair and operation/test information are in this manual.

# 493D FELLER-BUNCHER TECHNICAL MANUAL TM-1415 (JUN-88)

## SECTION AND GROUP CONTENTS

*NOTE: This manual covers 493D Feller-Buncher Repair/Operation and Test, use with TM-1389 490D Excavator Operation and Test and TM-1390 490D Excavator Repair.*

### SECTION I—GENERAL INFORMATION

- Group I—Safety Information
- Group II—General Specifications
- Group III—Torque Values
- Group IV—Fuels and Lubricants
- Group V—Inspection Procedures

### SECTION 01—TRACKS

- Group 0130—Track System
  - Lower Track Roller, Track Sag

### SECTION 05—ENGINE AUXILIARY SYSTEMS

- Group 0510—Cooling System
- Group 0520—Intake System

### SECTION 16—ELECTRICAL

- Group 1674—Wiring Harness and Switches
  - Controller Switches

### SECTION 18—OPERATOR'S STATION

- Group 1800—Removal and Installation
  - FOPS, Cab
- Group 1810—Operator Enclosure
  - FOPS

### SECTION 33—EXCAVATOR

- Group 3340—Frames
  - Arm, Boom
- Group 3360—Hydraulic System
  - Main Control Valve, Forestry Package Control Valve, Reservoir, Oil Cooler Bypass Valve, Controllers and Valve, Solenoid Valves, Pressure Control Valve, Pilot Filter, Pilot Shut-Off Valve

### SECTION 9005—OPERATIONAL CHECK-OUT PROCEDURE

- Group 10—Operational Checkout Procedure

### SECTION 9015—ELECTRICAL SYSTEM

- Group 05—Theory of Operation
- Group 15—Diagnostic Information

### SECTION 9020—POWER TRAIN

- Group 20—Adjustments

### SECTION 9025—HYDRAULIC SYSTEM

- Group 05—Theory of Operation
- Group 15—Diagnostic Information
- Group 25—Tests

### **HANDLE FLUIDS SAFELY—AVOID FIRES**

When you work around fuel, do not smoke or work near heaters or other fire hazards.

Store flammable fluids away from fire hazards. Do not incinerate or puncture pressurized containers.

Make sure machine is clean of trash, grease, and debris.

Do not store oily rags; they can ignite and burn spontaneously.



AB6;TS227 053;FLAME 050188

### **PREVENT BATTERY EXPLOSIONS**

Keep sparks, lighted matches, and open flame away from the top of battery. Battery gas can explode.

Never check battery charge by placing a metal object across the posts. Use a volt-meter or hydrometer.

Do not charge a frozen battery; it may explode. Warm battery to 16°C (60°F).

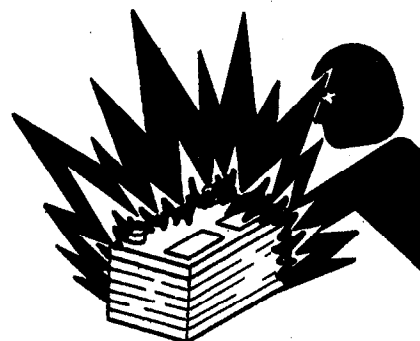

ABT;TS204 053;SPARKS 050188

### **PREPARE FOR EMERGENCIES**

Be prepared if a fire starts.

Keep a first aid kit and fire extinguisher handy.

Keep emergency numbers for doctors, ambulance service, hospital, and fire department near your telephone.

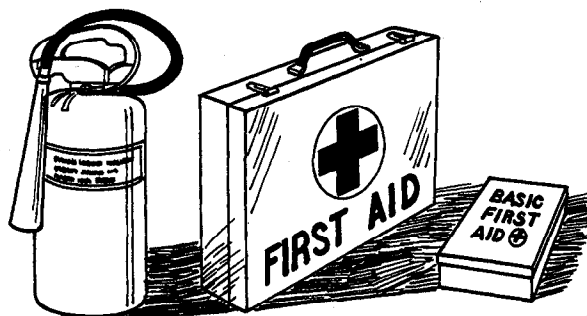

AB6;TS186 053;FIRE2 080785

## PREVENT ACID BURNS

Sulfuric acid in battery electrolyte is poisonous. It is strong enough to burn skin, eat holes in clothing, and cause blindness if splashed into eyes.

Avoid the hazard by:

1. Filling batteries in a well-ventilated area.
2. Wearing eye protection and rubber gloves.
3. Avoiding breathing fumes when electrolyte is added.
4. Avoiding spilling or dripping electrolyte.
5. Use proper jump start procedure.

If you spill acid on yourself:

1. Flush your skin with water.
2. Apply baking soda or lime to help neutralize the acid.
3. Flush your eyes with water for 10-15 minutes. Get medical attention immediately.

If acid is swallowed:

1. Drink large amounts of water or milk.
2. Then drink milk of magnesia, beaten eggs, or vegetable oil.
3. Get medical attention immediately.

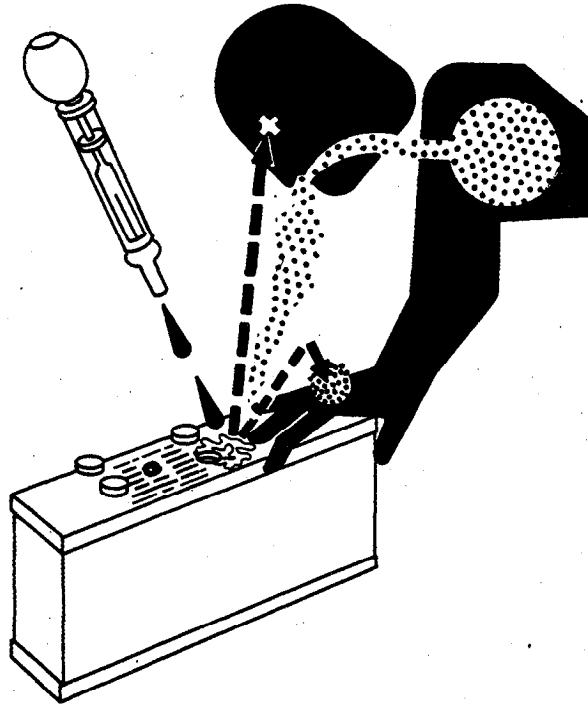

AB6;TS203 053;POISON 211287

## AVOID HIGH-PRESSURE FLUIDS

Escaping fluid under pressure can penetrate the skin causing serious injury. Relieve pressure before unhooking hydraulic or other lines. Tighten all connections before applying pressure. Keep hands and body away from pinholes and nozzles which eject fluids under high pressure. Use a piece of cardboard to search for leaks.

If ANY fluid is injected into the skin, it must be surgically removed within a few hours by a doctor familiar with this type injury or gangrene may result.

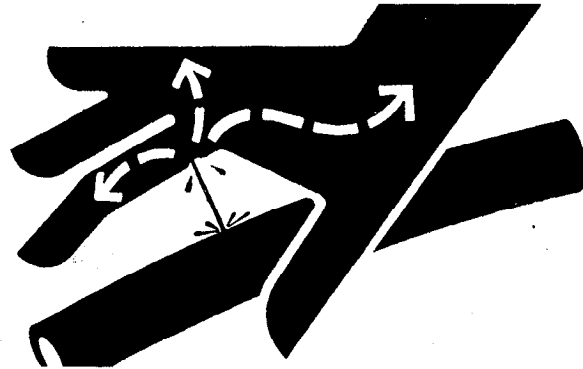

AB6;X9811 053;FLUID 180987

## PARK MACHINE SAFELY

Before working on the machine:

- Lower all equipment to the ground.
- Stop the engine and remove the key.
- Disconnect the battery ground strap.
- Hang a "DO NOT OPERATE" tag in operator station.

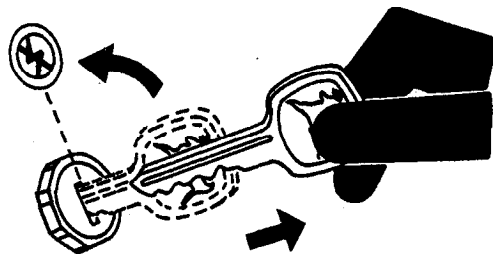

AB6;TS230 053;PARK 050188

### SUPPORT MACHINE PROPERLY

Always lower the attachment or implement to the ground before you work on the machine. If you must work on a lifted machine or attachment, securely support the machine or attachment.

Do not support the machine on cinder blocks, hollow tiles, or props that may crumble under continuous load. Do not work under a machine that is supported solely by a jack. Follow recommended procedures in this manual.

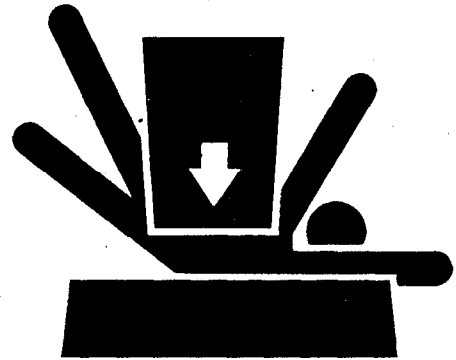

AB6;TS229 053;LOWER 211287

### WEAR PROTECTIVE CLOTHING

Wear close fitting clothing and safety equipment appropriate to the job.

Prolonged exposure to loud noise can cause impairment or loss of hearing.

Wear a suitable hearing protective device such as earmuffs or earplugs to protect against objectionable or uncomfortable loud noises.

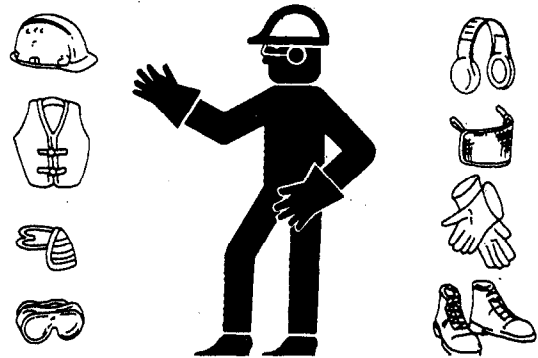

AB6;TS206 053;WEAR 230487

### SERVICE MACHINE SAFELY

Tie long hair behind your head. Do not wear a necktie, scarf, loose clothing, or necklace when you work near machine tools or moving parts. If these items were to get caught, severe injury could result.

Remove rings and other jewelry to prevent electrical shorts and entanglement in moving parts.

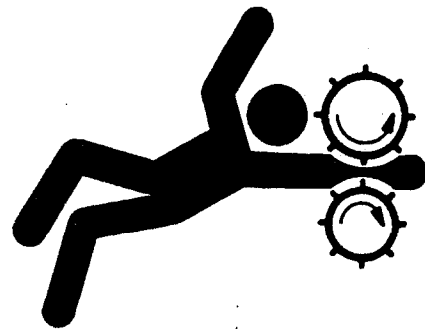

AB6;TS228 053;LOOSE 211287

### WORK IN VENTILATED AREA

Engine exhaust fumes can cause sickness or death. If it is necessary to run an engine in an enclosed area, remove the exhaust fumes from the area with an exhaust pipe extension.

If you do not have an exhaust pipe extension, open the doors and get outside air into the area.

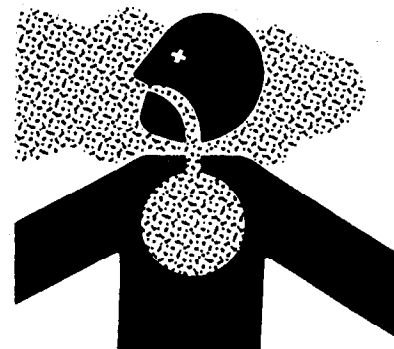

AB6;TS220 053;AIR 050188

### UNDERSTAND CORRECT SERVICE

Illuminate your work area adequately but safely. Use a portable safety light for working inside or under the machine. Make sure the bulb is enclosed by a wire cage. The hot filament of an accidentally broken bulb can ignite spilled fuel or oil.

Catch draining fuel, oil, or other fluids in suitable containers. Do not use food or beverage containers that may mislead someone into drinking from them. Wipe up spills at once.

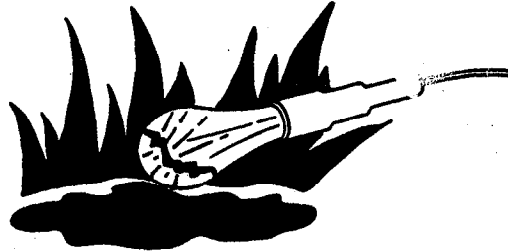

AB6;TS223 053;LIGHT 230288

### REPLACE SAFETY SIGNS

Replace missing or damaged safety signs. See the machine operator's manual for correct safety sign placement.

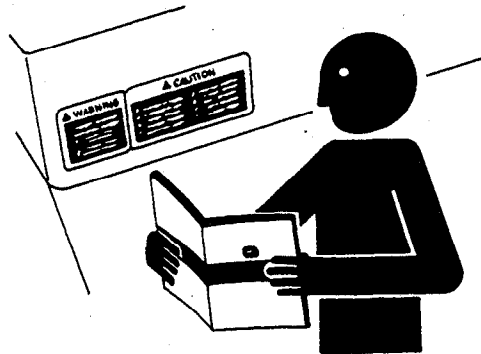

AB6;TS201 053;SIGNS1 221287

### USE PROPER LIFTING EQUIPMENT

Lifting heavy components incorrectly can cause severe injury or machine damage.

Follow recommended procedure for removal and installation of components in the manual.

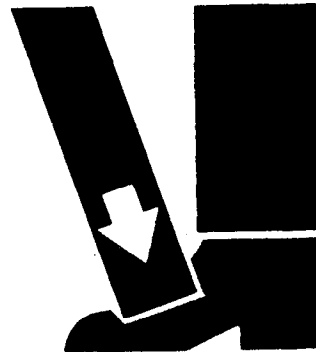

AB6;TS226 053;LIFT 050188

### KEEP ROPS INSTALLED PROPERLY

Make certain all parts are reinstalled correctly if the roll-over protective structure (ROPS) is loosened or removed for any reason. Tighten mounting bolts to proper torque.

The protection offered by ROPS will be impaired if ROPS is subjected to structural damage, is involved in an overturn incident, or is in any way altered by welding, bending, drilling, or cutting. A damaged ROPS should be replaced, not reused.

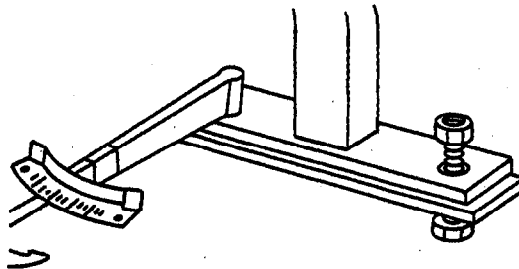

AB6;TS212 053;ROPS3 230487



## SERVICE TIRES SAFELY

Explosive separation of a tire and rim parts can cause serious injury or death.

Do not attempt to mount a tire unless you have the proper equipment and experience to perform the job.

Always maintain the correct tire pressure. Do not inflate the tires above the recommended pressure.

When inflating tires, use a clip-on chuck and extension hose long enough to allow you to stand to one side and NOT in front of or over the tire assembly. Use a safety cage if available.

Check wheels for low pressure, cuts, bubbles, damaged rims or missing lug bolts and nuts.

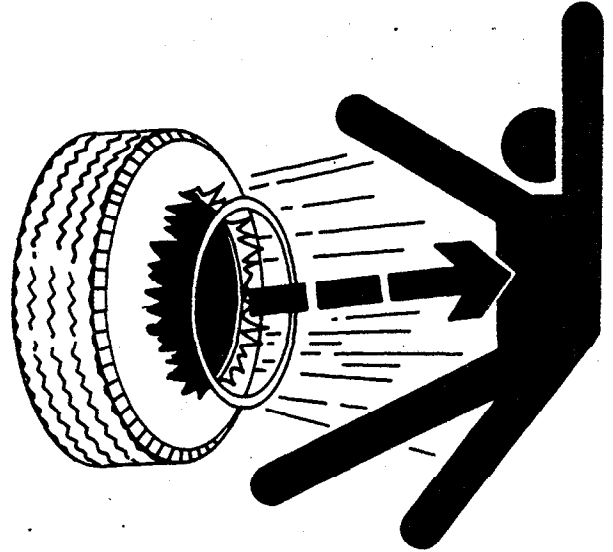

AB6;TS211 053;RIM 211287

## AVOID HARMFUL ASBESTOS DUST

Avoid breathing dust that may be generated when handling components containing asbestos fibers. Inhaled asbestos fibers may cause lung cancer.

Components in John Deere products that may contain asbestos fibers are brake pads, brake band and lining assemblies, clutch plates, and some gaskets. The asbestos used in these components is usually found in a resin or sealed in some way. Normal handling is not hazardous as long as airborne dust containing asbestos is not generated.

Avoid creating dust. Never use compressed air for cleaning. Avoid brushing or grinding of asbestos containing materials. When servicing, wear an approved respirator. A special vacuum cleaner is recommended to clean asbestos. If not available, wet the asbestos containing materials with a mist of oil or water.

Keep bystanders away from the area.

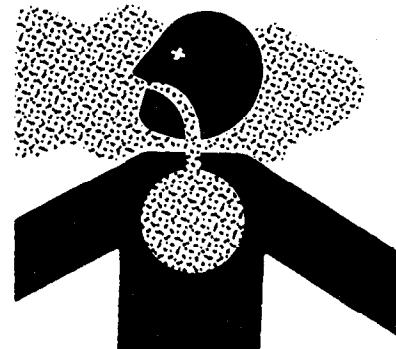

AB6;TS220 053;DUST 140488

## WORK IN CLEAN AREA

Before starting a job:

- Clean work area and machine.
- Make sure you have all necessary tools to do your job.
- Have the right parts on hand.
- Read all instructions thoroughly; do not attempt shortcuts.

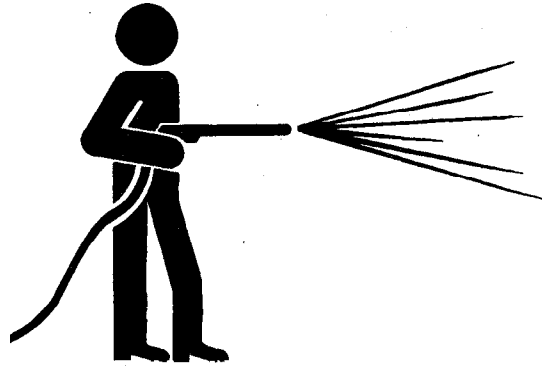

AB6;T6642E J 053;CLEAN 190188

## USE TOOLS PROPERLY

Use tools appropriate to the work. Makeshift tools, parts, and procedures will not make good repairs.

Use pneumatic and electric tools only to loosen threaded parts and fasteners. Never use such tools to tighten fasteners, especially on light alloy parts.

Use only replacement parts meeting John Deere specifications.

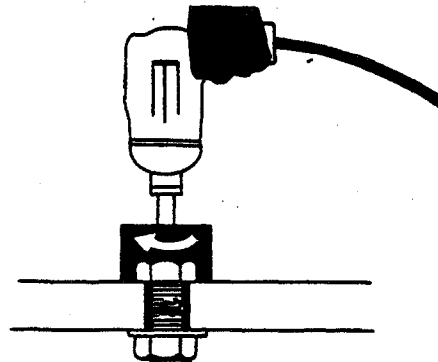

AB6;TS221 053;REPAIR 211287

## DISPOSE FLUIDS PROPERLY

Be mindful of the environment and ecology. Before you drain fluids, find out the proper way to dispose of the oil.

Do not pour oil onto the ground, down a drain, or into a stream, pond, or lake. Consult local ordinances that govern the disposal of wastes.

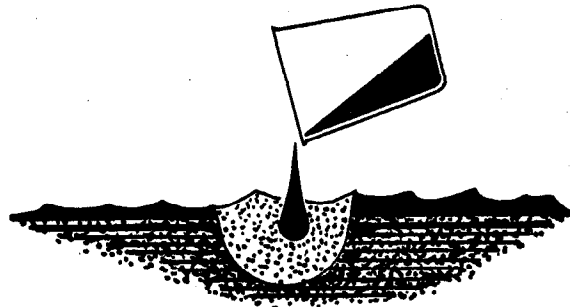

AB6;TS222 053;DRAIN 211287

## LIVE WITH SAFETY

Before returning machine to customer, make sure machine is functioning properly, especially the safety systems. Install all guards and shields.



AB6;TS231 053;LIVE 050188

**493D FELLER-BUNCHER DIMENSIONS**

493D Feller-Buncher equipped with a Timbco 21-in. (53 cm) Saw

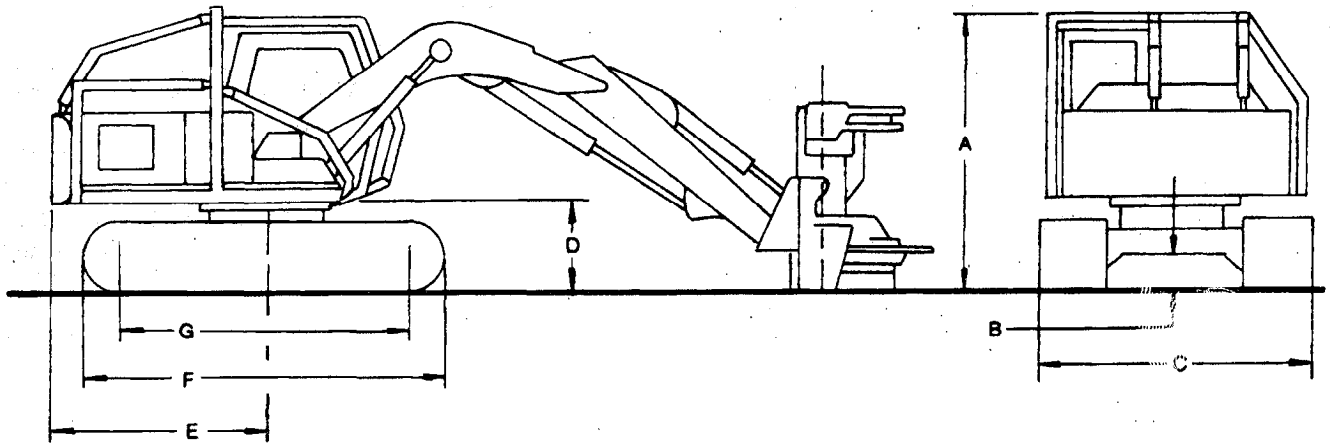

A—Overall height .....	2.9 m (9 ft 6 in.)
B—Minimum ground clearance .....	440 mm (1 ft 5 in.)
C—Overall width	
With 500 mm (20 in.) shoes .....	2.5 m (8 ft 2 in.)
With 600 mm (24 in.) shoes .....	2.6 m (8 ft 6 in.)
With 700 mm (28 in.) shoes .....	2.7 m (8 ft 10 in.)
D—Counterweight clearance .....	900 mm (2 ft 11 in.)
E—Rear end length .....	2.2 m (7 ft 3 in.)
Rear end swing radius .....	2.2 m (7 ft 3 in.)
F—Overall track length .....	3.5 mm (11 ft 6 in.)
G—Distance between tumblers .....	2.8 m (9 ft 1 in.)
H—Shipping weight .....	13 846 kg (30,525 lb)

044;T6737FC 05T;115 K67 040588

## General Specifications

*(Specifications and design subject to change without notice. Wherever applicable, specifications are in accordance with SAE standards. Except where otherwise noted, these specifications are based on a unit with 600 mm (24 in.) track shoes, full fuel tank, 79 kg (175 lb) operator, and standard equipment.*

Engine: John Deere 4-276T

Type .....	4-stroke cycle, turbocharged diesel
Bore and stroke .....	106.4 x 127 mm (4.19 x 5 in.)
No. of cylinders .....	4
Displacement .....	4.5 L (276 cu in.)
Compression ratio .....	16.8:1
Maximum net torque at 1300 rpm .....	339 N·m (34.6 kg/m) (250 lb-ft)
Lubrication .....	Pressure system with full-flow filter
Cooling fan .....	Suction type viscous drive
Air cleaner .....	Dry
Electrical system .....	24-volt with 42 amp alternator
Batteries (2) 12 volt .....	Reserve capacity: 180 minutes

Power at 2000 engine rpm .....	SAE
Net .....	93 Kw (125 hp)

05T;115 K68 200588

## DRAIN AND REFILL CAPACITIES

Fuel tank .....	250 L	66 gal
Cooling system .....	18 L	19 qt
Engine lubrication, including filter .....	13 L	14 qt
Hydraulic reservoir .....	72 L	1.9 gal
Swing gear .....	9 kg	20 lb
Propel drive (each) .....	3.5 L	3.8 qt

05T;115 K69. 200588

# Group III Torque Values

## Bolt Tightening Torque

Bolts are classified into three kinds according to their materials.



T-BOLT



H-BOLT



M-BOLT

Unit: Nm (lb-ft)

Nominal dia(mm) Kind	8	10	12	14	16	18	20	22	24	27	30	33	36
T-BOLT	29 (21)	63 (46)	108 (80)	176 (130)	265 (195)	392 (289)	539 (398)	735 (542)	931 (687)	1372 (1012)	1911 (1410)	2548 (1880)	3136 (2314)
H-BOLT	20 (15)	45 (33)	88 (65)	137 (101)	206 (152)	294 (217)	392 (289)	539 (398)	686 (506)	1029 (759)	1421 (1048)	1911 (1410)	2401 (1772)
M-BOLT	10 (7)	20 (15)	34 (25)	54 (40)	78 (58)	118 (87)	167 (123)	216 (159)	274 (202)	392 (289)	539 (398)	735 (542)	931 (687)

(Tolerance: ±10%)

## Flared Type Joint Tightening Torque

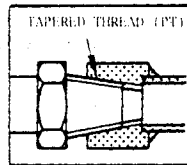

TAPERED THREAD

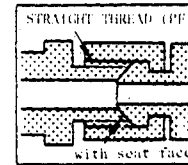

STRAIGHT THREAD  
(with seat face)

Unit: Nm (lb-ft)

KIND OF THREAD THREAD (inch)	1/8	1/4	3/8	1/2	3/4	1	1-1/4	1-1/2	2
TAPERED THREAD	15 (11)	20 (15)	29 (21)	49 (36)	69 (51)	108 (80)	157 (116)	196 (145)	255 (188)
STRAIGHT THREAD	—	45 (33)	69 (51)	93 (69)	176 (130)	206 (152)	343 (253)	539 (398)	588 (434)

(Tolerance: ±10%)

Note: If female thread is of cast iron (in case of control valves, brake valve motors etc.), the torque must be reduced by about 10%.

Torque Values

**INCH SERIES TORQUE CHART**

Check tightness of cap screws periodically.









Torque values listed are for general use only. Do not use these values if a different torque value or tightening procedure is listed for a specific application.

Shear bolts are designed to fail under predetermined loads. Always replace shear bolts with identical grade.

Fasteners should be replaced with the same or higher grade. If higher grade fasteners are used, these should only be tightened to the strength of the original.

Make sure fastener threads are clean and you properly start thread engagement. This will prevent them from failing when tightening.

Tighten cap screws having lock nuts to approximately 50 percent of amount shown in chart.

SAE Grade	Head Markings	SAE Grade	Nut Markings
SAE GRADE 1 SAE GRADE 2	 No Mark	2	 No Mark
SAE GRADE 5 SAE GRADE 5.1 SAE GRADE 5.2	  	5	
SAE GRADE 8 SAE GRADE 8.2	 	8	

DIA.	WRENCH SIZE	SAE GRADE 1		SAE GRADE 2		SAE GRADE 5		SAE GRADE 8	
		OIL	DRY	OIL	DRY	OIL	DRY	OIL	DRY
		N·m(lb-in)	N·m(lb-in)	N·m(lb-in)	N·m(lb-in)	N·m(lb-in)	N·m(lb-in)	N·m(lb-in)	N·m(lb-in)
#6		0.5(4.5)	0.7(6)	0.8(7)	1(10)	1.4(12)	1.7(15)		
#8		0.9(8)	1.2(11)	1.5(13)	2(18)	2.4(21)	3.2(28)		
#10		1.4(12)	1.8(16)	2(19)	2.8(25)	3.4(30)	4.6(41)		
#12		2(19)	2.8(25)	3.4(30)	4.5(40)	5.4(48)	7.3(65)		
		N·m(lb-ft)	N·m(lb-ft)	N·m(lb-ft)	N·m(lb-ft)	N·m(lb-ft)	N·m(lb-ft)	N·m(lb-ft)	N·m(lb-ft)
1/4	7/16	3.5(2.5)	4(3.0)	5(4.0)	7(5.0)	8(6.0)	11(8.0)	12(8.5)	16(12)
5/16	1/2	7(5.0)	9(6.5)	10(7.5)	14(10.0)	16(12.0)	23(17.0)	24(18.0)	33(24)
3/8	9/16	12(8.5)	16(12.0)	19(14.0)	24(18.0)	30(22.0)	41(30)	41(30)	54(40)
7/16	5/8	19(14.0)	26(19.0)	30(22.0)	41(30)	47(35)	68(50)	68(50)	95(70)
1/2	3/4	24(21.0)	41(30)	47(35)	61(45)	75(55)	102(75)	102(75)	142(105)
9/16	13/16	41(30)	54(40)	68(50)	88(65)	108(80)	142(105)	149(110)	203(150)
5/8	15/16	54(40)	75(55)	88(65)	122(90)	149(110)	197(145)	203(150)	278(205)
3/4	1-1/8	102(75)	136(100)	163(120)	217(160)	258(190)	353(260)	366(270)	495(365)
7/8	1-5/16	163(120)	224(165)	163(120)	224(165)	414(305)	563(415)	590(435)	800(590)
1	1-1/2	244(180)	332(245)	244(180)	332(245)	624(460)	848(625)	881(650)	1193(880)
1-1/8	1-11/16	346(255)	468(345)	346(255)	468(345)	780(575)	1058(780)	1248(920)	1695(1250)
1-1/4	1-7/8	488(360)	664(490)	488(360)	665(490)	1098(810)	1492(1100)	1763(1300)	2393(1765)
1-3/8	2-1/16	637(470)	868(640)	637(470)	868(640)	1438(1061)	1953(1440)	2312(1705)	3140(2315)
1-1/2	2-1/4	848(625)	1153(850)	848(625)	1153(850)	1912(1410)	2590(1910)	3065(2260)	4163(3070)

AB6;TS236, TS237 053;TORQ3. 220188

### METRIC SERIES TORQUE CHART

**⚠ CAUTION: Use only metric tools on metric hardware. Other tools may not fit properly. They may slip and cause injury.**

















Check tightness of cap screws periodically. Torque values listed are for general use only. Do not use these values if a different torque value or tightening procedure is listed for a specific application.

Shear bolts are designed to fail under predetermined loads. Always replace shear bolts with identical grade.

Fasteners should be replaced with the same or higher grade. If higher grade fasteners are used, these should only be tightened to the strength of the original.

Make sure fastener threads are clean and you properly start thread engagement. This will prevent them from failing when tightening.

Tighten cap screws having lock nuts to approximately 50 percent of amount shown in chart.

Property Class	Head Markings	Property Class	Nut Markings
4.6	  No Mark	5	  No Mark
4.8	  No Mark		
8.8		8	 
9.8		10	 
10.9			
12.9		12	 

DIA.	WRENCH SIZE	4.6		4.8		8.8		9.8		10.9		12.9	
		OIL	DRY	OIL	DRY	OIL	DRY	OIL	DRY	OIL	DRY	OIL	DRY
		N·m(lb-ft)	N·m(lb-ft)	N·m(lb-ft)	N·m(lb-ft)	N·m(lb-ft)	N·m(lb-ft)	N·m(lb-in)	N·m(lb-in)	N·m(lb-ft)	N·m(lb-ft)	N·m(lb-ft)	N·m(lb-ft)
M5	8mm	1.5(1)	2.5(1.5)	2.5(1.5)	3.0(2)	4.5(3.5)	6.0(4.5)	5.0(3.5)	7.0(5)	6.5(4.5)	9.0(6.5)	7.5(5.5)	10.0(7.5)
M6	10mm	3.0(2)	4.0(3)	4.0(3)	5.5(4)	7.5(5.5)	10.0(7.5)	8.5(6)	12.0(9)	11.0(8)	15.0(11)	13.0(9.5)	18.0(13)
M8	13mm	7.0(5)	9.5(7)	10.0(7.5)	13.0(10)	18.0(13)	25(18)	21.0(15)	30(22)	25(18)	35(26)	30(22)	45(33)
M10	16mm	14.0(10)	19.0(14)	20.0(15)	25(18)	35(26)	50(37)	40(30)	55(41)	55(41)	75(55)	65(48)	85(63)
M12	18mm	25(18)	35(26)	35(26)	45(33)	65(48)	85(63)	70(52)	100(74)	95(70)	130(97)	110(81)	150(111)
M14	21mm	40(30)	50(37)	55(41)	75(55)	100(74)	140(103)	115(85)	155(114)	150(111)	205(151)	175(129)	240(177)
M16	24mm	60(44)	80(59)	85(63)	115(85)	160(118)	215(159)	180(133)	245(180)	235(173)	315(232)	275(203)	370(273)
M18	27mm	80(59)	110(81)	115(85)	160(118)	225(166)	305(225)			320(236)	435(321)	375(277)	510(376)
M20	30mm	115(85)	160(118)	165(122)	225(166)	320(236)	435(321)			455(356)	620(457)	535(395)	725(535)
M22	33mm	160(118)	215(159)	225(167)	305(225)	435(321)	590(435)			620(457)	840(620)	725(535)	985(726)
M24	36mm	200(148)	275(203)	285(210)	390(288)	555(409)	750(553)			790(583)	1070(789)	925(682)	1255(926)
M27	41mm	295(218)	400(295)	415(306)	565(417)	810(597)	1100(811)			1155(852)	1565(1154)	1350(996)	1835(1353)
M30	46mm	400(295)	545(402)	565(417)	770(568)	1100(811)	1495(1103)			1570(1158)	2130(1571)	1835(1353)	2490(1837)
M33	51mm	545(402)	740(546)	770(568)	1050(774)	1500(1106)	2035(1500)			2135(1575)	2900(2139)	2500(1844)	3390(2500)
M36	55mm	700(516)	950(700)	990(730)	1345(992)	1925(1420)	2610(1925)			2740(2021)	3720(2744)	3205(2364)	4355(3212)

## SERVICE RECOMMENDATIONS FOR O-RING BOSS FITTINGS

### Straight Fitting

1. Inspect O-ring boss seat for dirt or defects.
2. Lubricate O-ring with petroleum jelly. Place electrical tape over threads to protect O-ring. Slide O-ring over tape and into O-ring groove of fitting. Remove tape.
3. Tighten fitting to torque value shown on chart.

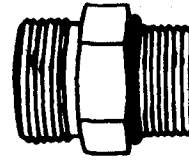

### Angle Fitting

1. Back-off lock nut (A) and back-up washer (B) completely to head-end (C) of fitting.
2. Turn fitting into threaded boss until back-up washer (B) contacts face of boss.
3. Turn fitting head-end (C) counterclockwise to proper index (maximum of one turn).
4. Hold fitting head-end (C) with a wrench and tighten locknut (A) and back-up washer (B) to proper torque value.

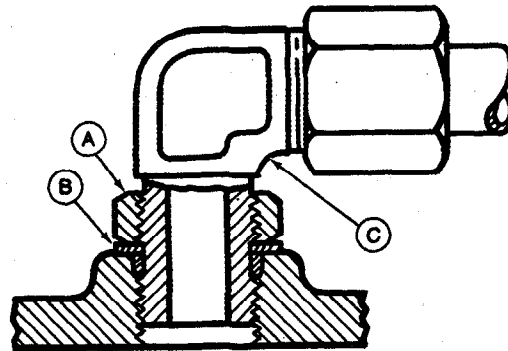

*NOTE: Do not allow hoses to twist when tightening fittings.*

### TORQUE VALUE CHART

Thread Size	Torque	
	N-m	(lb-ft)
3/8-24 UNF	8	(6)
7/16-20 UNF	12	(9)
1/2-20 UNF	16	(12)
9/16-18 UNF	24	(18)
3/4-16 UNF	46	(34)
7/8-14 UNF	62	(46)
1-1/16-12 UN	102	(75)
1-3/16-12 UN	122	(90)
1-5/16-12 UN	142	(105)
1-5/8-12 UN	190	(140)
1-7/8-12 UN	217	(160)

*NOTE: Torque tolerance is  $\pm 10\%$ .*



**SERVICE RECOMMENDATIONS FOR FLAT FACE O-RING SEAL FITTINGS**

1. Inspect the fitting sealing surfaces. They must be free of dirt or defects.
2. Inspect the O-ring. It must be free of damage or defects.
3. Lubricate O-rings and install into groove using petroleum jelly to hold in place.
4. Push O-ring into the groove with plenty of petroleum jelly so O-ring is not displaced during assembly.
5. Index angle fittings and tighten by hand pressing joint together to insure O-ring remains in place.
6. Tighten fitting or nut to torque value shown on the chart per dash size stamped on the fitting. Do not allow hoses to twist when tightening fittings.

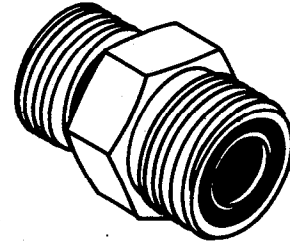

**FLAT FACE O-RING SEAL FITTING TORQUE**

Nominal		Dash Size	Thread Size in.	Swivel Nut Torque		Bulkhead Nut Torque	
Tube mm	O.D. (in.)			Nm	(lb-ft)	Nm	(lb-ft)
6.35	0.250	-4	9/16-18	16	12	5.0	3.5
9.52	0.375	-6	11/16-16	24	18	9.0	6.5
12.70	0.500	-8	13/16-16	50	37	17.0	12.5
15.88	0.625	-10	1-14	69	51	17.0	12.5
19.05	0.750	-12	1 3/16-12	102	75	17.0	12.5
22.22	0.875	-14	1 3/16-12	102	75	17.0	12.5
25.40	1.000	-16	1 7/16-12	142	105	17.0	12.5
31.75	1.250	-20	1 11/16-12	190	140	17.0	12.5
38.10	1.500	-24	2-12	217	160	17.0	12.5

*NOTE: Torque tolerance is +15 -20%.*



**Suggest:**

**If the above button click is invalid.**

**Please download this document**

**first, and then click the above link**

**to download the complete manual.**

**Thank you so much for reading**

### SAE FOUR BOLT FLANGE FITTING SERVICE RECOMMENDATIONS

1. Inspect the sealing surfaces for nicks or scratches, roughness or out-of-flat condition. Scratches cause leaks. Roughness causes seal wear. Out-of-flat causes seal extrusion. If these defects cannot be polished out, replace the component.

2. Install the correct O-ring (and backup washer if required) into the groove using petroleum jelly to hold it in place.

3. For split flange; loosely assemble split flange halves, being sure that the split is centrally located and perpendicular to the port. Hand tighten cap screws to hold parts in place. Do not pinch O-ring.

4. For single piece flange; put hydraulic line in the center of the flange and install four cap screws. With the flange centrally located on the port, hand tighten cap screws to hold it in place. Do not pinch O-ring.

5. For both single piece flange and split flange, be sure the components are properly positioned and cap screws are hand tight. Tighten one cap screw, then tighten the diagonally opposite cap screw. Tighten the two remaining cap screws. Tighten all cap screws within the specified limits shown in the chart.

DO NOT use air wrenches. DO NOT tighten one cap screw fully before tightening the others. DO NOT overtighten.

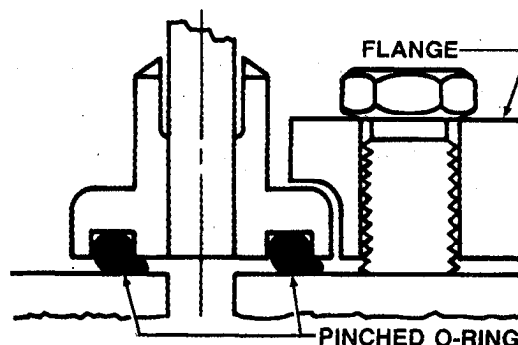
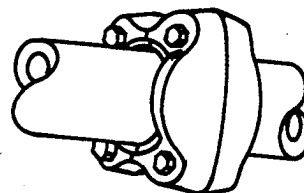

### SAE FOUR BOLT FLANGE FITTING TORQUE

Nominal Flange Size	Cap Screw Size <sup>1</sup>	Torque <sup>2</sup>			
		N·m		(lb-ft)	
		Min.	Max.	Min.	Max.
1/2	5/16 - 18 UNC	20	31	(15)	(23)
3/4	3/8 - 16 UNC	28	54	(21)	(40)
1	M10 10.9	58	88	(43)	(65)
	3/8 - 16 UNC	37	54	(27)	(40)
1-1/4	M12 10.9	104	156	(77)	(115)
	7/16 - 14 UNC	47	85	(35)	(63)
1-1/2	1/2 - 13 UNC	62	131	(46)	(97)
2	1/2 - 13 UNC	73	131	(54)	(97)
2-1/2	1/2 - 13 UNC	107	131	(79)	(97)
3	5/8 - 11 UNC	158	264	(117)	(195)
3-1/2	5/8 - 11 UNC	158	264	(117)	(195)
4	5/8 - 11 UNC	158	264	(117)	(195)
5	5/8 - 11 UNC	158	264	(117)	(195)

1. SAE Grade 5 or better cap screws with plated hardware.

2. Tolerance  $\pm 10\%$ . The torques given are enough for the given size connection with the recommended working pressure. Torques can be increased to the maximum shown for each cap screw size if desired. Increasing cap screw torque beyond this maximum will result in flange and cap screw bending and connection failures.

018;T6575AG, T6561AG 04T;90 K68. 251187