

**JOHN DEERE**  
**WORLDWIDE COMMERCIAL & CONSUMER**  
**EQUIPMENT DIVISION**

---

**Sabre Garden Tractors**  
**2048HV, 2254HV, and 2554HV**

---

**OPERATOR'S MANUAL**



**OMM140479 I9**

North American Version  
Litho in U.S.A.

# INTRODUCTION

---

## Thank You for Purchasing a John Deere Product

We appreciate your business and wish you many years of safe and satisfied use of your machine.

## Using Your Operator's Manual

This manual is an important part of your machine and should remain with the machine when you sell it.

Reading your operator's manual will help you and others avoid personal injury or damage to the machine. Information given in this manual will provide the operator with the safest and most effective use of the machine. Knowing how to operate this machine safely and correctly will allow you to train others who may operate this machine.

Section in your operator's manual are placed in a specific order to help you understand all the safety messages and learn the controls so you can operate this machine safely. You can also use this manual to answer any specific operating or servicing questions. A convenient index located at the end of this book will help you to find needed information quickly.

The machine shown in this manual may differ slightly from your machine, but will be similar enough to help you understand our instructions.

RIGHT-HAND and LEFT-HAND sides are determined by facing in the direction the machine will travel when going forward. When you see a broken line arrow (----->), the item referred to is hidden from view.

## Special Messages

Your manual contains special messages to bring attention to potential safety concerns, machine damage as well as helpful operating and servicing information. Please read all the highlighted information carefully to avoid injury and machine damage.

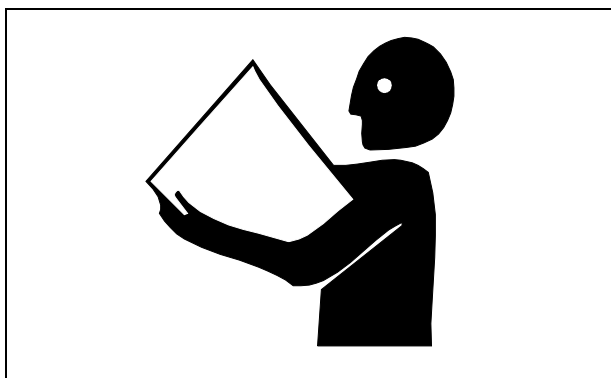

**CAUTION: Avoid injury!**

This symbol and text highlight potential hazards or death to the operator or bystanders may occur if the hazards or procedures are ignored.

**IMPORTANT: Avoid machine damage! This text is used to tell the operator of actions or conditions that might result in damage to the machine.**

**NOTE: General information is given throughout the manual that may help the operator in the operation of the machine.**

## CALIFORNIA Proposition 65 Warning



**WARNING:** The Engine Exhaust from this product contains chemicals known to the State of California to cause cancer, birth defects or other reproductive harm.

# PRODUCT IDENTIFICATION

---

## Record Identification Numbers

### Sabre Garden Tractors

2048HV, 2254HV & 2554HV PIN No. (020001 - )

If you need to contact an Authorized Service Center for information on servicing, always provide the product model and serial number.

You will need to locate the identification number for the machine and for the engine. Record the information in the spaces provided below.

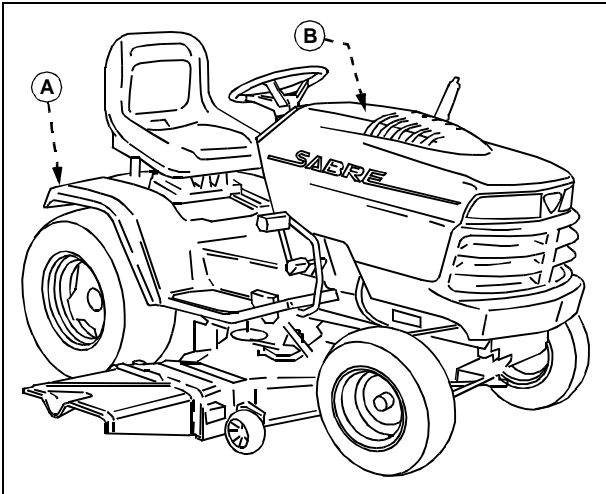

DATE OF PURCHASE:

\_\_\_\_\_

DEALER NAME:

\_\_\_\_\_

DEALER PHONE:

\_\_\_\_\_

PRODUCT IDENTIFICATION NUMBER (A):

-----

ENGINE SERIAL NUMBER (B):

-----

---

---

# TABLE OF CONTENTS

---

---

## Contents

Safety Signs .....	1
Operating .....	7
Replacement Parts .....	19
Service Interval Chart .....	21
Service Lubrication .....	23
Service Engine .....	24
Service Transmission .....	28
Service Mower .....	29
Service Electrical .....	33
Service Miscellaneous .....	37
Troubleshooting .....	41
Storing Machine .....	45
Assembly .....	47
Specifications .....	52
Warranty .....	55
Index .....	58
Sabre by John Deere Quality Statement .....	63
Service Record .....	64

All information, illustrations and specifications in this manual are based on the latest information at the time of publication. The right is reserved to make changes at any time without notice.

COPYRIGHT© 1999  
Deere & Co.  
John Deere Worldwide Commercial and  
Consumer Equipment Division  
Horicon, WI  
All rights reserved  
Previous Editions  
COPYRIGHT© 1998 and 1997

English

# SAFETY

## Understanding The Machine Safety Labels

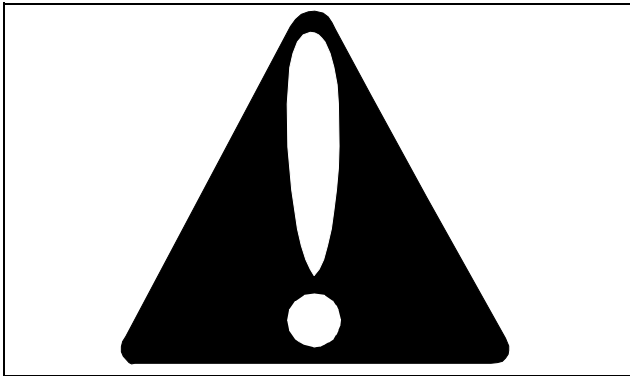

The machine safety labels shown in this section are placed in important areas on your machine to draw attention to potential safety hazards.

On your machine safety labels, the words DANGER, WARNING, and CAUTION are used with this safety-alert symbol, (▲). DANGER identifies the most serious hazards.

The operator's manual also explains any potential safety hazards whenever necessary in special safety messages that are identified with the word, CAUTION, and the safety-alert symbol, (▲).

## DANGER: ROTATING BLADES CUT OFF ARMS AND LEGS



- Do not mow when children or others are around
- Do not mow in reverse
- Look down and behind before and while backing
- Never carry children

## WARNING: AVOID SERIOUS INJURY OR DEATH

- Drive up and down slopes, not across
- Avoid sudden turns
- If machine stops going uphill, stop blade and back down slowly
- Keep safety devices (guards, shields, and switches) in place and working
- Read operator's manual
- When leaving machine:
  - Stop engine
  - Set park brake
  - Remove key

## WARNING: LOADED SPRING

Lock lift lever forward before changing attachments.



Picture Note: One decal on each side of tractor frame

# SAFETY

## DANGER/POISON

Shield eyes.



**Picture Note: Located on Battery**

Explosive gases can cause blindness or injury.

NO

- Sparks
- Flames
- Smoking

Sulfuric acid can cause blindness or severe burns

Flush eyes immediately with water.

Get medical help fast.

Maintenance-free

Keep out of the reach of children. Do not tip. Do not open battery!

## DANGER: ROTATING BLADE



Do not put hands or feet under or into mower when engine is running.

## THROWN OBJECTS

Before mowing, clear area of objects that may be thrown by blade.

Do not operate mower without discharge chute or entire grass catcher in place.

## DANGER

### ROTATING BLADE



**Picture Note: Located on Left-Hand side of deck**

Do not put hands or feet under or into mower when engine is running.

## Certification Label

This OPEI label on your mower indicates that this model has been certified by an independent laboratory for compliance with American National Standard B-71.1-1996, "Safety Specifications" for Power Lawn Mowers, Lawn and Garden Tractors, and Lawn Tractors.

# SAFETY

## Operate Safely

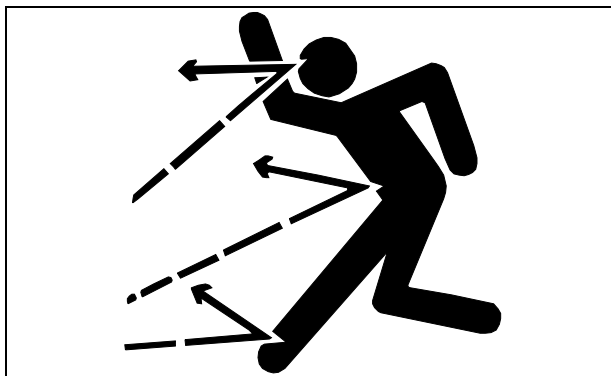

- In addition to reading your Operator's Manual, view your John Deere Mowing Safety Video.
- Check brake action before you operate. Adjust or service brakes as necessary.
- Inspect machine before you operate. Be sure hardware is tight. Repair or replace damaged, badly worn, or missing parts. Be sure guards and shields are in good condition and fastened in place. Make any necessary adjustments before you operate.
- Clear work area of objects that might be thrown. Keep people and pets out of the work area. Stop machine if anyone enters the area.
- If you hit an object, stop the machine and inspect it. Make repairs before you operate. Keep machine and attachments properly maintained and in good working order.
- DO NOT leave machine unattended when it is running.
- Only operate during daylight or with good artificial light.
- Be careful of traffic when operating near or crossing roadways.
- Do not wear radio or music headphones while operating the machine. Safe operation requires your full attention.
- Older adults are involved in a large percentage of riding mower accidents involving injury. These operators should evaluate their ability to operate a mower safely enough to protect the operator and others from serious injury.

## Park Safely

- Stop machine on a level surface, not on a slope.
- Disengage mower blades.
- Lower attachments to the ground.
- Engage park brake.
- STOP engine.
- Remove key.

- Before you leave the operator's seat, wait for engine and all moving parts to STOP.

## Rotating Blades are Dangerous - Protect Children and Prevent Accidents

PROTECT CHILDREN:

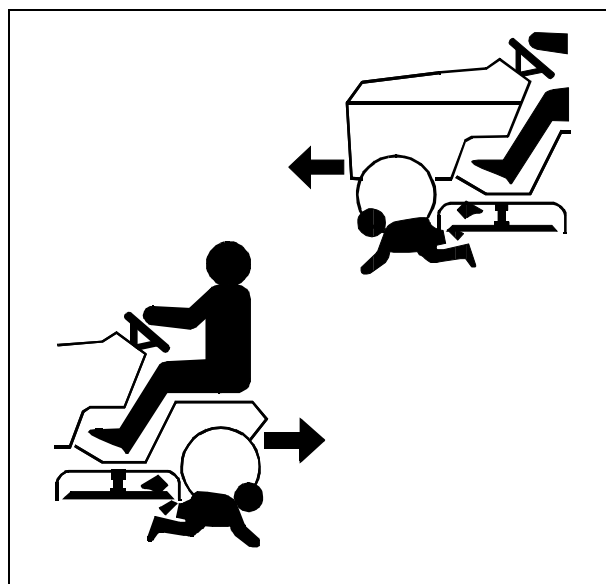

- Never assume that children will remain where you last saw them. Children are attracted to mowing activity, stay alert to the presence of children.
- Keep children in the house when you are operating the machine.
- Turn machine off if a child enters the mowing area.
- Use extra care when you come to blind corners, shrubs, trees, or other objects that may block your vision.
- DO NOT let children or an untrained person operate the machine.
- DO NOT carry or let children ride on machine or any attachment. DO NOT tow children in a cart or trailer.

HELP PREVENT SERIOUS OR FATAL ACCIDENTS:

- Be alert at all times, drive forward carefully. People especially children can move quickly into the mowing area before you know it.
- Back carefully. Disengage mower blades and look behind the machine carefully, especially for children, before you back up.
- DO NOT mow in reverse unless it is absolutely necessary.
- Disengage mower blades when you are not mowing.
- DO NOT operate machine if you are under the influence

---

# SAFETY

---

of drugs or alcohol.

## Avoid Tipping

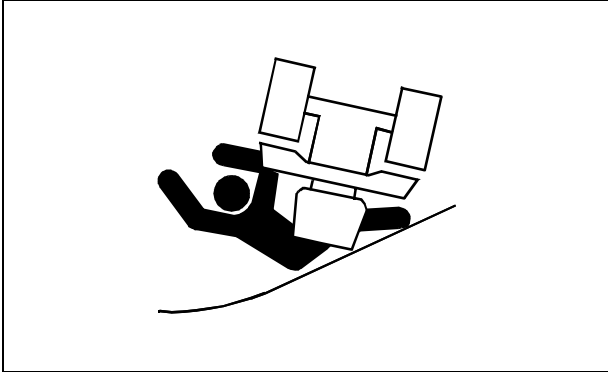

- DO NOT drive where machine could slip or tip.
- Stay alert for holes and other hidden hazards in the terrain.
- Keep away from drop-offs.
- Slow down before you make a sharp turn or operate on a slope.
- When pulling loads or using heavy equipment, use only approved hitches, limit loads to those you can safely control, and use counterweights or wheel weights when required per this manual or your attachment manual.
- Drive up and down a hill—not across. Be careful when you change direction on a slope.
- DO NOT stop when going up hill or down hill. If machine stops going up hill, DISENGAGE mower blades and back down slowly.
- DO NOT mow wet grass. Reduced traction could cause sliding.
- DO NOT try to stabilize the machine by putting your foot on the ground.

## Keep Riders Off



- Only allow the operator on the machine. Keep riders off.
- Riders on the machine or attachment may be struck by foreign objects or thrown off the machine causing serious injury.
- Riders obstruct the operator's view resulting in the machine being operated in an unsafe manner.

## Stay Clear of Rotating Drivelines

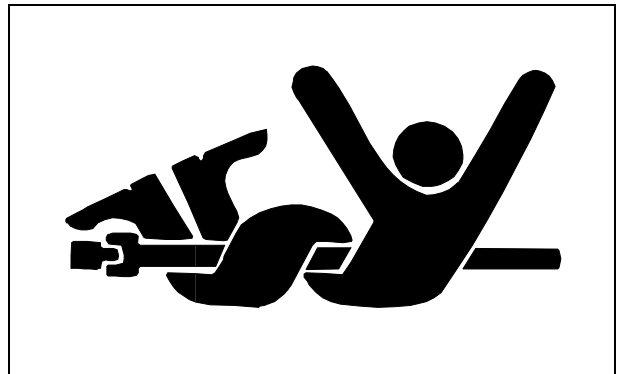

Entanglement in rotating driveline can cause serious injury or death:

- Wear close fitting clothing.
- STOP the engine and be sure PTO driveline is stopped before getting near it.



Thank you so much for reading.  
Please click the “Buy Now!”  
button below to download the  
complete manual.



After you pay.

You can download the most  
perfect and complete manual in  
the world immediately.

Our support email:

[ebooklibonline@outlook.com](mailto:ebooklibonline@outlook.com)