

**JOHN DEERE**  
**WORLDWIDE COMMERCIAL & CONSUMER**  
**EQUIPMENT DIVISION**

---

**Lawn Tractors**  
**LT 170, LT 180**

**OMM147259 J1**

**OPERATOR'S MANUAL**



**JOHN DEERE**

**⚠ WARNING:** The Engine Exhaust from this product contains chemicals known to the State of California to cause cancer, birth defects or other reproductive harm.

California Proposition 65 Warning

North American Version  
Litho in U.S.A.

# INTRODUCTION

---

## Thank You for Purchasing a John Deere Product

We appreciate having you as a customer and wish you many years of safe and satisfied use of your machine.

## Using Your Operator's Manual

This manual is an important part of your machine and should remain with the machine when you sell it.

Reading your operator's manual will help you and others avoid personal injury or damage to the machine. Information given in this manual will provide the operator with the safest and most effective use of the machine. Knowing how to operate this machine safely and correctly will allow you to train others who may operate this machine.

This manual and safety signs on your machine may also be available in other languages (see your John Deere dealer to order).

Sections in your operator's manual are placed in a specific order to help you understand all the safety messages and learn the controls so you can operate this machine safely. You can also use this manual to answer any specific operating or servicing questions. A convenient index located at the end of this book will help you to find needed information quickly.

The machine shown in this manual may differ slightly from your machine, but will be similar enough to help you understand our instructions.

RIGHT-HAND and LEFT-HAND sides are determined by facing in the direction the machine will travel when going forward. When you see a broken line arrow (----->), the item referred to is hidden from view.

Before delivering this machine, your dealer performed a predelivery inspection to ensure best performance.

## Special Messages

Your manual contains special messages to bring attention to potential safety concerns, machine damage as well as helpful operating and servicing information. Please read all the information carefully to avoid injury and machine damage.

**IMPORTANT: Avoid damage! This text is used to tell the operator of actions or conditions that might result in damage to the machine.**

**NOTE: General information is given throughout the manual that may help the operator in the operation or service of the machine.**



**CAUTION: Avoid injury! This symbol and text highlight potential hazards or death to the operator or bystanders that may occur if the hazards or procedures are ignored.**

# PRODUCT IDENTIFICATION

## Record Identification Numbers

### Lawn Tractor

LT170, LT180 PIN (10001-)

If you need to contact an Authorized Service Center for information on servicing, always provide the product model and identification numbers.

You will need to locate the identification numbers for the product. Record the information in the spaces provided below.

DATE OF PURCHASE:

\_\_\_\_\_

DEALER NAME:

\_\_\_\_\_

DEALER PHONE:

\_\_\_\_\_

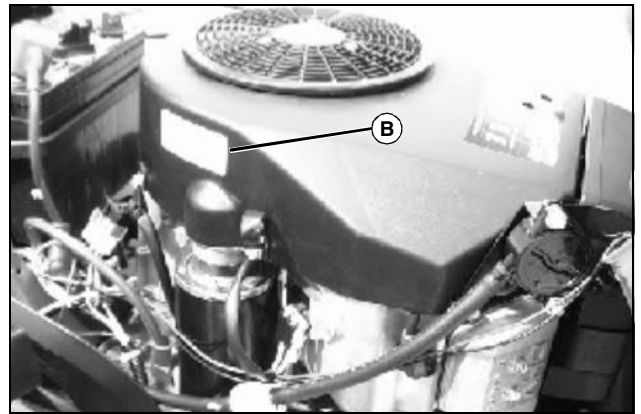

MX11154

**Picture Note: LT180 engine**

ENGINE SERIAL NUMBER (B):

-----

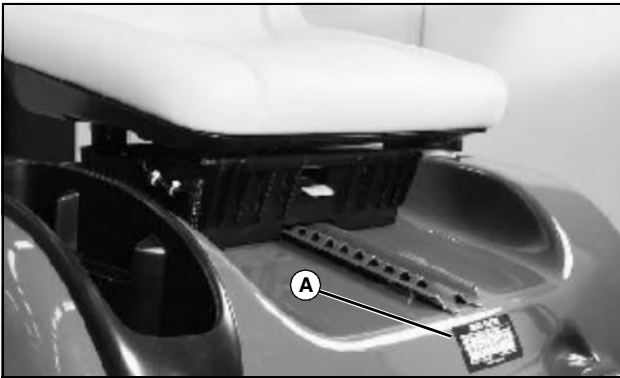

MX7541

PRODUCT IDENTIFICATION NUMBER (A):

-----



MX11152

**Picture Note: LT170 engine**

# TABLE OF CONTENTS

---

Safety .....	1
Operating .....	8
Replacement Parts .....	23
Service Intervals .....	24
Service Lubrication .....	25
Service Engine .....	27
Service Transmission .....	34
Service Mower .....	35
Service Electrical .....	49
Service Miscellaneous .....	52
Troubleshooting .....	54
Storage .....	59
Assembly .....	61
Specifications .....	64
Warranty .....	67
Index .....	72

All information, illustrations and specifications in this manual are based on the latest information at the time of publication. The right is reserved to make changes at any time without notice.

COPYRIGHT© 2001  
Deere & Co.  
John Deere Worldwide Commercial and  
Consumer Equipment Division  
All rights reserved  
Previous Editions  
COPYRIGHT© 2000, 1999, 1998, 1997

OMM147259 J1 - English

# SAFETY

## Understanding The Machine Safety Labels



Safety Alert Symbol

The machine safety labels shown in this section are placed in important areas on your machine to draw attention to potential safety hazards.

On your machine safety labels, the words DANGER, WARNING, and CAUTION are used with this safety-alert symbol. DANGER identifies the most serious hazards.

The operator's manual also explains any potential safety hazards whenever necessary in special safety messages that are identified with the word, CAUTION, and the safety-alert symbol.

## WARNING: AVOID SERIOUS INJURY OR DEATH

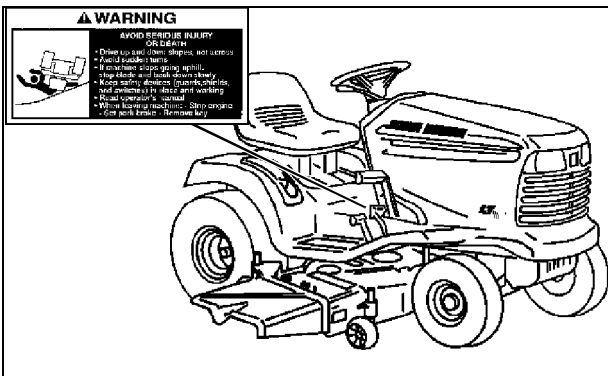

M47707a MX11148

- Drive up and down slopes, not across.
- Avoid sudden turns.
- If machine stops going uphill, stop blade and back down slowly.
- Keep safety devices (guards, shields, and switches) in place and working.
- Read Operator's Manual.
- When leaving machine: Stop engine, Set park brake, Remove key.

## DANGER: ROTATING BLADES CUT OFF ARMS AND LEGS

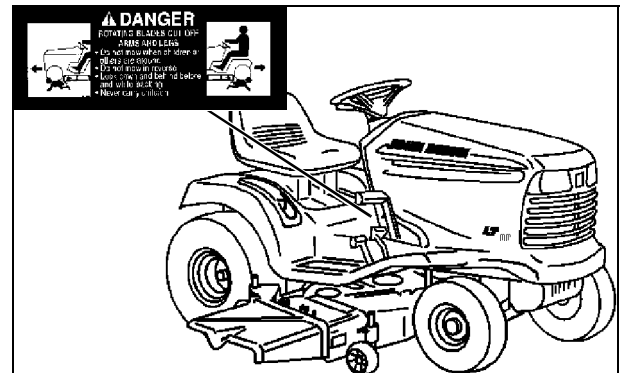

M47707b MX11148

- Do not mow when children or others are around.
- Do not mow in reverse.
- Look down and behind before and while backing.
- Never carry children even with the blades off.

## WARNING: LOADED SPRING (For Lift Assist)

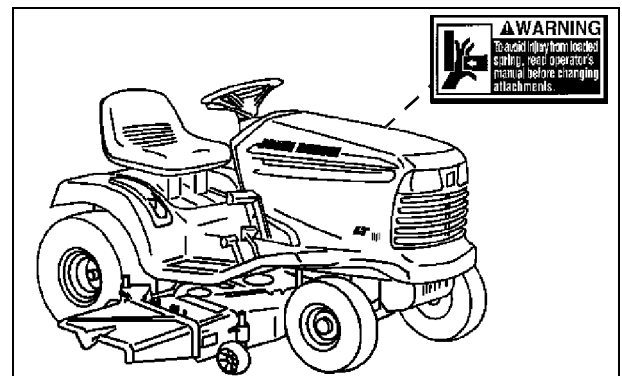

M88494 MX11148

**Picture Note: Label is located on both sides of deck when (optional) lift assist is installed**

- To avoid injury from loaded spring, read Operator's Manual before changing attachment.

# SAFETY

## DANGER: SHIELD EYES-EXPLOSIVE GASES CAN CAUSE BLINDNESS OR INJURY

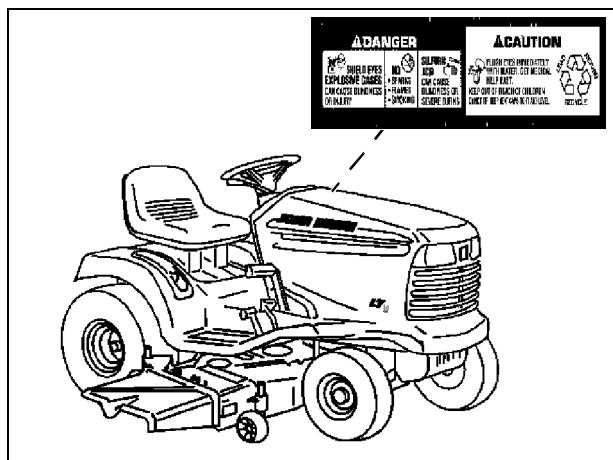

M88490 MX11148

**Picture Note:** Label is located on battery

- No sparks, flames, smoking.
- Sulfuric acid can cause blindness or severe burns.

CAUTION: Flush Eyes Immediately With Water

- Get medical help fast.
- Keep out of reach of children.
- Do not tip.
- Keep vent caps tight and level.

## DANGER: ROTATING BLADE

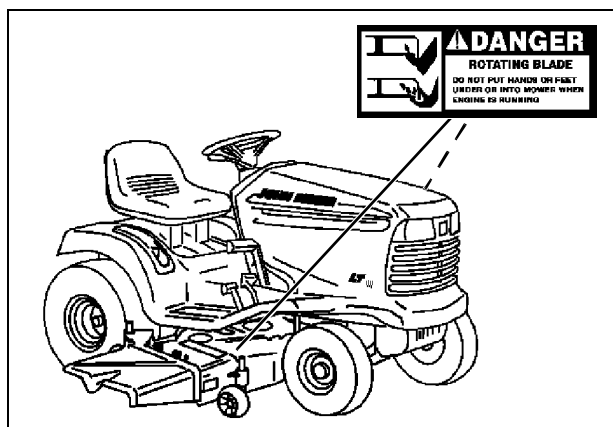

M38614 MX11148

**Picture Note:** 38-inch deck used for illustration. Decals are located on: left-hand side of all decks (and) right-hand side of Freedom42 deck

- Do not put hands or feet under or into mower when engine is running.

## DANGER: ROTATING BLADE

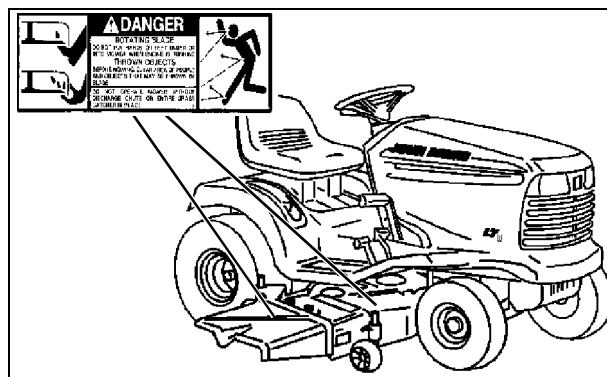

M38613 MX11148

**Picture Note:** Labels are located on discharge chute and right-hand side of 38-Inch, 42C, and 48C decks

- Do not put hands or feet under or into mower when engine is running.

### Thrown Objects

- Before mowing, clear area of objects that may be thrown by blade.
- Do not operate mower without discharge chute or entire grass catcher in place.

### Emission Control System Certification Label

**NOTE:** Tampering with emission controls and components by unauthorized personnel may result in severe fines or penalties. Emission controls and components can only be adjusted by EPA and/or CARB authorized service centers. Contact your John Deere Commercial and Consumer Equipment Retailer concerning emission controls and component questions.

The presence of an emissions label signifies that the engine has been certified with the United States Environmental Protection Agency (EPA) and/or California Air Resources Board (CARB).

The emissions warranty applies only to those engines marketed by John Deere that have been certified by the EPA and/or CARB; and used in the United States and Canada in off-road mobile equipment.

### Emission Compliance Period

If your engine has the emission compliance category listed on the emission control system certification or air index label, this indicates the number of operating hours for which

# SAFETY

the engine has been certified to meet EPA and/or CARB emission requirements. The following table provides the engine compliance period in hours associated with the category found on the certification label.

Agency	Category	Hours
EPA	C	250
EPA	B	500
EPA	A	1000
CARB	Moderate	125
CARB	Intermediate	250
CARB	Extended	500

## Certification

Your mower has been certified by an independent laboratory for compliance with American National Standard B-71.1, "Safety Specifications" for Power Lawn Mowers, Lawn and Garden Tractors, and Lawn Tractors.

## Operating Safely

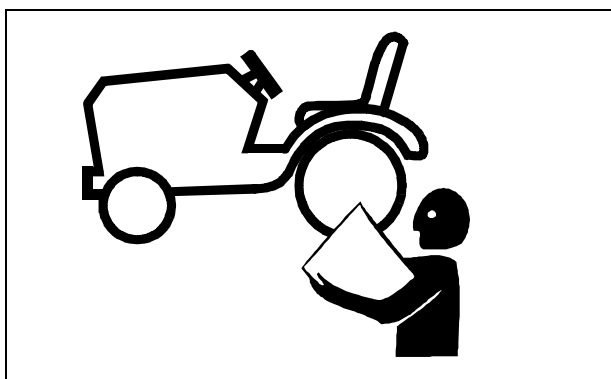

MIF

- Read, understand and follow all instructions in the manual, on the machine and on the safety video before starting.
- Only allow responsible adults, who are familiar with the instructions to operate the machine.
- Inspect machine before you operate. Be sure hardware is tight. Repair or replace damaged, badly worn, or missing parts. Be sure guards and shields are in good condition and fastened in place. Make any necessary adjustments before you operate.
- Do not operate mower without discharge chute or entire grass catcher in place.

- Check brake action before you operate. Adjust or service brakes as necessary.
- Stop machine if anyone enters the area.
- If you hit an object, stop the machine and inspect it. Make repairs before you operate. Keep machine and attachments properly maintained and in good working order.
- Be aware of the mower discharge direction and make sure that no one is in the path of the discharge direction.
- Do not leave machine unattended when it is running.
- Only operate during daylight or with good artificial light.
- Be careful of traffic when operating near or crossing roadways.
- Do not wear radio or music headphones while operating the machine. Safe operation requires your full attention.
- Older adults are involved in a large percentage of riding mower accidents involving injury. These operators should evaluate their ability to operate a mower safely enough to protect the operator and others from serious injury.

## Checking Mowing Area

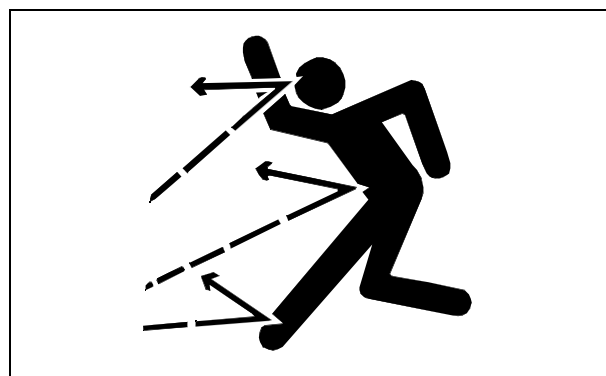

- Clear mowing area of objects that might be thrown. Keep people and pets out of mowing area.
- Study mowing area. Set up a safe mowing pattern. Do not mow where traction or stability is doubtful.
- Test drive area with mower lowered but not running. Slow down when you travel over rough ground.

## Parking Safely

1. Stop machine on a level surface, not on a slope.
2. Disengage mower blades.
3. Lower attachments to the ground.

# SAFETY

4. Lock the park brake.
5. Stop the engine.
6. Remove the key.
7. Wait for engine and all moving parts to stop before you leave the operator's seat.

## Rotating Blades are Dangerous

### HELP PREVENT SERIOUS OR FATAL ACCIDENTS:

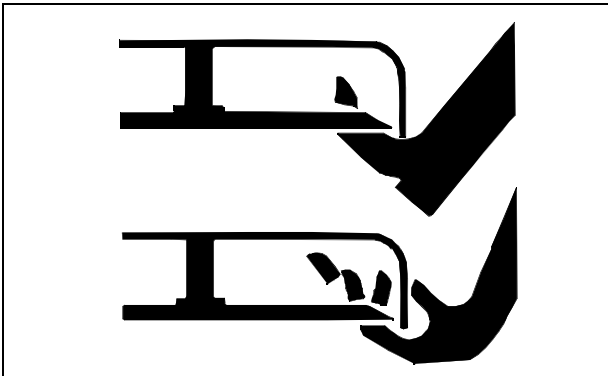

- Rotating blades can cut off arms and legs, and throw objects. Failure to observe safety instructions could result in serious injury or death.
- Keep hands, feet and clothing away from mower deck when engine is running.
- Be alert at all times, drive forward carefully. People, especially children can move quickly into the mowing area before you know it.
- Before backing up, stop mower blades or attachments and look down and behind the machine carefully, especially for children.
- Do not mow in reverse.
- Shut off blades when you are not mowing.
- Do not operate machine if you are under the influence of drugs or alcohol.
- Park machine safely before inspecting, removing, or unplugging mower or bagger.

### PROTECT CHILDREN:

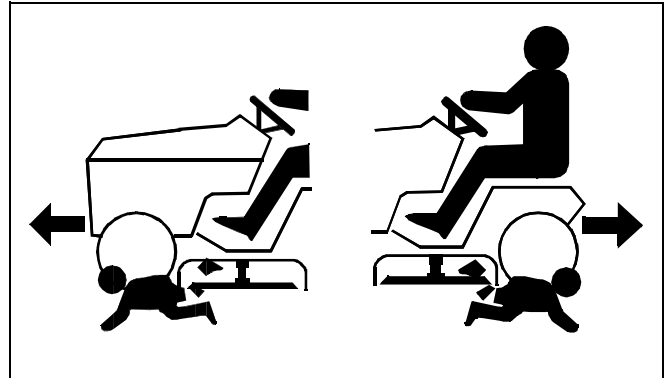

- Tragic accidents can occur if the operator is not alert to the presence of children. Keep children out of the mowing area and under the watchful care of another responsible adult.
- Never assume that children will remain where you last saw them. Children are attracted to mowing activity, stay alert to the presence of children.
- Keep children indoors when you are mowing. Turn the machine off if a child enters the mowing area.
- Use extra care when you come to blind corners, shrubs, trees, or other objects that may block your vision.
- Do not let children or an untrained person operate the machine.
- Do not carry or let children ride on any attachment or machine even with the blades off. Do not tow children in a cart or trailer.

## Avoid Tipping

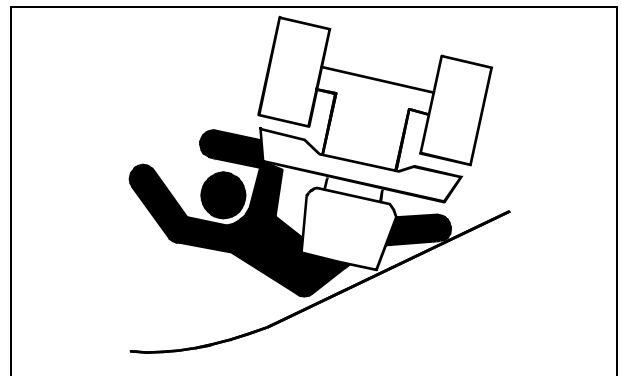

- Slopes are a major factor related to loss-of-control and tip-over accidents, which can result in severe injury or death. All slopes require extra caution. If you cannot back up the slope or if you feel uneasy on it, do not mow it.



# SAFETY

- Keep all movement on slopes slow and gradual. Do not make sudden changes in speed or direction.
- Slow down before you make a sharp turn or operate on a slope. Choose a low gear or speed so that you will not have to stop or shift while on the slope.
- Do not turn on slopes unless necessary. Turn slowly and turn downhill. Do not shift to neutral and coast downhill.
- Stay alert for holes and other hidden hazards in the terrain. Uneven terrain could overturn the machine. Tall grass can hide obstacles.
- Keep away from drop-offs, ditches and embankments.
- Use extra care with grass catchers or other attachments. These can change the stability of the machine. Do not use grass catcher on steep slopes.
- Use recommended weights for added stability when operating on slopes or using front or rear mounted attachments. Remove weights when not required.
- Drive up and down a hill - not across.
- Do not stop when going up hill or down hill. If machine stops going up hill, disengage mower blades and back down slowly.
- Mowing when grass is wet can cause reduced traction and sliding.
- Do not try to stabilize the machine by putting your foot on the ground.

## Keep Riders Off



MIF

- Only allow the operator on the machine. Keep riders off.
- Riders on the machine or attachment may be struck by foreign objects or thrown off the machine causing serious injury.
- Riders obstruct the operator's view resulting in the machine being operated in an unsafe manner.

## Wear Appropriate Clothing

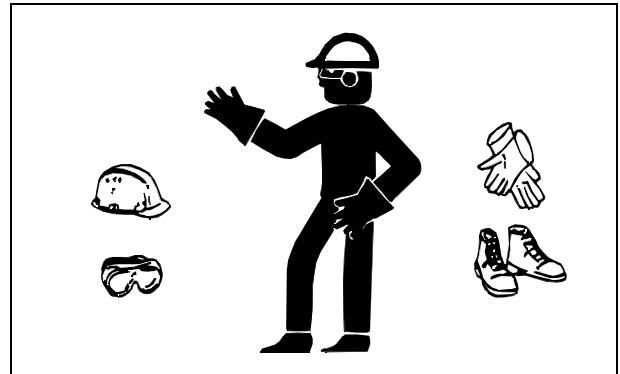

- Wear close fitting clothing and safety equipment appropriate for the job.
- Always wear safety goggles or safety glasses with side shields when operating the mower.
- Wear a suitable protective device such as earplugs. Loud noise can cause impairment or loss of hearing.
- Do not wear radio or music headphones. Safe service and operation requires your full attention.

## Driving Safely on Public Roads

Avoid personal injury or death resulting from a collision with another vehicle on public roads:

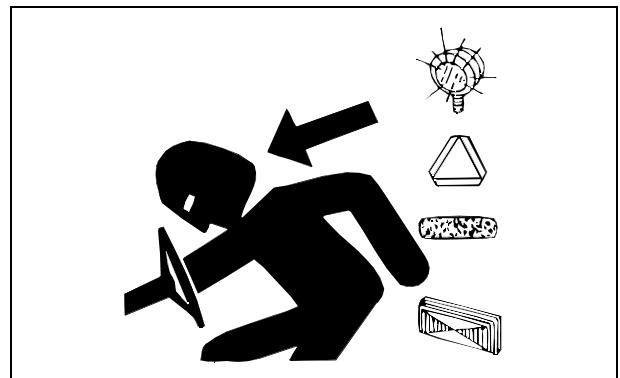

- Use safety lights and devices. Slow moving machines when driven on public roads are hard to see, especially at night.
- Whenever driving on public roads, use flashing warning lights and turn signals according to local regulations. Extra flashing warning lights may need to be installed.

**Thank you very much  
for your reading.**

**Please click here and go  
back to the website.**

**Then, you can  
download the complete  
manual instantly.**

**No waiting.**