

JOHN DEERE
WORLDWIDE COMMERCIAL & CONSUMER
EQUIPMENT DIVISION

Spin-Steer Lawn Tractor
SST16 and SST18

OMM145531 L0

OPERATOR'S MANUAL



JOHN DEERE

 **WARNING:** The Engine Exhaust from this product contains chemicals known to the State of California to cause cancer, birth defects or other reproductive harm.

California Proposition 65 Warning

North American Version
Litho in U.S.A.

INTRODUCTION

Thank You for Purchasing a John Deere Product

We appreciate having you as a customer and wish you many years of safe and satisfied use of your machine.

Using Your Operator's Manual

This manual is an important part of your machine and should remain with the machine when you sell it.

Reading your operator's manual will help you and others avoid personal injury or damage to the machine. Information given in this manual will provide the operator with the safest and most effective use of the machine. Knowing how to operate this machine safely and correctly will allow you to train others who may operate this machine.

This manual and safety signs on your machine may also be available in other languages (see your John Deere dealer to order).

Sections in your operator's manual are placed in a specific order to help you understand all the safety messages and learn the controls so you can operate this machine safely. You can also use this manual to answer any specific operating or servicing questions. A convenient index located at the end of this book will help you to find needed information quickly.

The machine shown in this manual may differ slightly from your machine, but will be similar enough to help you understand our instructions.

RIGHT-HAND and LEFT-HAND sides are determined by facing in the direction the machine will travel when going forward. When you see a broken line arrow (----->), the item referred to is hidden from view.

Before delivering this machine, your dealer performed a predelivery inspection to ensure best performance.

Special Messages

Your manual contains special messages to bring attention to potential safety concerns, machine damage as well as helpful operating and servicing information. Please read all the information carefully to avoid injury and machine damage.



CAUTION: Avoid injury! This symbol and text highlight potential hazards or death to the operator or bystanders that may occur if the hazards or procedures are ignored.

IMPORTANT: Avoid damage! This text is used to tell the operator of actions or conditions that might result in damage to the machine.

NOTE: General information is given throughout the manual that may help the operator in the operation or service of the machine.

PRODUCT IDENTIFICATION

Record Identification Numbers

Spin-Steer Lawn Tractor

SST16 and SST18

PIN (010001-)

If you need to contact an Authorized Service Center for information on servicing, always provide the product model and identification numbers.

You will need to locate the model and identification numbers for the product and record the information in the spaces provided below.

DATE OF PURCHASE:

DEALER NAME:

DEALER PHONE:

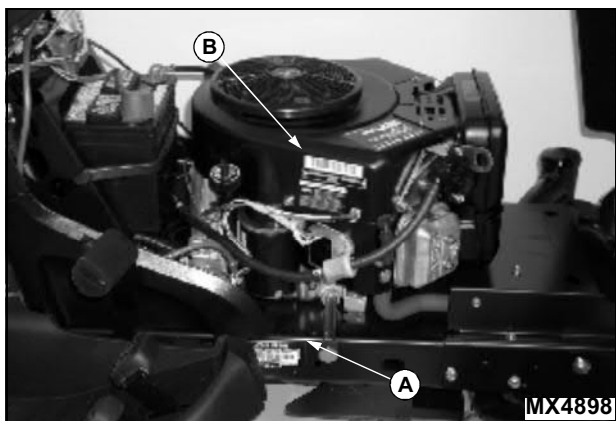

- PRODUCT IDENTIFICATION NUMBER (A):

- ENGINE SERIAL NUMBER (B):

TABLE OF CONTENTS

Safety	1
Operating	10
Replacement Parts	27
Service Intervals	28
Service Lubrication	29
Service Engine	30
Service Transmission.....	35
Service Steering	36
Service Mower	38
Service Electrical	53
Service Miscellaneous.....	56
Troubleshooting	58
Storage	62
Assembly	64
Specifications	66
Warranty	69
Index.....	73

All information, illustrations and specifications in this manual are based on the latest information at the time of publication. The right is reserved to make changes at any time without notice.

COPYRIGHT© 2000
Deere & Co.

John Deere Worldwide Commercial and
Consumer Equipment Division
Horicon, WI

All rights reserved
Previous Editions
COPYRIGHT©

OMM145531 L0 - English

SAFETY

Understanding The Machine Safety Labels



The machine safety labels shown in this section are placed in important areas on your machine to draw attention to potential safety hazards.

On your machine safety labels, the words **DANGER**, **WARNING**, and **CAUTION** are used with this safety-alert symbol, (▲). **DANGER** identifies the most serious hazards.

The operator's manual also explains any potential safety hazards whenever necessary in special safety messages that are identified with the word, **CAUTION**, and the safety-alert symbol, (▲).

DANGER: ROTATING BLADES CUT OFF ARMS AND LEGS



- Do not mow when children or others are around
- Do not mow in reverse
- Look down and behind before and while backing
- Never carry children - even with blades off

WARNING: AVOID SERIOUS INJURY OR DEATH



- Drive up and down slopes, not across
- Avoid sudden turns
- If machine stops going uphill, stop blade and back down slowly
- Keep safety devices (guards, shields, and switches) in place and working
- Read operator's manual
- When leaving machine:
 - Stop engine
 - Set park brake
 - Remove key
- Do not drive where machine could slip or tip
- Remove objects that could be thrown by blade

SAFETY

WARNING: LOADED SPRING



Picture Note: Two decals, one on each mower deck lift bracket. 48C shown.

- To avoid injury from loaded spring, read operator's manual before changing attachments.

DANGER - CAUTION: POISON



Picture Note: Located on Battery

- Shield eyes, explosive gases can cause blindness or injury.
- No sparks, flames, smoking.
- Sulfuric acid can cause blindness or severe burns.
- Flush eyes immediately with water. Get medical help fast.
- Keep out of reach of children.
- Do not tip.
- Keep vent caps tight and level.

WARNING



Picture Note: Label is located on engine.

- Read and follow Operating Instructions before running engine.
- Gasoline is flammable. Allow engine to cool at least 2 minutes before refueling.
- Engines emit carbon monoxide, DO NOT run in enclosed area.

SAFETY

DANGER: ROTATING BLADE

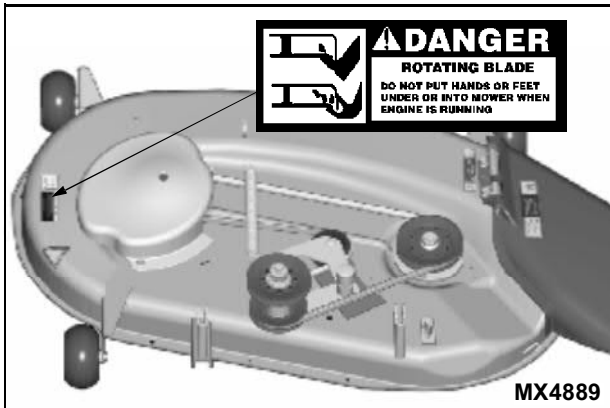

Picture Note: On 42 All Purpose and 48C: One decal on left side of mower deck. 42 All Purpose deck is used for photo purposes.

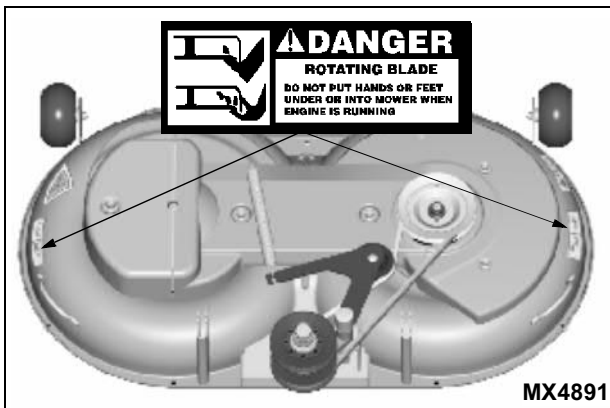

Picture Note: On Freedom42: Two decals, one on each side of mower deck.

Do not put hands or feet under or into mower when engine is running.

DANGER: ROTATING BLADE - THROWN OBJECTS

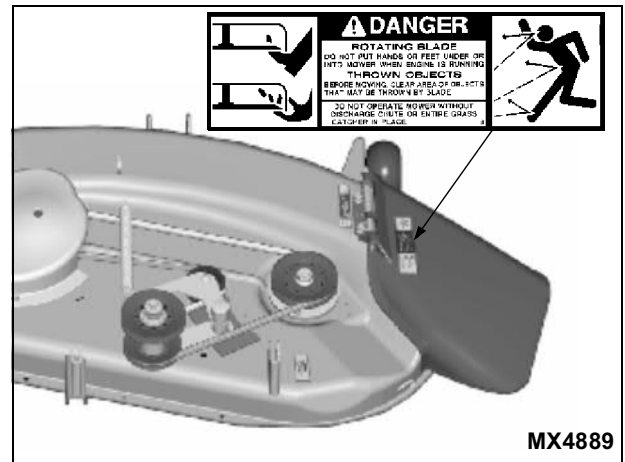

Picture Note: On 42 All Purpose: One decal on mower deck discharge chute.

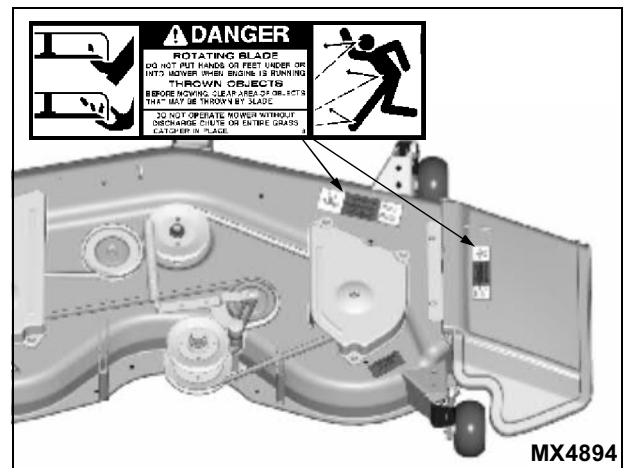

Picture Note: On 48C: Two decals, one on discharge chute and one on right side of mower deck.

- Do not put hands or feet under or into mower when engine is running.
- Before mowing, clear area of objects that may be thrown by blade.
- Do not operate mower without discharge chute or entire grass catcher in place.

SAFETY

DANGER

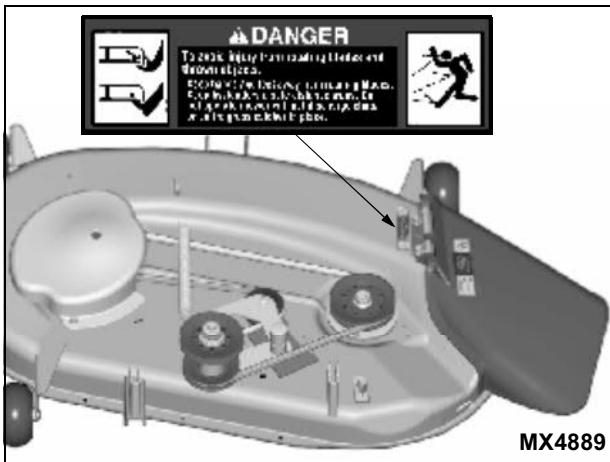

Picture Note: On 42 All Purpose: One decal on right side of mower deck.

- To avoid injury from rotating blades and thrown objects:
- Keep hands and feet away from rotating blades.
- Keep bystanders a safe distance away.
- Do not operate mower without discharge chute or entire grass catcher in place.

Emission Control System Certification Label

NOTE: Tampering with emission controls and components by unauthorized personnel may result in severe fines or penalties. Emission controls and components can only be adjusted by EPA and/or CARB authorized service centers. Contact your John Deere Commercial and Consumer Equipment Retailer concerning emission controls and component questions.

The presence of an emissions label signifies that the engine has been certified with the United States Environmental Protection Agency (EPA) and/or California Air Resources Board (CARB).

The emissions warranty applies only to those engines marketed by John Deere that have been certified by the EPA and/or CARB; and used in the United States and Canada in off-road mobile equipment.

Emission Compliance Period

If your engine has the emission compliance category listed on the emission control system certification or air index label, this indicates the number of operating hours for which the engine has been certified to meet EPA and/or

CARB emission requirements. The following table provides the engine compliance period in hours associated with the category found on the certification label.

Agency	Category	Hours
EPA	C	250
EPA	B	500
EPA	A	1000
CARB	Moderate	125
CARB	Intermediate	250
CARB	Extended	500

Certification

Your mower has been certified by an independent laboratory for compliance with American National Standard B-71.1, "Safety Specifications" for Power Lawn Mowers, Lawn and Garden Tractors, and Lawn Tractors.

Operating Safely

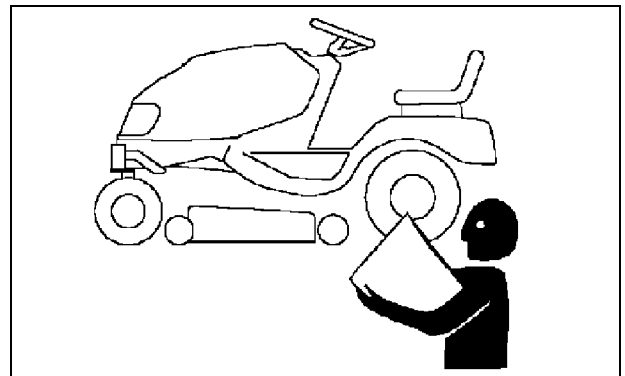

- Read, understand and follow all instructions in the manual and on the machine before starting. In addition to reading your Operator's Manual, view your Mowing Safety Tips Video.
- Practice operating the Spin-Steer in a large open area with the blades off. Keep practicing until you feel confident in your maneuvering and driving skills.
- Only allow responsible adults, who have practiced driving and are familiar with the instructions to operate the machine.
- Inspect machine before you operate. Be sure hardware is tight. Repair or replace damaged, badly worn, or missing parts. Be sure guards and shields are in good condition

SAFETY

and fastened in place. Make any necessary adjustments before you operate.

- Check brake action before you operate. Adjust or service brakes as necessary.
- Stop machine if anyone enters the area.
- If you hit an object, stop the machine and inspect it. Make repairs before you operate. Keep machine and attachments properly maintained and in good working order.
- Be aware of the mower discharge direction and make sure that no one is in the path of the discharge direction.
- Do not leave machine unattended when it is running.
- Only operate during daylight or with good artificial light.
- Be careful of traffic when operating near or crossing roadways.
- Do not wear radio or music headphones while operating the machine. Safe operation requires your full attention.
- Older adults are involved in a large percentage of riding mower accidents involving injury. These operators should evaluate their ability to operate a mower safely enough to protect the operator and others from serious injury.

Avoid Tipping

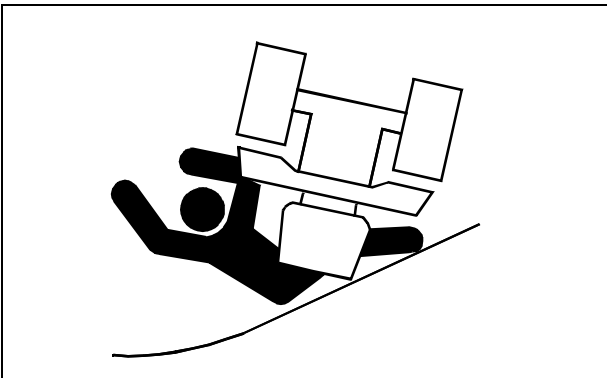

- Slopes are a major factor related to loss-of-control and tip-over accidents, which can result in severe injury or death. Because this tractor operates so differently we absolutely do not recommend mowing on slopes greater than a ten-degree gradual rise.
- Do not drive where machine could slip or tip.
- Keep away from drop-offs, steep slopes, ditches and embankments. The machine could suddenly turn over if a wheel is over the edge of a drop-off or steep slope.
- Stay alert for holes and other hidden hazards in the terrain.
- Slow down before you operate on a slope. Do not stop

or change speed suddenly while on a slope.

- Never turn on a slope or make sudden changes in speed or direction.
- Drive up and down a hill - not across.
- Do not stop when going up hill or down hill. If machine stops going up hill, disengage mower blades and back straight down slowly.
- Use recommended rear wheel weights or front weights for added stability when using front or rear mounted attachments or grass catchers. Remove weights when not required.
- Do not mow wet grass. Mowing when grass is wet can cause reduced traction and sliding.
- Do not try to stabilize the machine by putting your foot on the ground.

Checking Mowing Area

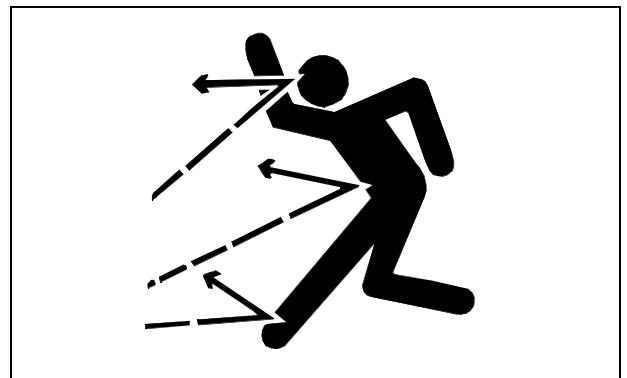

- Clear mowing area of objects that might be thrown. Keep people and pets out of mowing area.
- Study mowing area. Set up a safe mowing pattern. Do not mow where traction or stability is doubtful.
- Test drive area with mower lowered but not running. Slow down when you travel over rough ground.

Parking Safely

1. Stop machine on a level surface, not on a slope.
2. Disengage mower blades.
3. Lower attachments to the ground.
4. Lock the park brake.
5. Stop the engine.
6. Remove the key.
7. Wait for engine and all moving parts to stop before you

SAFETY

leave the operator's seat.

Rotating Blades are Dangerous

HELP PREVENT SERIOUS OR FATAL ACCIDENTS:

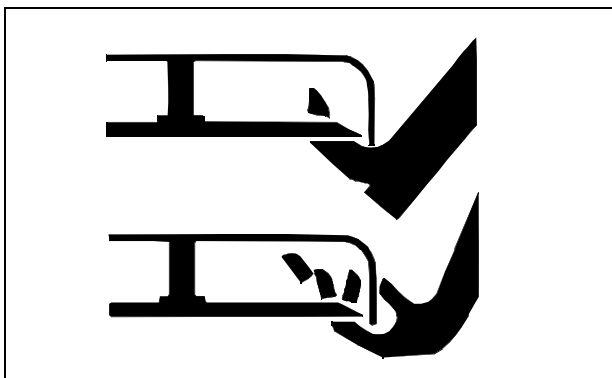

- Rotating blades can cut off arms and legs.
- Keep hands, feet and clothing away from mower deck when engine is running.
- Be alert at all times, drive forward carefully. People, especially children can move quickly into the mowing area before you know it.
- Before backing up, shut off PTO and look down and behind the machine carefully, especially for children.
- Do not mow in reverse.
- Shut off blades when you are not mowing.
- Do not operate machine if you are under the influence of drugs or alcohol.
- Park machine safely before inspecting or unplugging mower or bagger.

PROTECT CHILDREN:

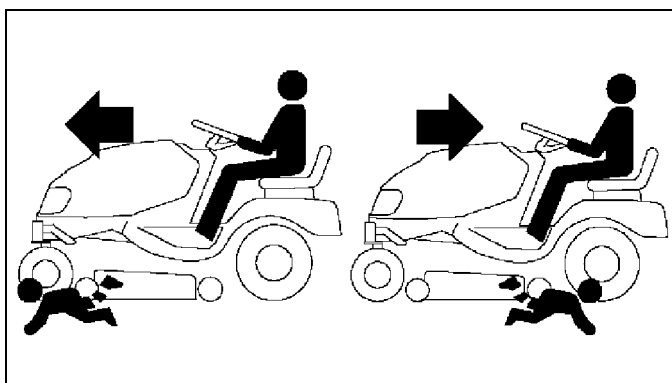

- Never assume that children will remain where you last saw them. Children are attracted to mowing activity, stay alert to the presence of children.

- Keep children indoors when you are mowing. Turn the machine off if a child enters the mowing area.
- Use extra care when you come to blind corners, shrubs, trees, or other objects that may block your vision.
- Do not let children or an untrained person operate the machine.
- Do not carry or let children ride on any attachment or machine even with the blades off. Do not tow children in a cart or trailer.

Keep Riders Off

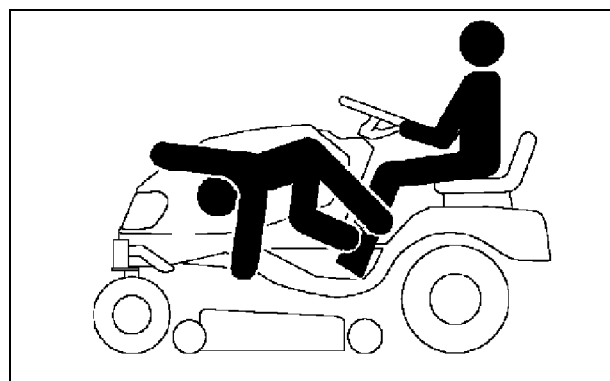

- Only allow the operator on the machine. Keep riders off.
- Riders on the machine or attachment may be struck by foreign objects or thrown off the machine causing serious injury.
- Riders obstruct the operator's view resulting in the machine being operated in an unsafe manner.

Towing Loads Safely

- Do not tow children in a cart or trailer.
- Limit loads to those you can safely control. Use only approved hitches when pulling loads or using heavy equipment.
- Travel slowly and allow extra distance to stop.
- Follow the manufacturer's recommendation for weight limits for towed equipment and towing on slopes.
- Tow only with a machine that has a hitch designed for towing. Do not attach towed equipment except at the hitch point.
- On slopes, the weight of towed equipment may cause loss of traction and loss of control.

SAFETY

Wear Appropriate Clothing

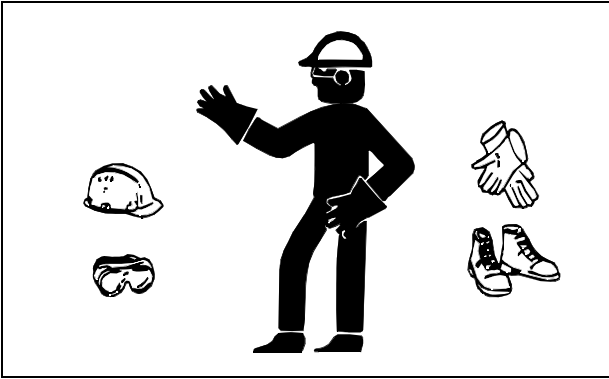

- Wear close fitting clothing and safety equipment appropriate for the job.
- Always wear safety goggles or safety glasses with side shields when operating the mower.
- Wear a suitable protective device such as earplugs. Loud noise can cause impairment or loss of hearing.
- Do not wear radio or music headphones. Safe service and operation requires your full attention.

Driving Safely on Public Roads

Avoid personal injury or death resulting from a collision with another vehicle on public roads:

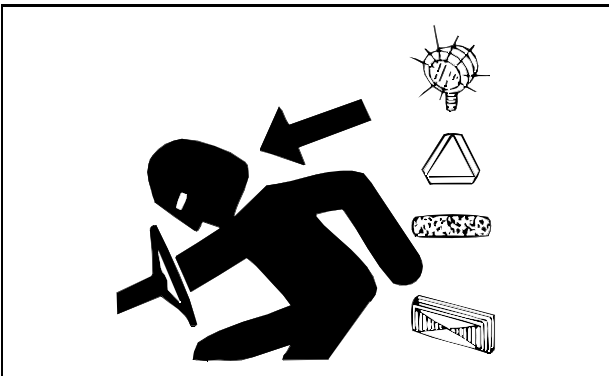

- Use safety lights and devices. Slow moving machines when driven on public roads are hard to see, especially at night.
- Whenever driving on public roads, use flashing warning lights and turn signals according to local regulations. Extra flashing warning lights may need to be installed.

Practice Safe Maintenance



- Understand service procedure before doing work. Keep area clean and dry.
- Never lubricate, service, or adjust machine while it is moving. Keep safety devices in place and in working condition. Keep hardware tight.
- Keep hands, feet, clothing, jewelry, and long hair away from any moving parts, to prevent them from getting caught.
- Lower attachments to the ground before servicing machine. Disengage all power and stop the engine. Lock park brake and remove the key. Let machine cool.
- Disconnect battery or remove spark plug wire before making any repairs.
- Keep all nuts and bolts tightened, especially blade attachment bolts.
- Securely support any machine elements that must be raised for service work.
- Never run engine unless park brake is locked.
- Keep all parts in good condition and properly installed. Fix damage immediately. Replace worn or broken parts. Replace all worn or damaged safety and instruction decals.
- To prevent fires, remove any buildup of grease, oil, or debris from the machine, especially the engine compartment.
- Charge batteries in an open, well-ventilated area, away from sparks. Unplug battery charger before connecting or disconnecting from the battery. Use insulated tools.
- Do not modify machine or safety devices. Unauthorized modifications may impair its function and safety.
- Do not wear radio or music headphones while servicing the machine. Safe service requires your full attention.

**Thank you very much
for your reading.**

**Please click here and go
back to the website.**

**Then, you can
download the complete
manual instantly.**

No waiting.