

# Walk-Behind Snowblowers 828D and 1032D

Serial No. (190001 - )

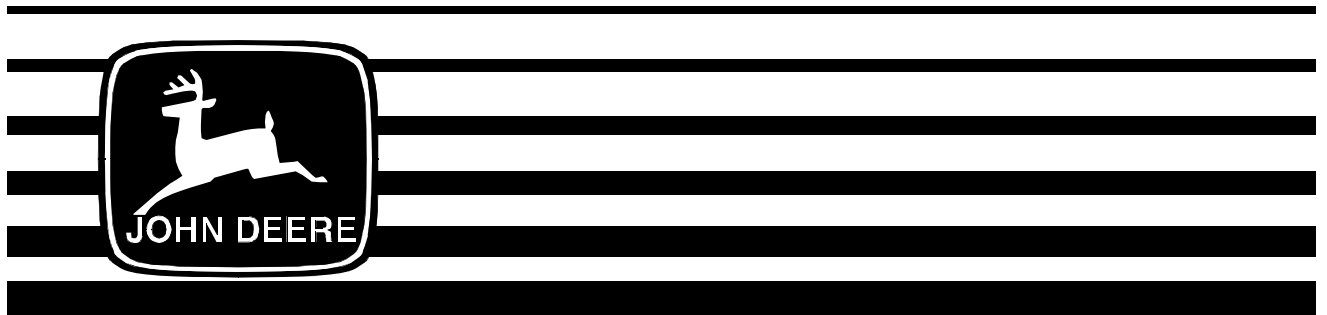

## OPERATOR'S MANUAL

John Deere  
Worldwide Commercial And  
Consumer Equipment Division  
OMM140487 E9

North American Version  
Litho in U.S.A.

English

# INTRODUCTION

**THANK YOU** for purchasing a John Deere product.

Read this manual and your attachment manuals thoroughly. Failure to do so could result in personal injury or equipment damage.

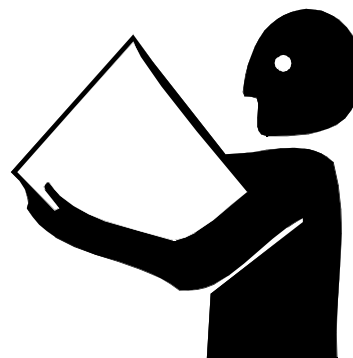

**WARNING:** The Engine Exhaust from this product contains chemicals known to the State of California to cause cancer, birth defects or other reproductive harm.

CALIFORNIA Proposition 65 Warning

This manual should be considered a permanent part of your machine and should remain with the machine when you sell it.

Measurements in this manual are metric units and their U.S. customary equivalents. RIGHT-HAND and LEFT-HAND sides are determined by facing in the direction the machine will travel when going forward. When you see a broken line arrow ( ---->) it indicates the part it is pointing to is hidden.

Record identification numbers below. Be sure to record all the numbers to help in tracing the machine if it is stolen. You also need to give these numbers to your dealer when you order parts.

**Date Of Purchase:**

\_\_\_\_\_

**Dealer Name:**

\_\_\_\_\_

**Dealer Phone:**

\_\_\_\_\_

**Product Identification Number (A):**

-----

**Engine Serial Number (B):**

-----

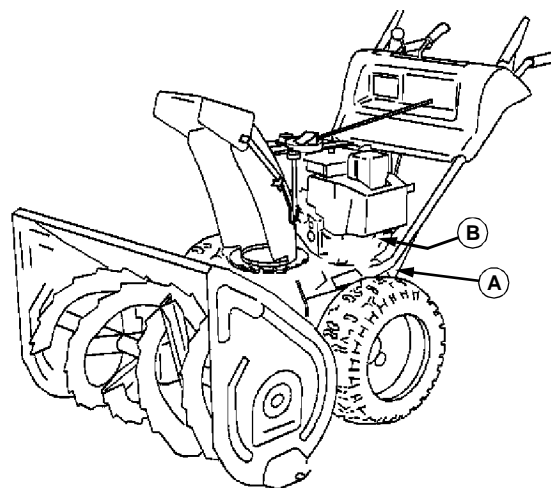

---

---

# TABLE OF CONTENTS

---

---

Safety Signs . . . . .	1
Controls . . . . .	3
Operating . . . . .	5
Replacement Parts . . . . .	21
Service Machine Safely . . . . .	22
Service Interval Chart . . . . .	24
Service . . . . .	26
Troubleshooting . . . . .	52
Storage . . . . .	54
Assembly . . . . .	57
Specifications . . . . .	66
Warranty . . . . .	68
Index . . . . .	73
Service Literature Order Form . . . . .	77

All information, illustrations and specifications in this manual are based on the latest information at the time of publication. The right is reserved to make changes at any time without notice.

COPYRIGHT© 1999  
Deere & Co.  
John Deere Worldwide Commercial and  
Consumer Equipment Division  
Horicon, WI  
All rights reserved  
Previous Editions  
COPYRIGHT© 1998

OMM140487 E9

# NOTES

---

---

# SAFETY SIGNS

## Safety-Alert Symbol

Read and recognize safety information. Be alert to the potential for personal injury when you see this safety-alert symbol.

On your machine safety labels, the words DANGER, WARNING, and CAUTION are used with this safety-alert symbol. DANGER identifies the most serious hazards. In this manual, the word CAUTION and this symbol call attention to safety messages.



## DANGER

To avoid injury from rotating auger and thrown objects, stay clear of machine and keep others away. Keep all shields in place. Read operator's manual.



## DANGER - ROTATING BLOWER

Shut off engine before unclogging discharge chute.



# SAFETY SIGNS

## WARNING - HOT SURFACE

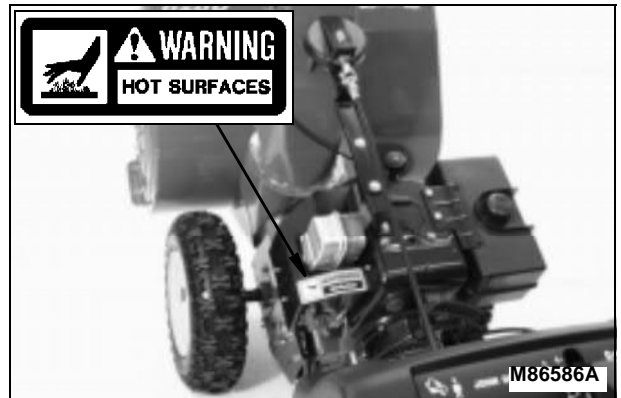

## Certification Label

This OPEI label on your snow blower indicates that this model has been certified by an independent laboratory for compliance with American National Standard B-71.3-1995, "Safety Specifications" for Snowblowers.

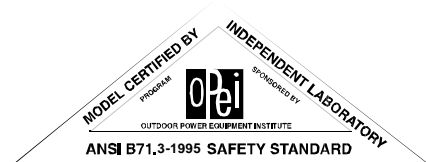

# CONTROLS

## Engine Controls

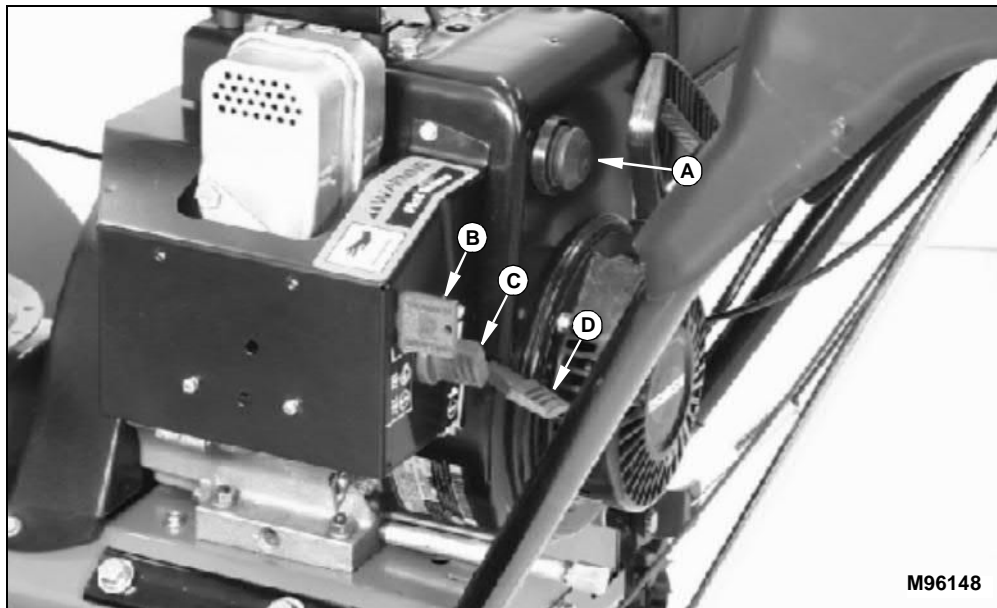

- A - Primer Bulb
- B - Key
- C - Choke Knob
- D - Throttle Lever
- E - Starter Handle
- F - Fuel Shut-Off Knob

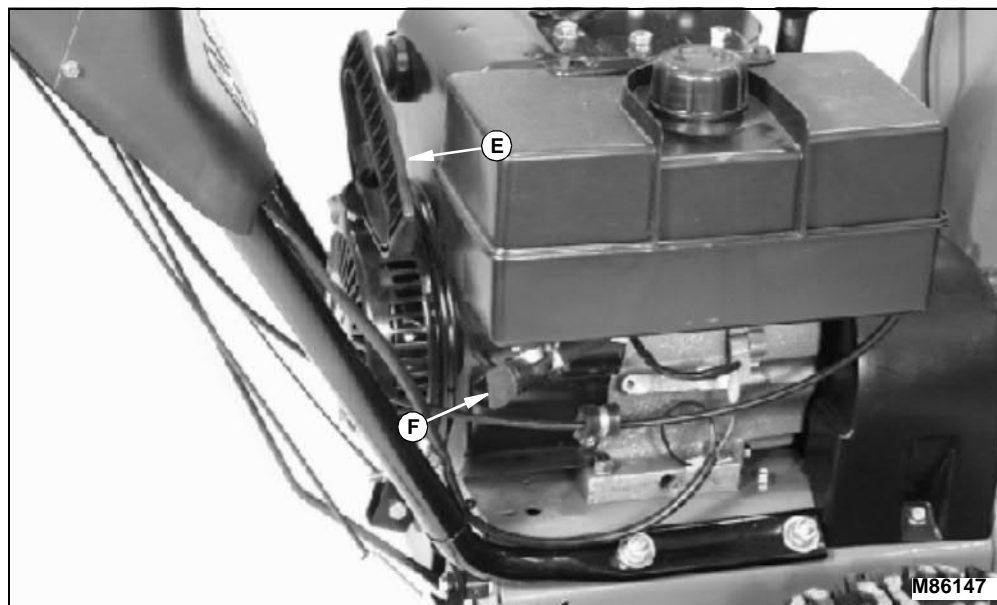

# CONTROLS

## Handle Controls

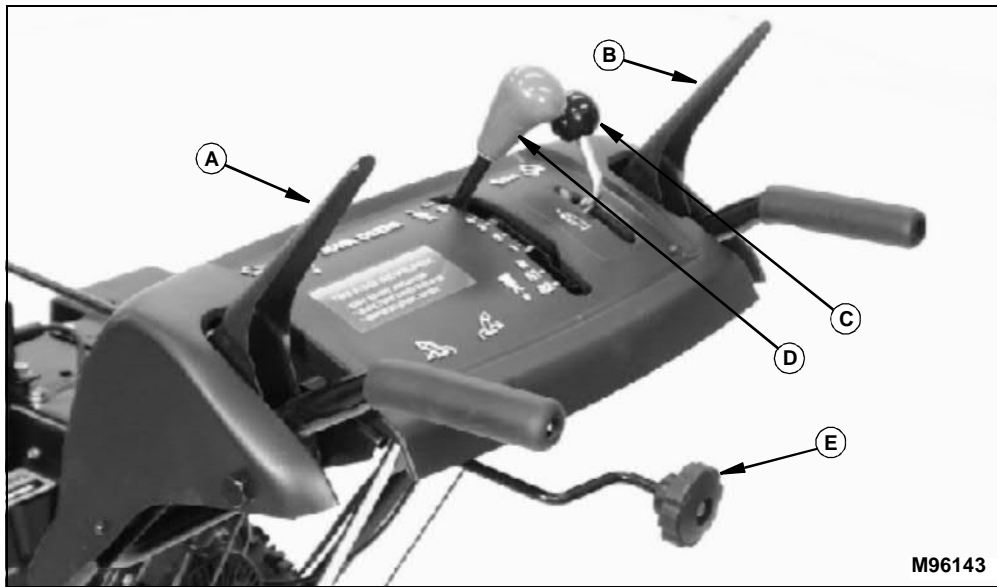

- A - Traction Drive Lever
- B - Auger Drive Lever
- C - Chute Deflector Lever
- D - Speed Selector Lever
- E - Discharge Chute Control

## Miscellaneous Controls

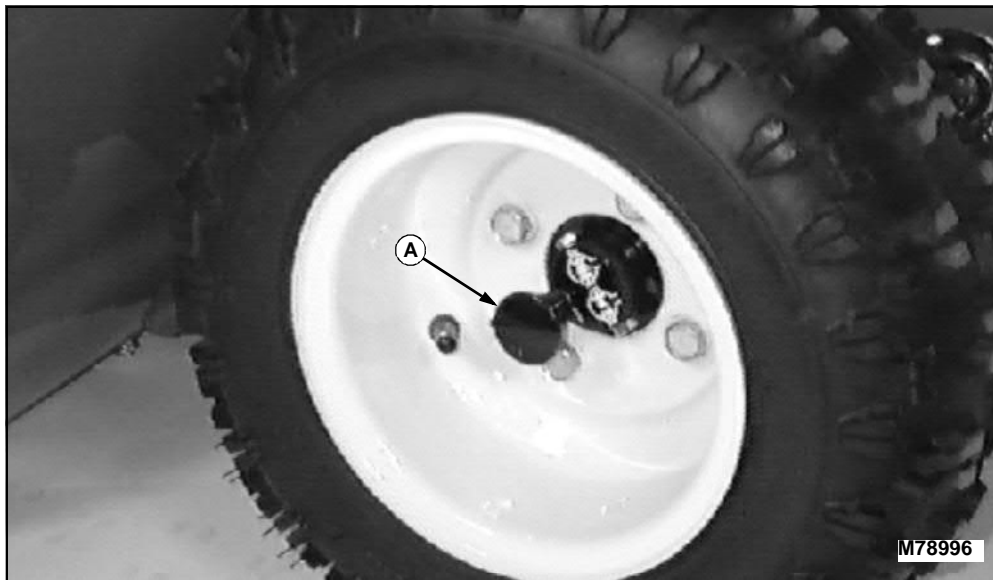

- A - Differential Lock



# OPERATING

---

## Operate Safely

- Inspect machine before you operate. Be sure hardware is tight. Repair or replace damaged, badly worn, or missing parts. Be sure guards and shields are in good condition and fastened in place. Make any necessary adjustments before you operate.
- Clear work area of objects that might be thrown. Keep people and pets out of the work area. Stop machine if anyone enters the area.
- If you hit an object, stop the machine and inspect it. Make repairs before you operate. Keep machine properly maintained and in good working order. Keep all shields and guards in place.
- DO NOT blow snow toward people, cars, or buildings.
- DO NOT use snowblower on surfaces above ground level, such as, a roof of a building.
- Be extremely careful if you must clear snow from a gravel path. Be aware that snowblower may pick up gravel in snow. Adjust spout angle carefully to blow this snow safely.
- DO NOT leave machine unattended when it is running.
- Only operate during daylight or with good artificial light.
- Be sure of footing. Operate slowly on slippery surfaces. Be especially careful when you pull machine backwards with the engine running.
- DO NOT blow snow across a slope. Be careful when you change direction on a slope. Do not try to clear snow from steep slopes. Keep away from edge of a ditch or bank.
- Keep a firm hold on the machine handles. Avoid sudden starts and stops.
- DO NOT run engine in a building unless there is good ventilation.

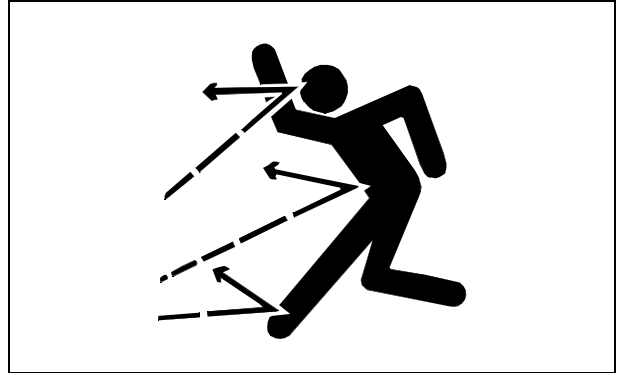

## OPERATING

### Rotating Blades Are Dangerous - Protect Children And Prevent Accidents

#### PROTECT CHILDREN:

- Never assume that children will remain where you last saw them. Children are attracted to snow blowing activity, stay alert to the presence of children.
- Keep children in the house when you are operating the machine.
- Turn machine off if a child enters the area.
- Use extra care when you come to blind corners, shrubs, trees, or other objects that may block your vision.
- DO NOT let children or an untrained person operate the machine.

#### HELP PREVENT SERIOUS OR FATAL ACCIDENTS:

- Be alert at all times, people ESPECIALLY CHILDREN can move quickly into the area before you know it.
- Shut off auger when you are not blowing snow.
- Keep hands, feet, and clothing away from moving parts.

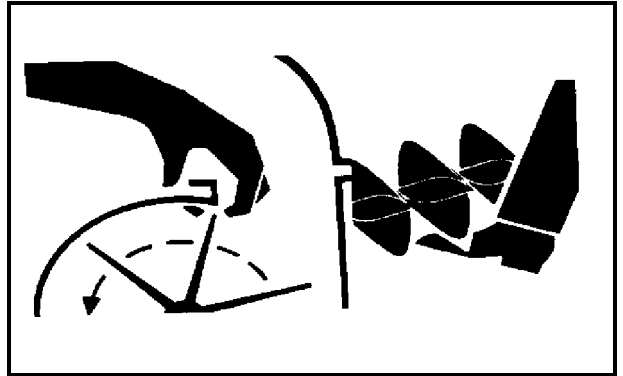

### Wear Appropriate Clothing

- Wear close fitting clothing and safety equipment appropriate for the job.
- Loud noise can cause impairment or loss of hearing, wear a suitable protective device such as earplugs.

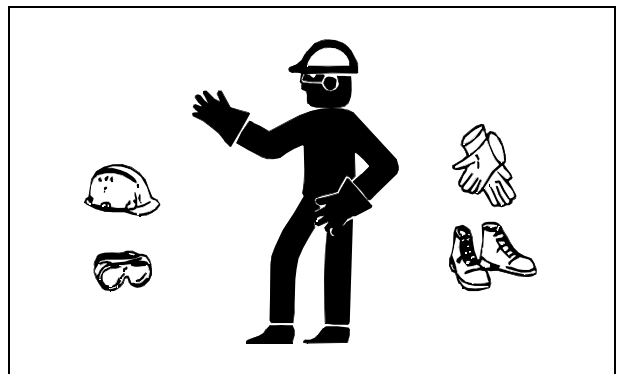

# OPERATING

## Adjusting Scraper Blade

**IMPORTANT:** If scraper blade wears too far auger/impeller housing may be damaged.

1. Park snowblower on a hard, smooth surface.
2. Stop engine, remove key, wait for all moving parts to stop.
3. Remove wire from spark plug to prevent accidental starting.
4. Tip unit back onto handle bars and support housing.
5. Adjust skid shoes to their FULL UP position.
6. Inspect scraper blade (A):
  - If scraper blade has excessive wear, replace it.
  - If scraper blade can be adjusted; loosen nuts and reposition scraper blade, flush with skid shoes.
7. Tighten nuts.
8. Adjust skid shoes to the proper height. (See Adjusting Skid Shoes in this section).

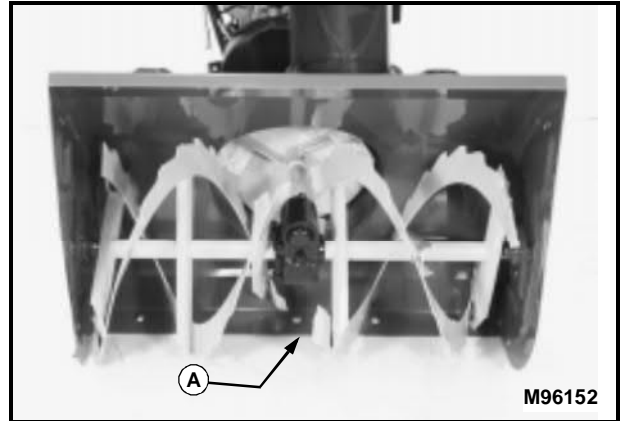

# OPERATING

## Adjusting Skid Shoes

Adjust skid shoe height for proper working conditions:

- **To operate on a smooth, hard surface:** Adjust skid shoes so there is 3mm (1/8 in.) between scraper blade and surface.
- **To operate on gravel or uneven surface:** Adjust skid shoes so there is 30mm (1-1/4 in.) between scraper blade and surface.
- **To operate on hard packed snow:** Remove skid shoes and install them upside down. This will prevent the snowblower from riding up on the snow. Adjust skid shoes so there is 3mm (1/8 in.) between scraper blade and surface.

1. Park snowblower on a hard, smooth surface.
2. Stop engine, remove key, wait for all moving parts to stop.
3. Remove wire from spark plug to prevent accidental starting.
4. Check tires:
  - Air pressure in both tires should be equal, although some machine leveling can be made by using different pressures.
  - Each tire must be resting on hard surface, not a cross-link of tire chain.
5. Put a block under auger housing.
6. Inspect skid shoes:
  - If skid shoes have excessive wear, replace them.
  - If skid shoes can be adjusted; loosen two nuts (A) and move skid shoe (B) to desired position.
  - Tighten nuts. Adjust other skid shoe to the same height.

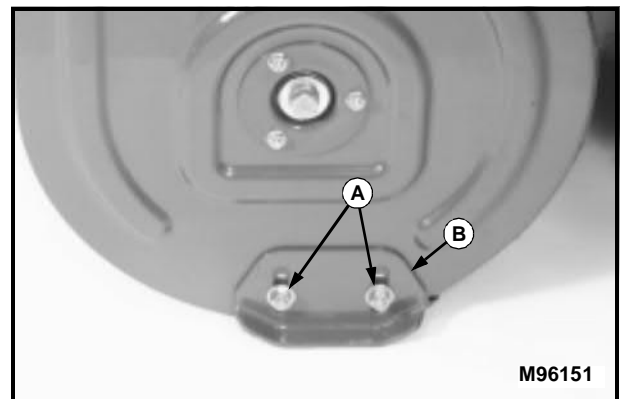

# OPERATING

## Using Drive Control Levers

### TRACTION DRIVE LEVER (A):

- Pull lever (A) to handle to ENGAGE the traction drive.
- Release lever to DISENGAGE traction drive.
- If auger drive lever (B) is also ENGAGED, you can release lever (B), auger drive will stay in the ENGAGED position. Release traction drive lever and both traction drive and auger drive will DISENGAGE.
- Traction drive lever (A) will work independently from the auger drive lever.

### AUGER DRIVE LEVER (B):

- Pull lever (B) to handle to ENGAGE the auger drive.
- Release lever to DISENGAGE auger drive.
- If traction drive lever (A) is also ENGAGED, you can release lever (B), auger drive will stay in the ENGAGED position. Release traction drive lever and both traction drive and auger drive will DISENGAGE.
- Traction drive lever (A) will work independently from the auger drive lever.

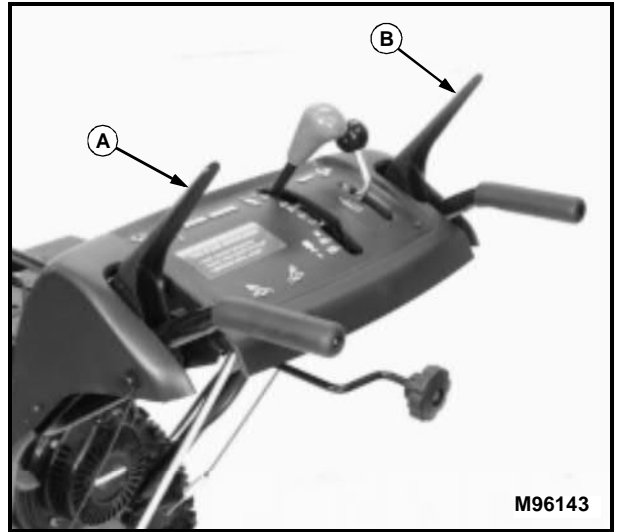

# OPERATING

## Using Speed Selector Lever

**IMPORTANT: DO NOT overload machine capacity by attempting to clear snow at too fast a rate.**

The speed selector lever (A) controls the units forward speed and reverse motion:

- **Moving the speed selector lever forward** increases forward travel. There are six forward speeds available: “1” is the slowest speed and “6” is the fastest speed.
- **Moving the speed selector lever rearward** increases reverse travel. There are two reverse speeds available: “R1” is the slowest speed and “R2” is the fastest speed.

### TO OPERATE SPEED SELECTOR LEVER:

- With engine running, position speed selector lever in the notch of the desired speed and ENGAGE the traction drive lever (B).
- DO NOT change forward speeds without declutching (releasing traction drive lever).
- DO NOT change motion from forward to reverse with traction drive lever ENGAGED.
- Release traction drive lever to STOP forward or reverse travel.

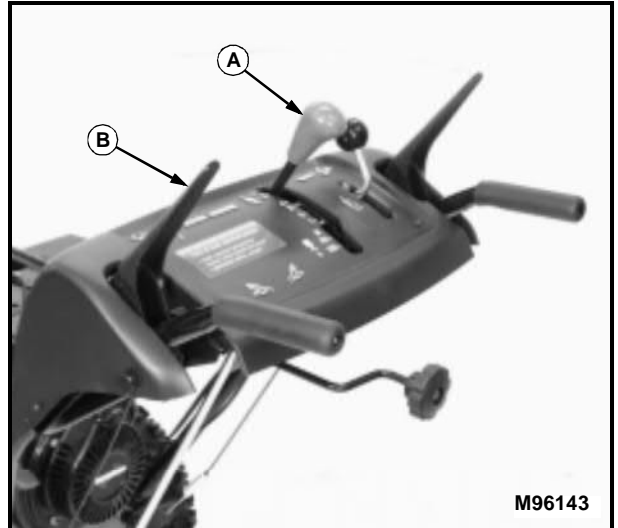

**Thank you very much  
for your reading.**

**Please click here and go  
back to the website.**

**Then, you can  
download the complete  
manual instantly.**

**No waiting.**