

**LT133, LT155,
and LT166
Lawn Tractors
(Serial No. 010001 –)**

**OPERATOR'S
MANUAL**

**John Deere
Worldwide Commercial and
Consumer Equipment Division
OMM135075 J7**

North American Version
Litho in U.S.A
English

INTRODUCTION

THANK YOU for purchasing a John Deere product.

Read this manual and your attachment manuals thoroughly. Failure to do so could result in personal injury or equipment damage.



 **WARNING:** The Engine Exhaust from this product contains chemicals known to the State of California to cause cancer, birth defects or other reproductive harm.

CALIFORNIA Proposition 65 Warning

This manual should be considered a permanent part of your machine and should remain with the machine when you sell it. Measurements in this manual are metric units and their U.S. customary equivalents. RIGHT-HAND and LEFT-HAND sides are determined by facing in the direction the machine will travel when going forward. When you see a broken line arrow (---) it indicates the part it is pointing to is hidden.

Record identification numbers below. Be sure to record all the numbers to help in tracing the machine if it is stolen. You also need to give these numbers to your dealer when you order parts.

Date of Purchase:

Dealer Name: _____ **Phone:** _____

Vehicle Serial Number:

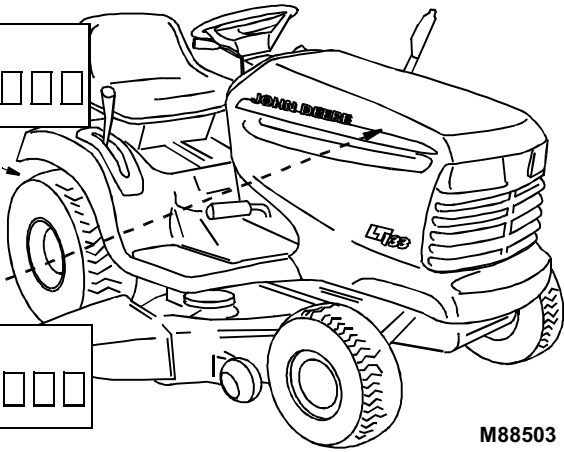

Engine Serial Number:

M88503

TABLE OF CONTENTS

	Page
Safety	1
Controls	4
Operating the Machine	6
Operating the Mower	25
Lawn Care	37
Replacement Parts	44
Service Machine Safely	46
Service Intervals	48
Service-Engine	50
Service-Transmission	61
Service-Steering and Brakes	62
Service-Mower	64
Service-Electrical	80
Service-Miscellaneous	89
Removing Mower	93
Installing Mower	96
Troubleshooting	99
Storing Vehicle	107

SAFETY SIGNS

Safety-Alert Symbol

Read and recognize safety information. Be alert to the potential for personal injury when you see this safety-alert symbol.

On your machine safety labels, the words DANGER, WARNING, and CAUTION are used with this safety-alert symbol. DANGER identifies the most serious hazards.

In this manual, the word CAUTION and this symbol call attention to safety messages.



Machine Safety Labels

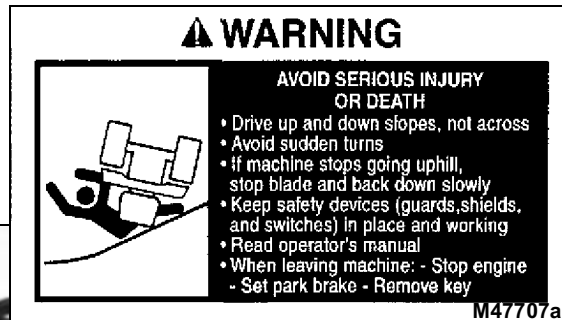

SAFETY SIGNS







⚠ WARNING

To avoid injury from loaded spring, read operator's manual before changing attachments.

On Left -Hand side of tractor frame M88494



⚠ DANGER			⚠ CAUTION	
 <p>SHIELD EYES EXPLOSIVE GASES CAN CAUSE BLINDNESS OR INJURY</p>	<p>NO</p> <ul style="list-style-type: none"> • SPARKS • FLAMES • SMOKING 	 <p>SULFURIC ACID CAN CAUSE BLINDNESS OR SEVERE BURNS</p>	 <p>FLUSH EYES IMMEDIATELY WITH WATER. GET MEDICAL HELP FAST.</p> <p>KEEP OUT OF REACH OF CHILDREN. DO NOT TIP. KEEP VENT CAPS TIGHT AND LEVEL.</p>	 <p>LEAD RECYCLE RETURN</p>
On Battery			M88490	

SAFETY SIGNS



Certification Label

This OPEI label on your mower indicates that this model has been certified by an independent laboratory for compliance with American National Standard B-71.1-1996, "Safety Specifications" for Power Lawn Mowers, Lawn and Garden Tractors, and Lawn Tractors.



CONTROLS

Console Controls



- A - Mower Blade Engagement Lever
- B - Key Switch
- C - Park Brake Lever
- D - Choke Knob (LT166 Only)
- E - Throttle Lever
- F - Mower Height Control
- G - Mower Lift Lever



CONTROLS

Foot/Platform Controls (LT133)

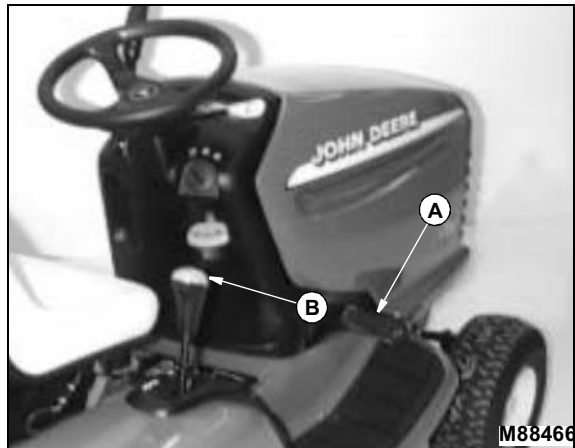

- A - Brake/Clutch Pedal
- B - Transmission Shift Lever

Foot Controls (LT155 and LT166)

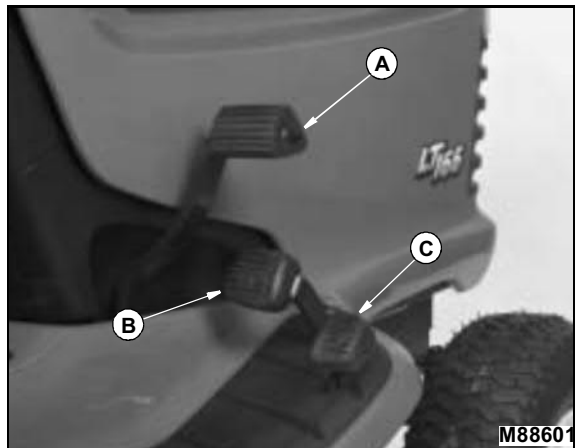

- A - Brake Pedal
- B - Forward Travel Pedal
- C - Reverse Travel Pedal

OPERATING THE MACHINE

SAFETY



Operate Safely

- Check brake action before you operate. Adjust or service brakes as necessary.
- Inspect machine before you operate. Be sure hardware is tight. Repair or replace damaged, badly worn, or missing parts. Be sure guards and shields are in good condition and fastened in place. Make any necessary adjustments before you operate.
- Clear work area of objects that might be thrown. Keep people and pets out of the work area. Stop machine if anyone enters the area.
- If you hit an object, stop the machine and inspect it. Make repairs before you operate. Keep machine and attachments properly maintained and in good working order.
- DO NOT leave machine unattended when it is running.
- Only operate during daylight or with good artificial light.
- Be careful of traffic when operating near or crossing roadways.
- Do not wear radio or music headphones while operating the machine. Safe operation requires your full attention.

Park Safely

- Stop machine on a level surface, not on a slope.
- Disengage mower blades.
- Lower attachments to the ground.
- Engage park brake.
- STOP engine.
- Remove key.
- Before you leave the operator's seat, wait for engine and all moving parts to STOP.

OPERATING THE MACHINE

Rotating Blades are Dangerous - Protect Children and Prevent Accidents

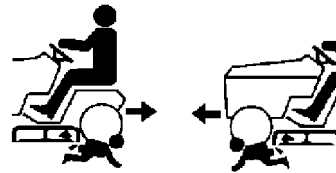

PROTECT CHILDREN:

- Never assume that children will remain where you last saw them. Children are attracted to mowing activity, stay alert to the presence of children.
- Keep children in the house when you are operating the machine.
- Turn machine off if a child enters the mowing area.
- Use extra care when you come to blind corners, shrubs, trees, or other objects that may block your vision.
- DO NOT let children or an untrained person operate the machine.
- DO NOT carry or let children ride on machine or any attachment. DO NOT tow children in a cart or trailer.

HELP PREVENT SERIOUS OR FATAL ACCIDENTS:

- Be alert at all times, drive forward carefully. People, especially children can move quickly into the mowing area before you know it.
- Back carefully. Disengage mower blades and look behind the machine carefully, especially for children, before you back up.
- DO NOT mow in reverse unless it is absolutely necessary.
- Disengage mower blades when you are not mowing.
- DO NOT operate machine if you are under the influence of drugs or alcohol.

**Thank you very much
for your reading.**

**Please click here and go
back to the website.**

**Then, you can
download the complete
manual instantly.**

No waiting.