

Edition: August 2003
 Revision: February 2004
 Publication No. SM4E-1F50U2

QUICK REFERENCE INDEX



©2004 NISSAN MOTOR CO., LTD.

A GENERAL INFORMATION	GI General Information
B ENGINE	EM Engine Mechanical
	LU Engine Lubrication System
	CO Engine Cooling System
	EC Engine Control System
	FL Fuel System
	EX Exhaust System
	ACC Accelerator Control System
	AT Automatic Transmission
C TRANSMISSION/ TRANSAXLE	
D DRIVELINE/AXLE	PR Propeller Shaft
	RFD Rear Final Drive
	FAX Front Axle
	RAX Rear Axle
E SUSPENSION	FSU Front Suspension
	RSU Rear Suspension
	WT Road Wheels & Tires
	SCS Suspension Control System
F BRAKES	BR Brake System
	PB Parking Brake System
	BRC Brake Control System
G STEERING	PS Power Steering System
	STC Steering Control System
H RESTRAINTS	SB Seat Belts
	SRS Supplemental Restraint System (SRS)
I BODY	BL Body, Lock & Security System
	GW Glasses, Window System & Mirrors
	RF Roof
	EI Exterior & Interior
	IP Instrument Panel
	SE Seat
J AIR CONDITIONER	ATC Automatic Air Conditioner
K ELECTRICAL	SC Starting & Charging System
	LT Lighting System
	DI Driver Information System
	WW Wiper, Washer & Horn
	LAN LAN System
	AV Audio, Visual, Navigation & Telephone System
	ACS Auto Cruise Control System
	PG Power Supply, Ground & Circuit Elements
L MAINTENANCE	MA Maintenance
M INDEX	IDX Alphabetical Index



All rights reserved. No part of this Service Manual may be reproduced or stored in a retrieval system, or transmitted in any form, or by any means, electronic, mechanical, recording or otherwise, without the prior written permission of Nissan Motor Company Ltd., Tokyo, Japan.

FOREWORD

This manual contains maintenance and repair procedure for the 2004 INFINITI Q45.

In order to assure your safety and the efficient functioning of the vehicle, this manual should be read thoroughly. It is especially important that the PRECAUTIONS in the GI section be completely understood before starting any repair task.

All information in this manual is based on the latest product information at the time of publication. The right is reserved to make changes in specifications and methods at any time without notice.

IMPORTANT SAFETY NOTICE

The proper performance of service is essential for both the safety of the technician and the efficient functioning of the vehicle.

The service methods in this Service Manual are described in such a manner that the service may be performed safely and accurately. Service varies with the procedures used, the skills of the technician and the tools and parts available. Accordingly, anyone using service procedures, tools or parts which are not specifically recommended by NISSAN must first be completely satisfied that neither personal safety nor the vehicle's safety will be jeopardized by the service method selected.



NISSAN MOTOR CO., LTD.

INCH TO METRIC CONVERSION TABLE

(Rounded-off for automotive use)

inches	mm	inches	mm
.100	2.54	.610	15.49
.110	2.79	.620	15.75
.120	3.05	.630	16.00
.130	3.30	.640	16.26
.140	3.56	.650	16.51
.150	3.81	.660	16.76
.160	4.06	.670	17.02
.170	4.32	.680	17.27
.180	4.57	.690	17.53
.190	4.83	.700	17.78
.200	5.08	.710	18.03
.210	5.33	.720	18.29
.220	5.59	.730	18.54
.230	5.84	.740	18.80
.240	6.10	.750	19.05
.250	6.35	.760	19.30
.260	6.60	.770	19.56
.270	6.86	.780	19.81
.280	7.11	.790	20.07
.290	7.37	.800	20.32
.300	7.62	.810	20.57
.310	7.87	.820	20.83
.320	8.13	.830	21.08
.330	8.38	.840	21.34
.340	8.64	.850	21.59
.350	8.89	.860	21.84
.360	9.14	.870	22.10
.370	9.40	.880	22.35
.380	9.65	.890	22.61
.390	9.91	.900	22.86
.400	10.16	.910	23.11
.410	10.41	.920	23.37
.420	10.67	.930	23.62
.430	10.92	.940	23.88
.440	11.18	.950	24.13
.450	11.43	.960	24.38
.460	11.68	.970	24.64
.470	11.94	.980	24.89
.480	12.19	.990	25.15
.490	12.45	1.000	25.40
.500	12.70	2.000	50.80
.510	12.95	3.000	76.20
.520	13.21	4.000	101.60
.530	13.46	5.000	127.00
.540	13.72	6.000	152.40
.550	13.97	7.000	177.80
.560	14.22	8.000	203.20
.570	14.48	9.000	228.60
.580	14.73	10.000	254.00
.590	14.99	20.000	508.00
.600	15.24		

METRIC TO INCH CONVERSION TABLE

(Rounded-off for automotive use)

mm	inches	mm	inches
1	.0394	51	2.008
2	.079	52	2.047
3	.118	53	2.087
4	.157	54	2.126
5	.197	55	2.165
6	.236	56	2.205
7	.276	57	2.244
8	.315	58	2.283
9	.354	59	2.323
10	.394	60	2.362
11	.433	61	2.402
12	.472	62	2.441
13	.512	63	2.480
14	.551	64	2.520
15	.591	65	2.559
16	.630	66	2.598
17	.669	67	2.638
18	.709	68	2.677
19	.748	69	2.717
20	.787	70	2.756
21	.827	71	2.795
22	.866	72	2.835
23	.906	73	2.874
24	.945	74	2.913
25	.984	75	2.953
26	1.024	76	2.992
27	1.063	77	3.031
28	1.102	78	3.071
29	1.142	79	3.110
30	1.181	80	3.150
31	1.220	81	3.189
32	1.260	82	3.228
33	1.299	83	3.268
34	1.339	84	3.307
35	1.378	85	3.346
36	1.417	86	3.386
37	1.457	87	3.425
38	1.496	88	3.465
39	1.535	89	3.504
40	1.575	90	3.543
41	1.614	91	3.583
42	1.654	92	3.622
43	1.693	93	3.661
44	1.732	94	3.701
45	1.772	95	3.740
46	1.811	96	3.780
47	1.850	97	3.819
48	1.890	98	3.858
49	1.929	99	3.898
50	1.969	100	3.937

QUICK REFERENCE CHART Q45
ENGINE TUNE-UP DATA (VK45DE)

PFP:00000

ELS0003W

Engine model	VK45DE	
Firing order	1-8-7-3-6-5-4-2	
Idle speed A/T (In "P" or "N" position) rpm	650±50	
Ignition timing (BTDC at idle speed)	12°±5°	
CO% at idle	0.7 - 9.9 % and engine runs smoothly	
Tensions of drive belts	Auto adjustment by auto tensioner	
Radiator cap relief pressure Standard kPa (kg/cm ² , psi)	78-98 (0.8-1.0 , 11-14)	
Cooling system leakage testing pressure kPa (kg/cm ² , psi)	157(1.6, 23)	
Compression pressure Standard kPa (kg/cm ² , psi)/rpm	1,320 (13.5, 191) /300	
Minimum	1,130 (11.5, 164)/300	
Spark plug Standard type	PLFR5A - 11	
Hot type	PLFR4A - 11	
Cold type	PLFR6A - 11	

FRONT WHEEL ALIGNMENT (Unladen*)

ELS0003X

Camber	Degree minute (Decimal degree)	Minimum	- 1° 30' (- 1.50°)
		Nominal	- 0° 45' (- 0.75°)
		Maximum	0° 00' (0.00°)
		Left and right difference	45' (0.75°) or less
Caster	Degree minute (Decimal degree)	Minimum	5° 25' (5.42°)
		Nominal	6° 10' (6.17°)
		Maximum	6° 55' (6.92°)
		Left and right difference	45' (0.75°) or less
Kingpin inclination	Degree minute (Decimal degree)	Minimum	13° 15' (13.25°)
		Nominal	14° 00' (14.00°)
		Maximum	14° 45' (14.75°)
Total toe-in Distance (A - B) mm (in)	Degree minute (Decimal degree)	Nominal	1 (0.04)
		Minimum	0' (0°)
		Nominal	3' (0.05°)
		Maximum	6' (0.10°)
Wheel turning angle (Full turn) Inside Degree minute (Decimal degree)	Degree minute (Decimal degree)	Minimum	39° 45' (39.75°)
		Nominal	42° 45' (42.75°)
		Maximum	43° 45' (43.75°)
		Nominal	33° 50' (33.83°)
Outside Degree minute (Decimal degree)	Degree minute (Decimal degree)	Minimum	39° 45' (39.75°)
		Nominal	33° 50' (33.83°)

* : Fuel radiator coolant and engine oil full. Spare tire, jack, hand tools and mats in designated positions.

REAR WHEEL ALIGNMENT (Unladen*)

ELS0003Y

Tire			17 inch	18 inch	
Camber Degree minute (Decimal degree)		Minimum	- 0° 55' (- 0.92°)	- 1° 05' (- 1.08°)	
		Nominal	- 0° 25' (- 0.42°)	- 0° 35' (- 0.58°)	
		Maximum	0° 05' (0.08°)	- 0° 05' (-0.08°)	
		Left and right difference	45'(0.75) or less		
Total toe-in	Distance (A-B)	mm (in)	Minimum	- 2.0 (- 0.079)	- 1.6 (- 0.063)
			Nominal	0.8 (0.031)	1.2 (0.047)
			Maximum	3.6 (0.142)	4.0 (0.157)
	Angle (left plus right)	Degree minute (Decimal degree)	Minimum	- 5' (0.08°)	- 4' (0.07°)
			Nominal	2' (0.03°)	3' (0.05°)
			Maximum	9' (0.15°)	10' (0.17°)

* : Fuel, radiator coolant and oil full.
Spare tire, jack, hand tools and mats in designated positions.

BRAKE

ELS0003Z

Unit : mm (in)

Front brake		
Pad wear limit		2.0 (0.079)
Rotor repair limit		26.0 (1.024)
Rear brake		
Pad wear limit		2.0 (0.079)
Rotor repair limit		14.0 (0.551)
Pedal free height		192.4 - 202.4 (7.57 - 7.97)
Pedal depressed height*		More than 90 (3.54)

* : Under force of 490 N(50 kg, 110 lb) with engine running.

REFILL CAPACITIES

ELS00040

UNIT		Liter	US measure
Fuel tank		80	21 - 1/8 gal
Coolant (With reservoir tank)		9.8	10 - 3/8 qt
Engine*	Drain and refill		
	With oil filter change	5.6	5 - 7/8 qt
	Without oil filter change	5.0	5 - 1/4 qt
	Dry engine (overhall)	6.7	7 - 1/8 qt
Transmission	A/T	10.3	10 - 7/8 qt
Differential carrier		1.4	3 pt
Power steering system		1.0	1 - 1/8 qt
Air conditioning system	Compressor oil	0.18	6.0 fl oz
	Refrigerant	0.60 kg	1.32 lb

* : For further details, see "Changing Engine Oil" in MA section.

SECTION **GI**

GENERAL INFORMATION

CONTENTS

PRECAUTIONS	3	DESCRIPTION	16
Description	3	Abbreviations	22
Precautions for Supplemental Restraint System (SRS) "AIR BAG" and "SEAT BELT PRE-TENSIONER"	3	SERVICE INFORMATION FOR ELECTRICAL INCIDENT	23
Precautions for NVIS/IVIS (NISSAN/INFINITI VEHICLE IMMOBILIZER SYSTEM - NATS) (If Equipped)	3	How to Check Terminal	23
General Precautions	4	CONNECTOR AND TERMINAL PIN KIT	23
Precautions for Three Way Catalyst	5	HOW TO PROBE CONNECTORS	23
Precautions for Fuel (Unleaded Premium Gasoline Required)	5	How to Perform Efficient Diagnosis for an Electrical Incident	26
Precautions for Multiport Fuel Injection System or Engine Control System	6	WORK FLOW	26
Precautions for Hoses	6	INCIDENT SIMULATION TESTS	26
HOSE REMOVAL AND INSTALLATION	6	CIRCUIT INSPECTION	29
HOSE CLAMPING	6	Control Units and Electrical Parts	34
Precautions for Engine Oils	7	PRECAUTIONS	34
HEALTH PROTECTION PRECAUTIONS	7	CONSULT-II CHECKING SYSTEM	36
ENVIRONMENTAL PROTECTION PRECAUTIONS	7	Description	36
Precautions for Air Conditioning	7	Function and System Application	36
HOW TO USE THIS MANUAL	8	Nickel Metal Hydride Battery Replacement	36
Description	8	Checking Equipment	37
Terms	8	CONSULT-II Start Procedure	37
Units	8	CONSULT-II Data Link Connector (DLC) Circuit ...	38
Contents	8	INSPECTION PROCEDURE	39
Components	9	LIFTING POINT	40
SYMBOLS	9	Special Service Tools	40
How to Follow Trouble Diagnoses	10	Garage Jack and Safety Stand	40
DESCRIPTION	10	2-pole Lift	41
HOW TO FOLLOW TEST GROUPS IN TROUBLE DIAGNOSES	10	Board-on Lift	42
HARNES WIRE COLOR AND CONNECTOR NUMBER INDICATION	11	TOW TRUCK TOWING	43
KEY TO SYMBOLS SIGNIFYING MEASUREMENTS OR PROCEDURES	12	Tow Truck Towing	43
How to Read Wiring Diagrams	14	Vehicle Recovery (Freeing a Stuck Vehicle)	44
CONNECTOR SYMBOLS	14	TIGHTENING TORQUE OF STANDARD BOLTS ...	45
SAMPLE/WIRING DIAGRAM - EXAMPL -	15	Tightening Torque Table	45
		RECOMMENDED CHEMICAL PRODUCTS AND SEALANTS	46
		Recommended Chemical Products and Sealants..	46
		IDENTIFICATION INFORMATION	47
		Model Variation	47
		IDENTIFICATION NUMBER	47
		IDENTIFICATION PLATE	48
		ENGINE SERIAL NUMBER	48

AUTOMATIC TRANSMISSION NUMBER	48	TERMINOLOGY	50
Dimensions	49	SAE J1930 Terminology List	50
Wheels & Tires	49		

PRECAUTIONS

PPF:00001

Description

EAS0008Z

Observe the following precautions to ensure safe and proper servicing. These precautions are not described in each individual section.

Precautions for Supplemental Restraint System (SRS) “AIR BAG” and “SEAT BELT PRE-TENSIONER”

EAS0015J

The Supplemental Restraint System such as “AIR BAG” and “SEAT BELT PRE-TENSIONER”, used along with a front seat belt, helps to reduce the risk or severity of injury to the driver and front passenger for certain types of collision. This system includes seat belt switch inputs and dual stage front air bag modules. The SRS system uses the seat belt switches to determine the front air bag deployment, and may only deploy one front air bag, depending on the severity of a collision and whether the front occupants are belted or unbelted. Information necessary to service the system safely is included in the SRS and SB section of this Service Manual.

WARNING:

- To avoid rendering the SRS inoperative, which could increase the risk of personal injury or death in the event of a collision which would result in air bag inflation, all maintenance must be performed by an authorized NISSAN/INFINITI dealer.
- Improper maintenance, including incorrect removal and installation of the SRS, can lead to personal injury caused by unintentional activation of the system. For removal of Spiral Cable and Air Bag Module, see the SRS section.
- Do not use electrical test equipment on any circuit related to the SRS unless instructed to in this Service Manual. SRS wiring harnesses can be identified by yellow and/or orange harnesses or harness connectors.

Precautions for NVIS/IVIS (NISSAN/INFINITI VEHICLE IMMOBILIZER SYSTEM - NATS) (If Equipped)

EAS000DZ

NVIS/IVIS (NATS) will immobilize the engine if someone tries to start it without the registered key of NVIS/IVIS (NATS).

Both of the originally supplied ignition key IDs have been NVIS/IVIS (NATS) registered.

The security indicator is located on the instrument panel. The indicator blinks when the immobilizer system is functioning.

Therefore, NVIS/IVIS (NATS) warns outsiders that the vehicle is equipped with the anti-theft system.

- When NVIS/IVIS (NATS) detects trouble, the security indicator lamp lights up while ignition switch is in "ON" position.
This lighting up indicates that the anti-theft is not functioning, so prompt service is required.
- When servicing NVIS/IVIS (NATS) (trouble diagnoses, system initialization and additional registration of other NVIS/IVIS (NATS) ignition key IDs), CONSULT-II hardware and CONSULT-II NVIS/IVIS (NATS) software is necessary.
Regarding the procedures of NVIS/IVIS (NATS) initialization and NVIS/IVIS (NATS) ignition key ID registration, refer to CONSULT-II operation manual, NVIS/IVIS (NATS).

Therefore, CONSULT-II NVIS/IVIS (NATS) software (program card and operation manual) must be kept strictly confidential to maintain the integrity of the anti-theft function.

- When servicing NVIS/IVIS (NATS) (trouble diagnoses, system initialization and additional registration of other NVIS/IVIS (NATS) ignition key IDs), it may be necessary to re-register original key identification. Therefore, be sure to receive all keys from vehicle owner. A maximum of four or five key IDs can be registered into NVIS/IVIS (NATS).
- When failing to start the engine first time using the key of NVIS/IVIS (NATS), start as follows.
 1. Leave the ignition key in "ON" position for approximately 5 seconds.
 2. Turn ignition key to "OFF" or "LOCK" position and wait approximately 5 seconds.
 3. Repeat step 1 and 2 again.
 4. Restart the engine while keeping the key separate from any others on key-chain.

PRECAUTIONS

EAS000E0

General Precautions

- Do not operate the engine for an extended period of time without proper exhaust ventilation.
Keep the work area well ventilated and free of any inflammable materials. Special care should be taken when handling any inflammable or poisonous materials, such as gasoline, refrigerant gas, etc. When working in a pit or other enclosed area, be sure to properly ventilate the area before working with hazardous materials.
Do not smoke while working on the vehicle.

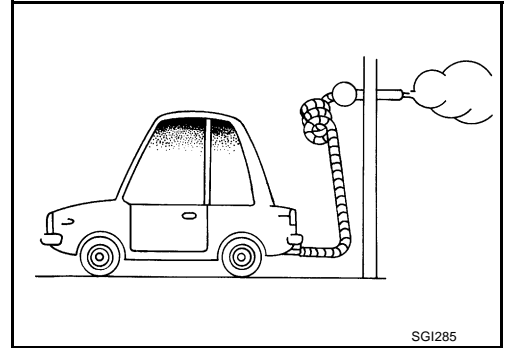

- Before jacking up the vehicle, apply wheel chocks or other tire blocks to the wheels to prevent the vehicle from moving. After jacking up the vehicle, support the vehicle weight with safety stands at the points designated for proper lifting before working on the vehicle.
These operations should be done on a level surface.
- When removing a heavy component such as the engine or transaxle/transmission, be careful not to lose your balance and drop them. Also, do not allow them to strike adjacent parts, especially the brake tubes and master cylinder.

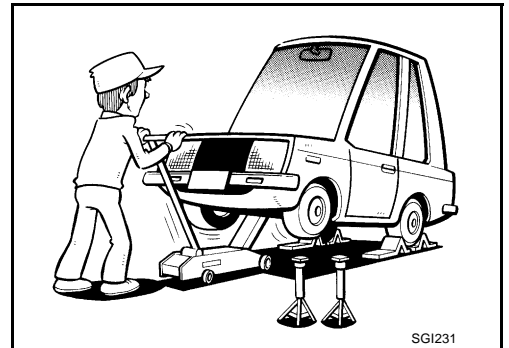

- Before starting repairs which do not require battery power:
Turn off ignition switch.
Disconnect the negative battery terminal.
- If the battery terminals are disconnected, recorded memory of radio and each control unit is erased.

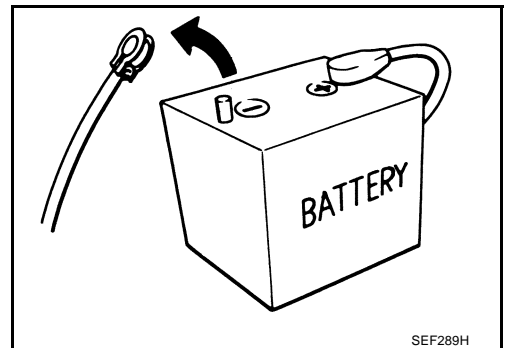

- To prevent serious burns:
Avoid contact with hot metal parts.
Do not remove the radiator cap when the engine is hot.
- Dispose of drained oil or the solvent used for cleaning parts in an appropriate manner.
- Do not attempt to top off the fuel tank after the fuel pump nozzle shuts off automatically.
Continued refueling may cause fuel overflow, resulting in fuel spray and possibly a fire.
- Clean all disassembled parts in the designated liquid or solvent prior to inspection or assembly.
- Replace oil seals, gaskets, packings, O-rings, locking washers, cotter pins, self-locking nuts, etc. with new ones.
- Replace inner and outer races of tapered roller bearings and needle bearings as a set.
- Arrange the disassembled parts in accordance with their assembled locations and sequence.
- Do not touch the terminals of electrical components which use microcomputers (such as ECM).
Static electricity may damage internal electronic components.
- After disconnecting vacuum or air hoses, attach a tag to indicate the proper connection.
- Use only the fluids and lubricants specified in this manual.

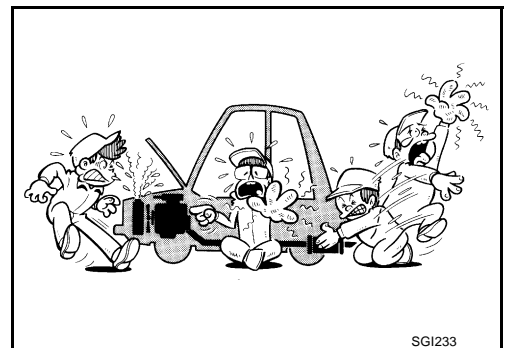

PRECAUTIONS

- Use approved bonding agent, sealants or their equivalents when required.
- Use hand tools, power tools (disassembly only) and recommended special tools where specified for safe and efficient service repairs.
- When repairing the fuel, oil, water, vacuum or exhaust systems, check all affected lines for leaks.

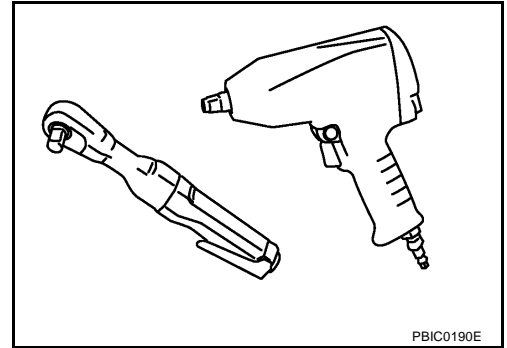

- Before servicing the vehicle:
Protect fenders, upholstery and carpeting with appropriate covers.
Take caution that keys, buckles or buttons do not scratch paint.

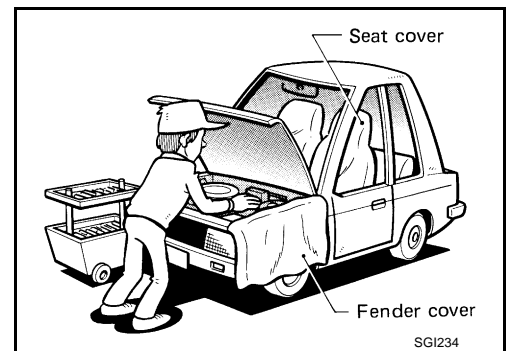

WARNING:

To prevent ECM from storing the diagnostic trouble codes, do not carelessly disconnect the harness connectors which are related to the engine control system and TCM (transmission control module) system. The connectors should be disconnected only when working according to the WORK FLOW of TROUBLE DIAGNOSES in EC and AT sections.

Precautions for Three Way Catalyst

EAS00085

If a large amount of unburned fuel flows into the catalyst, the catalyst temperature will be excessively high. To prevent this, follow the instructions.

- Use unleaded gasoline only. Leaded gasoline will seriously damage the three way catalyst.
- When checking for ignition spark or measuring engine compression, make tests quickly and only when necessary.
- Do not run engine when the fuel tank level is low, otherwise the engine may misfire, causing damage to the catalyst.

Do not place the vehicle on flammable material. Keep flammable material off the exhaust pipe and the three way catalyst.

Precautions for Fuel (Unleaded Premium Gasoline Required)

EAS0009Y

Use unleaded premium gasoline with an octane rating of at least 91 AKI (Anti-Knock Index) number (Research octane number 96).

If unleaded premium gasoline is not available, unleaded regular gasoline with an octane rating of at least 87 AKI number (Research octane number 91) can be used, but only under the following precautions:

- have the fuel tank filled only partially with unleaded regular gasoline, and fill up with unleaded premium gasoline as soon as possible.
- avoid full throttle driving and abrupt acceleration.

However, for maximum vehicle performance, the use of unleaded premium gasoline is recommended.

CAUTION:

Do not use leaded gasoline. Using leaded gasoline will damage the three way catalyst. Using a fuel other than that specified could adversely affect the emission control devices and systems, and could also affect the warranty coverage validity.

PRECAUTIONS

Precautions for Multiport Fuel Injection System or Engine Control System

EAS00087

- Before connecting or disconnecting any harness connector for the multiport fuel injection system or ECM:
Turn ignition switch to "OFF" position.
Disconnect negative battery terminal.
Otherwise, there may be damage to ECM.
- Before disconnecting pressurized fuel line from fuel pump to injectors, be sure to release fuel pressure.
- Be careful not to jar components such as ECM and mass air flow sensor.



Precautions for Hoses

HOSE REMOVAL AND INSTALLATION

EAS000E3

- To prevent damage to rubber hose, do not pry off rubber hose with tapered tool or screwdriver.

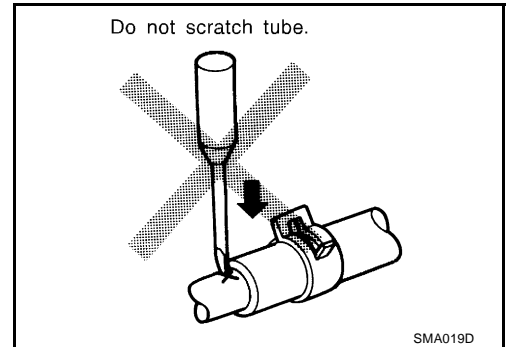

- To reinstall the rubber hose securely, make sure that hose insertion length and orientation is correct. (If tube is equipped with hose stopper, insert rubber hose into tube until it butts up against hose stopper.)

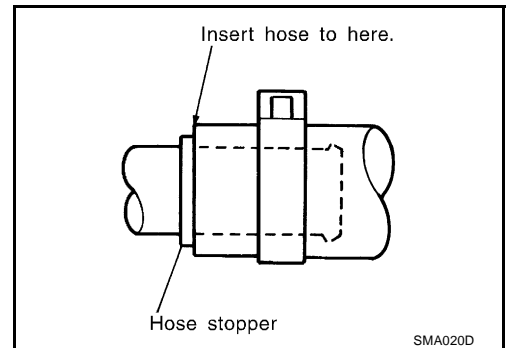

HOSE CLAMPING

- If old rubber hose is re-used, install hose clamp in its original position (at the indentation where the old clamp was). If there is a trace of tube bulging left on the old rubber hose, align rubber hose at that position.
- Discard old clamps; replace with new ones.

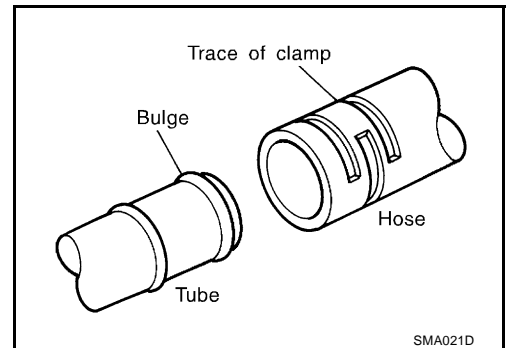

PRECAUTIONS

- After installing plate clamps, apply force to them in the direction of the arrow, tightening rubber hose equally all around.

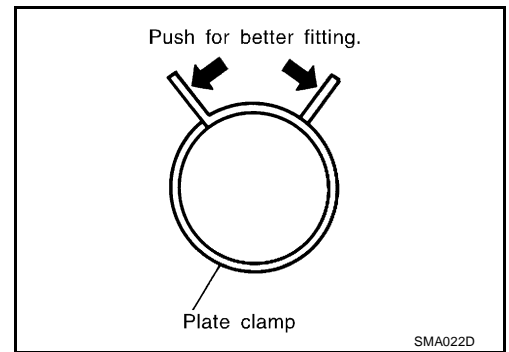

GI

B

C

D

EAS00088

Precautions for Engine Oils

Prolonged and repeated contact with used engine oil may cause skin cancer. Try to avoid direct skin contact with used oil.

If skin contact is made, wash thoroughly with soap or hand cleaner as soon as possible.

HEALTH PROTECTION PRECAUTIONS

- Avoid prolonged and repeated contact with oils, particularly used engine oils.
- Wear protective clothing, including impervious gloves where practicable.
- Do not put oily rags in pockets.
- Avoid contaminating clothes, particularly underpants, with oil.
- Heavily soiled clothing and oil-impregnated footwear should not be worn. Overalls must be cleaned regularly.
- First aid treatment should be obtained immediately for open cuts and wounds.
- Use barrier creams, applying them before each work period, to help the removal of oil from the skin.
- Wash with soap and water to ensure all oil is removed (skin cleansers and nail brushes will help). Preparations containing lanolin replace the natural skin oils which have been removed.
- Do not use gasoline, kerosene, diesel fuel, gas oil, thinners or solvents for cleaning skin.
- If skin disorders develop, obtain medical advice without delay.
- Where practical, degrease components prior to handling.
- Where there is a risk of eye contact, eye protection should be worn, for example, chemical goggles or face shields; in addition an eye wash facility should be provided.

E

F

G

H

I

J

K

ENVIRONMENTAL PROTECTION PRECAUTIONS

Dispose of used oil and used oil filters through authorized waste disposal contractors to licensed waste disposal sites, or to the waste oil reclamation trade. If in doubt, contact the local authority for advice on disposal facilities.

It is illegal to pour used oil on to the ground, down sewers or drains, or into water sources.

The regulations concerning pollution vary between regions.

L

M

Precautions for Air Conditioning

EAS0002W

Use an approved refrigerant recovery unit any time the air conditioning system must be discharged. Refer to ATC section "HFC-134a (R-134a) Service Procedure", "REFRIGERANT LINES" for specific instructions.

HOW TO USE THIS MANUAL

HOW TO USE THIS MANUAL

PFP:00008

Description

EAS0008A

This volume explains "Removal, Disassembly, Installation, Inspection and Adjustment" and "Trouble Diagnoses".

Terms

EAS0008B

- The captions **WARNING** and **CAUTION** warn you of steps that must be followed to prevent personal injury and/or damage to some part of the vehicle.
WARNING indicates the possibility of personal injury if instructions are not followed.
CAUTION indicates the possibility of component damage if instructions are not followed.
BOLD TYPED STATEMENTS except **WARNING** and **CAUTION** give you helpful information.
Standard value:Tolerance at inspection and adjustment.
Limit value:The maximum or minimum limit value that should not be exceeded at inspection and adjustment.

Units

EAS00158

- The **UNITS** given in this manual are primarily expressed as the SI UNIT (International System of Unit), and alternatively expressed in the metric system and in the yard/pound system.
Also with regard to tightening torque of bolts and nuts, there are descriptions both about range and about the standard tightening torque.

"Example"

Range

Outer Socket Lock Nut : 59 - 78 N-m (6.0 - 8.0 kg-m, 43 - 58 ft-lb)

Standard

Drive Shaft Installation Bolt : 44.3 N-m (4.5 kg-m, 33 ft-lb)

Contents

EAS0008D

- **ALPHABETICAL INDEX** is provided at the end of this manual so that you can rapidly find the item and page you are searching for.
- **A QUICK REFERENCE INDEX**, a black tab (e.g. **BR**) is provided on the first page. You can quickly find the first page of each section by matching it to the section's black tab.
- **THE CONTENTS** are listed on the first page of each section.
- **THE TITLE** is indicated on the upper portion of each page and shows the part or system.
- **THE PAGE NUMBER** of each section consists of two or three letters which designate the particular section and a number (e.g. "BR-5").
- **THE SMALL ILLUSTRATIONS** show the important steps such as inspection, use of special tools, knacks of work and hidden or tricky steps which are not shown in the previous large illustrations.
Assembly, inspection and adjustment procedures for the complicated units such as the automatic transaxle or transmission, etc. are presented in a step-by-step format where necessary.

HOW TO USE THIS MANUAL

EAS00159

Components

- **THE LARGE ILLUSTRATIONS** are exploded views (See the following) and contain tightening torques, lubrication points, section number of the **PARTS CATALOG** (e.g. SEC. 440) and other information necessary to perform repairs.

The illustrations should be used in reference to service matters only. When ordering parts, refer to the appropriate **PARTS CATALOG**.

Components shown in an illustration may be identified by a circled number. When this style of illustration is used, the text description of the components will follow the illustration.

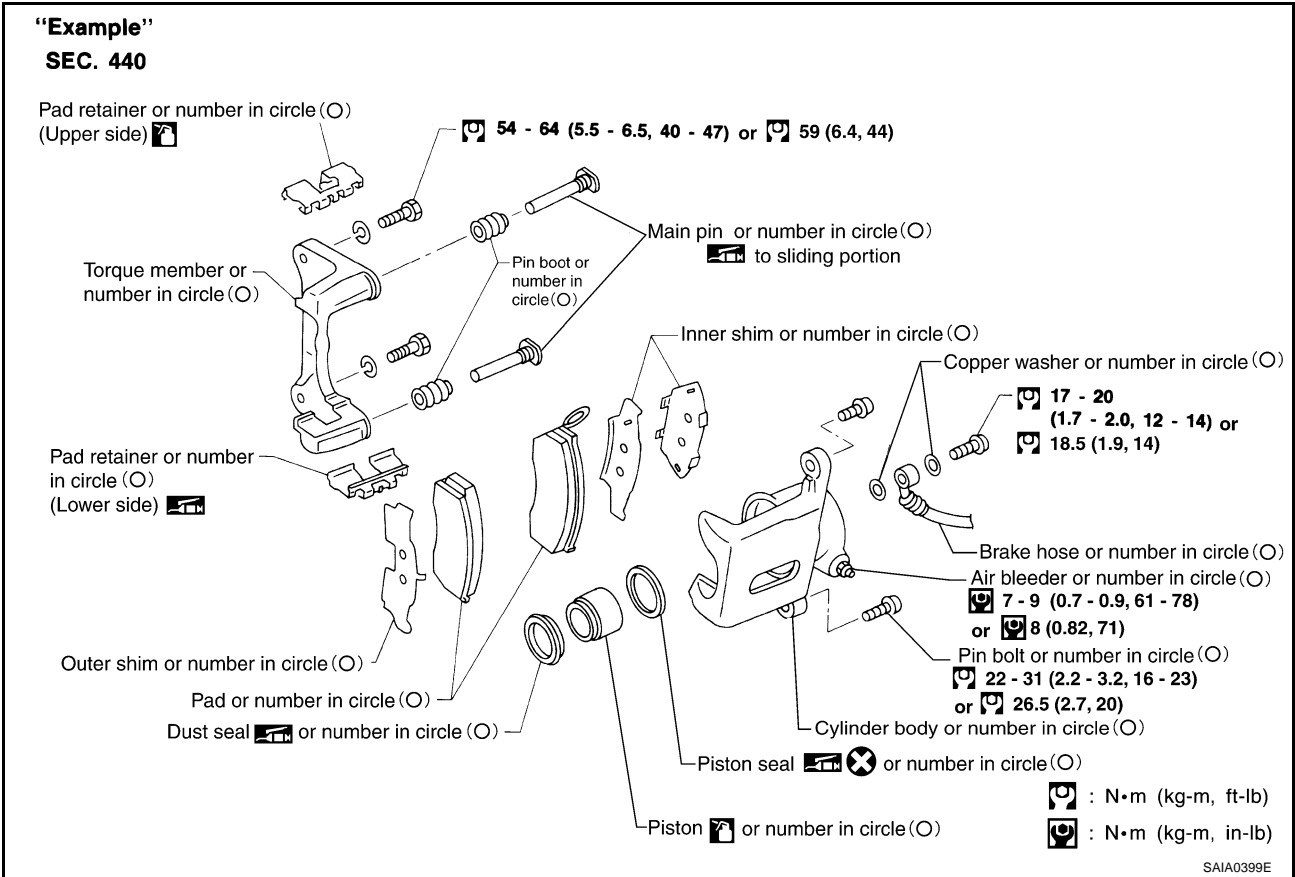

SYMBOLS

SYMBOL	DESCRIPTION
	Tightening torque
	The tightening torque specifications of bolts and nuts may be presented as either a range or a standard tightening torque.
	Should be lubricated with grease. Unless otherwise indicated, use recommended multi-purpose grease.
	Should be lubricated with oil.
	Sealing point
	Checking point
	Always replace after every disassembly.
	Apply petroleum jelly.
P	
	Apply ATF.
★	Select with proper thickness.
☆	Adjustment is required.

HOW TO USE THIS MANUAL

EAS0007R

How to Follow Trouble Diagnoses

DESCRIPTION

NOTICE:

Trouble diagnoses indicate work procedures required to diagnose problems effectively. Observe the following instructions before diagnosing.

1. **Before performing trouble diagnoses, read the “Preliminary Check”, the “Symptom Chart” or the “Work Flow”.**
2. **After repairs, re-check that the problem has been completely eliminated.**
3. **Refer to Component Parts and Harness Connector Location for the Systems described in each section for identification/location of components and harness connectors.**
4. **Refer to the Circuit Diagram for quick pinpoint check.**
If you need to check circuit continuity between harness connectors in more detail, such as when a sub-harness is used, refer to Wiring Diagram in each individual section and Harness Layout in PG section for identification of harness connectors.
5. **When checking circuit continuity, ignition switch should be OFF.**
6. **Before checking voltage at connectors, check battery voltage.**
7. **After accomplishing the Diagnostic Procedures and Electrical Components Inspection, make sure that all harness connectors are reconnected as they were.**

HOW TO FOLLOW TEST GROUPS IN TROUBLE DIAGNOSES

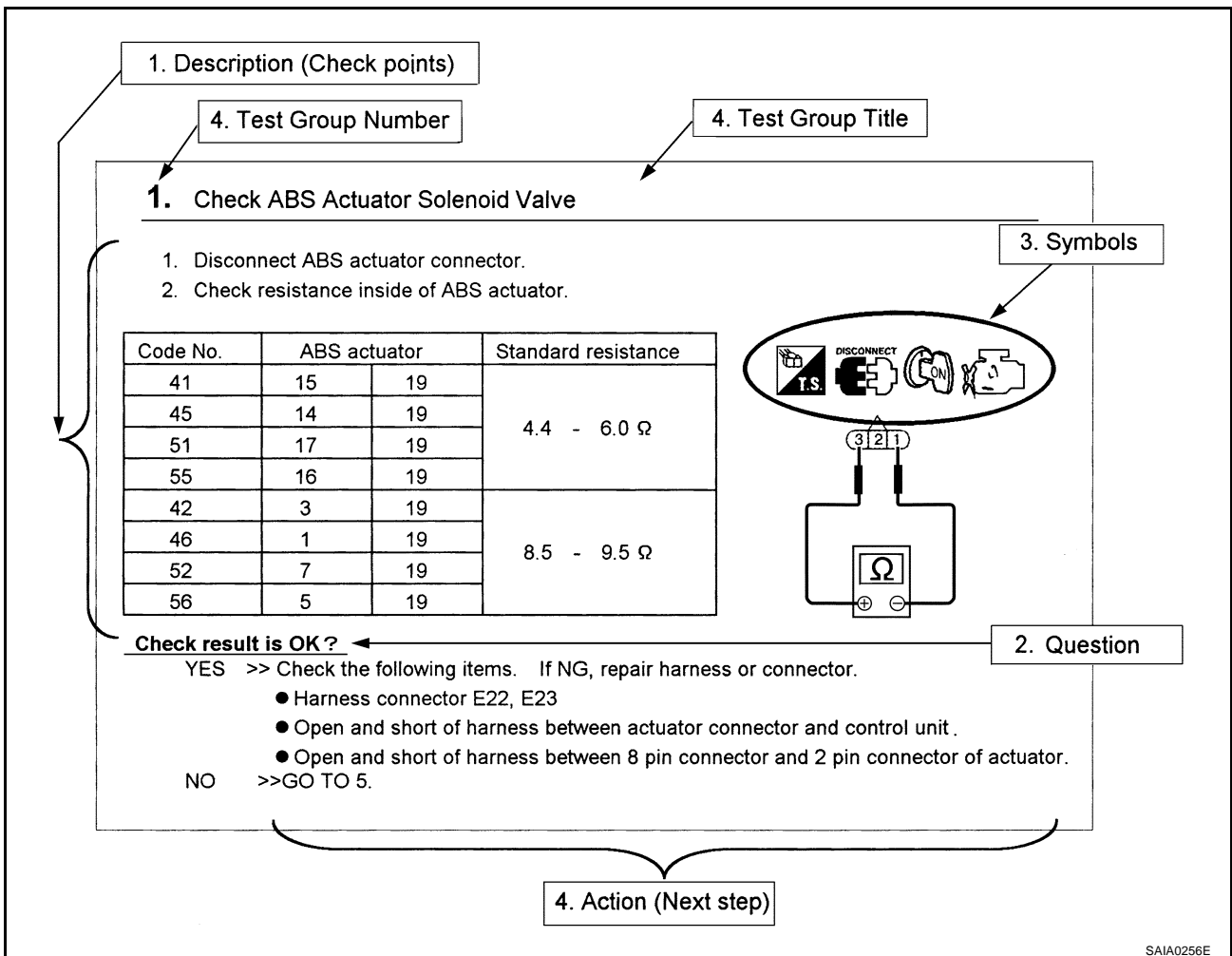

1. **Work and diagnostic procedure**
Start to diagnose a problem using procedures indicated in enclosed test groups.
2. **Questions and required results**
Questions and required results are indicated in bold type in test group.
The meaning of are as follows:

HOW TO USE THIS MANUAL

a. **Battery voltage** → 11 - 14V or approximately 12V

b. **Voltage** : Approximately 0V → Less than 1V

3. Symbol used in illustration

Symbols included in illustrations refer to measurements or procedures. Before diagnosing a problem, familiarize yourself with each symbol. Refer to "Connector Symbols" in GI Section and "KEY TO SYMBOLS SIGNIFYING MEASUREMENTS OR PROCEDURES" below.

4. Action items

Next action for each test group is indicated based on result of each question. Test group number is shown in the left upper portion of each test group.

HARNESS WIRE COLOR AND CONNECTOR NUMBER INDICATION

There are two types of harness wire color and connector number indication.

TYPE 1: Harness Wire Color and Connector Number are Shown in Illustration

- Letter designations next to test meter probe indicate harness wire color.
- Connector numbers in a single circle (e.g. M33) indicate harness connectors.
- Connector numbers in a double circle (e.g. F211) indicate component connectors.

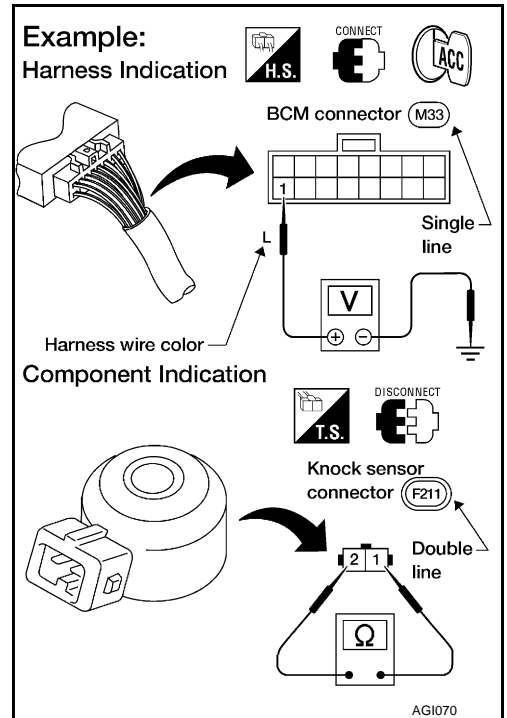

HOW TO USE THIS MANUAL

TYPE 2: Harness Wire Color and Connector Number are Shown in Text

Example 1:

2 CHECK INTAKE SENSOR CIRCUIT BETWEEN INTAKE SENSOR AND AUTO AMP. (LCU)

1. Disconnect auto amp. (LCU) harness connector.
2. Check circuit continuity between intake sensor harness connector M59 terminal No. 2 (GW) and auto amp. (LCU) harness connector M56 terminal No. 11 (GW).

OK or NG

Example 2:

DISCONNECT
H.S.
Combination meter connector

DISCONNECT
H.S.
Combination meter connector

POWER SUPPLY AND GROUND CIRCUIT CHECK

Power Supply Circuit Check

-NCEL00-16807
NCEL00-16807/01

Terminals		Ignition switch position		
(+)	(-)	OFF	ACC	ON
Connector	Terminal (Wire color)			
M40	37 (Y)	Ground	Battery voltage	Battery voltage
M41	1 (Y)	Ground	0V	0V

If NG, check the following.

- 7.5A fuse No. 5, located in fuse block (J/B)
- 10A fuse No. 11, located in fuse block (J/B)
- Harness for open or short between fuse and combination meter



















Connector number Wire color

SGI144A

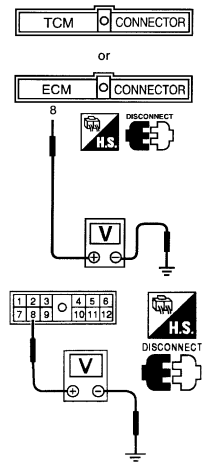
KEY TO SYMBOLS SIGNIFYING MEASUREMENTS OR PROCEDURES

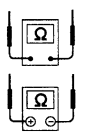
Symbol	Symbol explanation	Symbol	Symbol explanation
	Check after disconnecting the connector to be measured.		Procedure with Generic Scan Tool (GST, OBD-II scan tool)
	Check after connecting the connector to be measured.		Procedure without CONSULT, CONSULT-II or GST
	Insert key into ignition switch.		A/C switch is "OFF".
	Remove key from ignition switch.		A/C switch is "ON".
	Turn ignition switch to "OFF" position.		REC switch is "ON".
	Turn ignition switch to "ON" position.		REC switch is "OFF".
	Turn ignition switch to "START" position.		Fan switch is "ON". (At any position except for "OFF" position)
	Turn ignition switch from "OFF" to "ACC" position.		Fan switch is "OFF".
	Turn ignition switch from "ACC" to "OFF" position.		Apply positive voltage from battery with fuse directly to components.

HOW TO USE THIS MANUAL

Symbol	Symbol explanation	Symbol	Symbol explanation
	Turn ignition switch from "OFF" to "ON" position.		Drive vehicle.
	Turn ignition switch from "ON" to "OFF" position.		Disconnect battery negative cable.
	Do not start engine, or check with engine stopped.		Depress brake pedal.
	Start engine, or check with engine running.		Release brake pedal.
	Apply parking brake.		Depress accelerator pedal.
	Release parking brake.		Release accelerator pedal.
	Check after engine is warmed up sufficiently.	 <p>TCM CONNECTOR</p> <p>or</p> <p>ECM CONNECTOR</p> <p>DISCONNECT H.S.</p> <p>DISCONNECT H.S.</p>	Pin terminal check for SMJ type ECM and TCM connectors. For details regarding the terminal arrangement, refer to the "ELECTRICAL UNITS" electrical reference page at the end of the manual.
	Voltage should be measured with a voltmeter.		
	Circuit resistance should be measured with an ohmmeter.		
	Current should be measured with an ammeter.		
	Pulse signal should be checked with an oscilloscope.		
	Procedure with CONSULT-II		
	Procedure without CONSULT-II		

GI
B
C
D
E
F
G
H
I
J
K
L
M

HOW TO USE THIS MANUAL

EAS00076

How to Read Wiring Diagrams CONNECTOR SYMBOLS

Most of connector symbols in wiring diagrams are shown from the terminal side.

- Connector symbols shown from the terminal side are enclosed by a single line and followed by the direction mark.
- Connector symbols shown from the harness side are enclosed by a double line and followed by the direction mark.
- Certain systems and components, especially those related to OBD, may use a new style slide-locking type harness connector. For description and how to disconnect, refer to PG section, "Description", "HARNESS CONNECTOR".

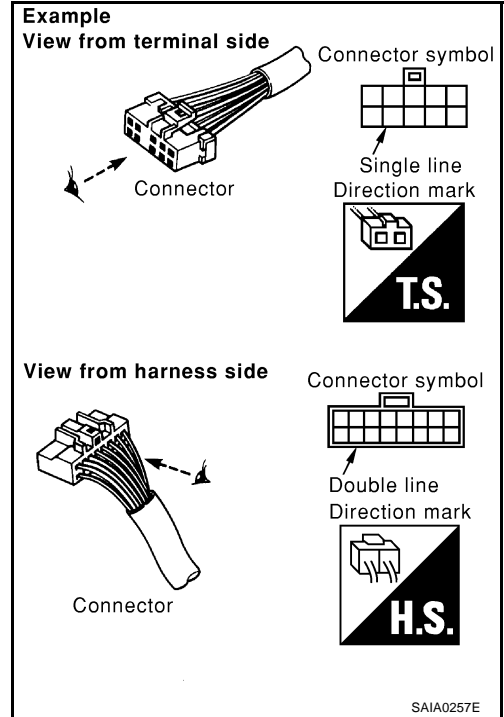

- Male and female terminals
Connector guides for male terminals are shown in black and female terminals in white in wiring diagrams.

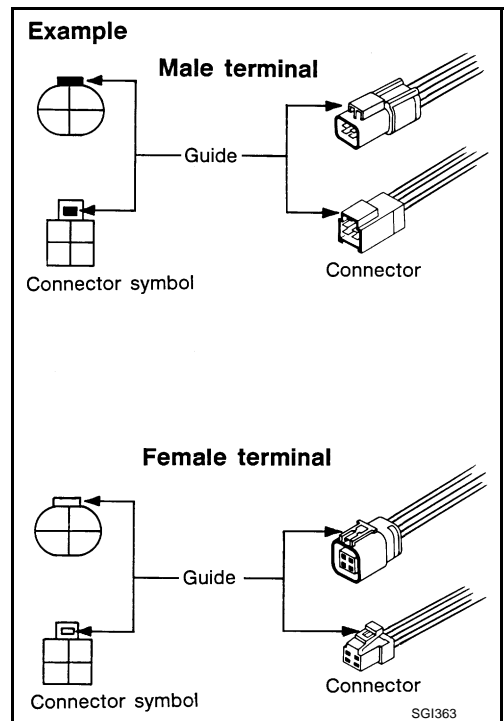

**Thank you very much
for your reading.**

**Please click here and go
back to the website.**

**Then, you can
download the complete
manual instantly.**

No waiting.