

JOHN DEERE
WORLDWIDE COMMERCIAL & CONSUMER
EQUIPMENT DIVISION

21-Inch Walk-Behind Rotary Mower
JS63E

OMGC00550 A1

OPERATOR'S MANUAL



 **WARNING:** The Engine Exhaust from this product contains chemicals known to the State of California to cause cancer, birth defects or other reproductive harm.

California Proposition 65 Warning

North American Version
Litho in U.S.A.

INTRODUCTION

Thank You for Purchasing a John Deere Product

We appreciate having you as a customer and wish you many years of safe and satisfied use of your machine.

Using Your Operator's Manual

This manual is an important part of your machine and should remain with the machine when you sell it.

Reading your operator's manual will help you and others avoid personal injury or damage to the machine. Information given in this manual will provide the operator with the safest and most effective use of the machine. Knowing how to operate this machine safely and correctly will allow you to train others who may operate this machine.

If you have an attachment, use the safety and operating information in the attachment operator's manual along with the machine operator's manual to operate the attachment safely and correctly.

This manual and safety signs on your machine may also be available in other languages (see your John Deere dealer to order).

Sections in your operator's manual are placed in a specific order to help you understand all the safety messages and learn the controls so you can operate this machine safely. You can also use this manual to answer any specific operating or servicing questions. A convenient index located at the end of this book will help you to find needed information quickly.

The machine shown in this manual may differ slightly from your machine, but will be similar enough to help you understand our instructions.

RIGHT-HAND and LEFT-HAND sides are determined by facing in the direction the machine will travel when going forward. When you see a broken line arrow (----->), the item referred to is hidden from view.

Before delivering this machine, your dealer performed a predelivery inspection to ensure best performance.

Special Messages

Your manual contains special messages to bring attention to potential safety concerns, machine damage as well as helpful operating and servicing information. Please read all the information carefully to avoid injury and machine damage.



CAUTION: Avoid injury! This symbol and text highlight potential hazards or death to the operator or bystanders that may occur if the hazards or procedures are ignored.

IMPORTANT: Avoid damage! This text is used to tell the operator of actions or conditions that might result in damage to the machine.

NOTE: General information is given throughout the manual that may help the operator in the operation or service of the machine.

CALIFORNIA Proposition 65 Warning



Warning: The Engine Exhaust from this product contains chemicals known to the State of California to cause cancer, birth defects or other reproductive harm.

TABLE OF CONTENTS

Safety	1
Operating	7
Replacement Parts	12
Service Intervals	13
Service	14
Troubleshooting	26
Storing Machine.....	28
Assembly	30
Specifications	33
Warranty	35
Index	39

All information, illustrations and specifications in this manual are based on the latest information at the time of publication. The right is reserved to make changes at any time without notice.

COPYRIGHT© 2001
Deere & Co.

John Deere Worldwide Commercial and
Consumer Equipment Division

All rights reserved
Previous Editions
COPYRIGHT©

OMGC00550 A1 - English

SAFETY

Understanding The Machine Safety Labels

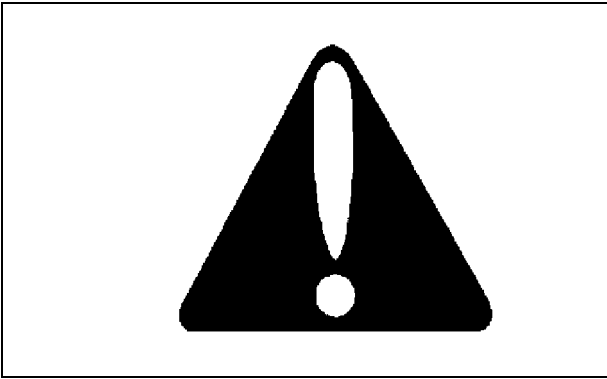

The machine safety labels shown in this section are placed in important areas on your machine to draw attention to potential safety hazards.

On your machine safety labels, the words DANGER, WARNING, and CAUTION are used with this safety-alert symbol, (▲). DANGER identifies the most serious hazards.

The operator's manual also explains any potential safety hazards whenever necessary in special safety messages that are identified with the word, CAUTION, and the safety-alert symbol, (▲).

backwards.

- Remove objects that could be thrown by the blade.
- Keep safety devices in place and working.

DANGER: KEEP HANDS AND FEET AWAY

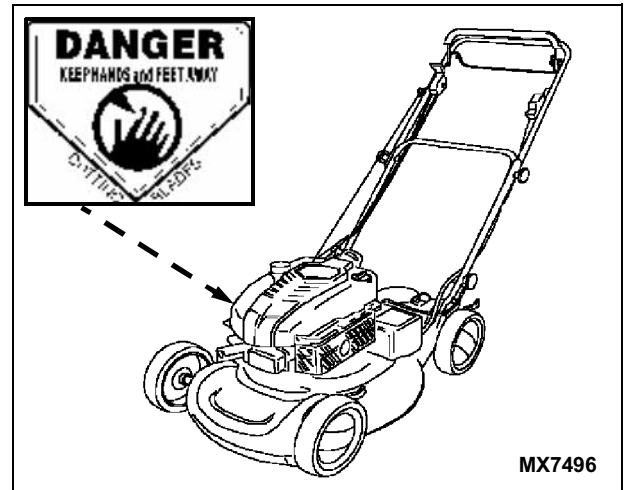

Cutting Blades

WARNING: AVOID SERIOUS INJURY OR DEATH

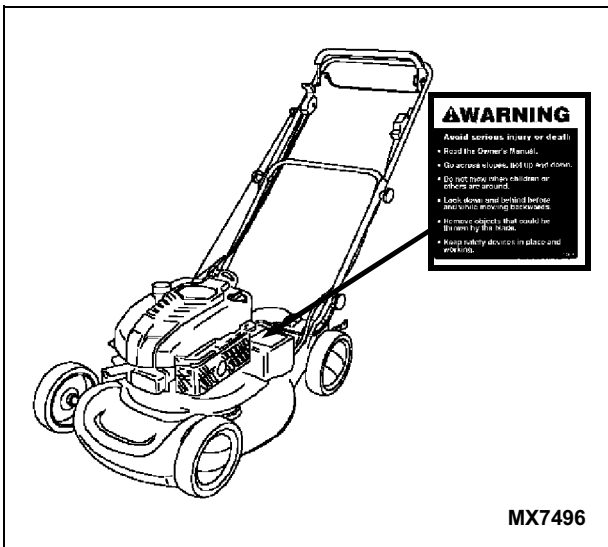

- Read the Owner's Manual.
- Go across slopes, not up and down.
- Do not mow when children or others are around.
- Look down and behind before and while mowing

DANGER: ROTATING BLADE

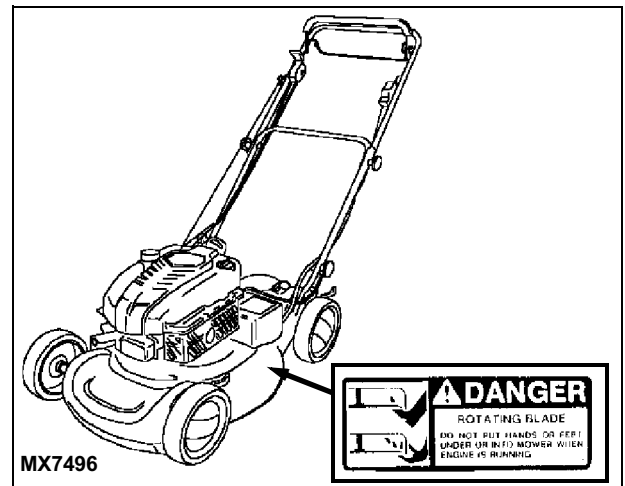

Do not put hands or feet under or into mower when engine is running

SAFETY

DANGER:

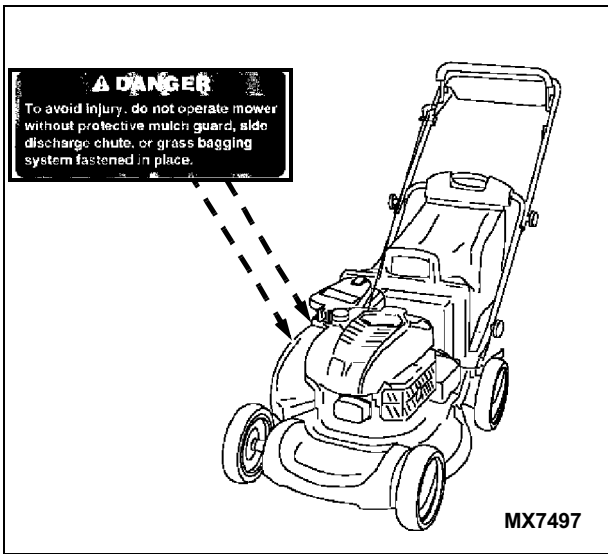

To avoid injury, do not operate mower without protective mulch guard, side discharge chute or grass bagging system fastened in place.

CAUTION

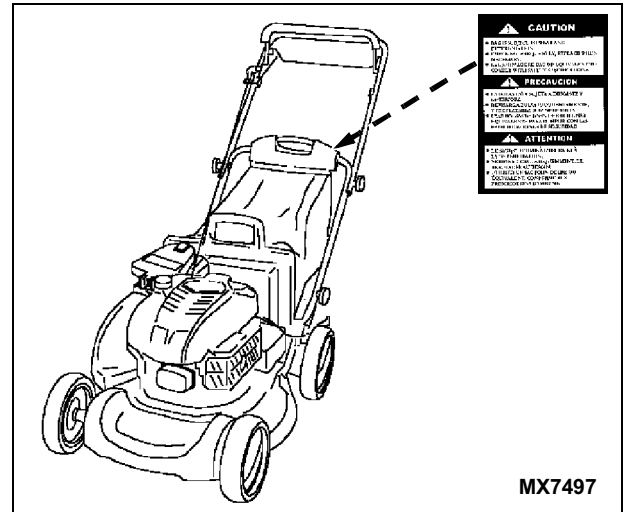

- Bag is subject to wear deterioration.
- Check bag frequently, replace when necessary.
- Use John Deere bag or equivalent to comply with safety specifications.

DANGER: ROTATING BLADE

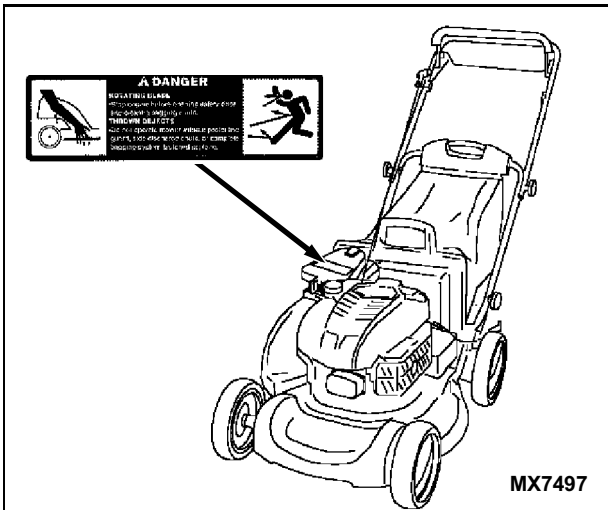

- Stop engine before opening safety door and clearing bagging chute.

THROWN OBJECTS

- Do not operate mower without protective guard, side discharge chute, or complete bagging system fastened in place.

WARNING

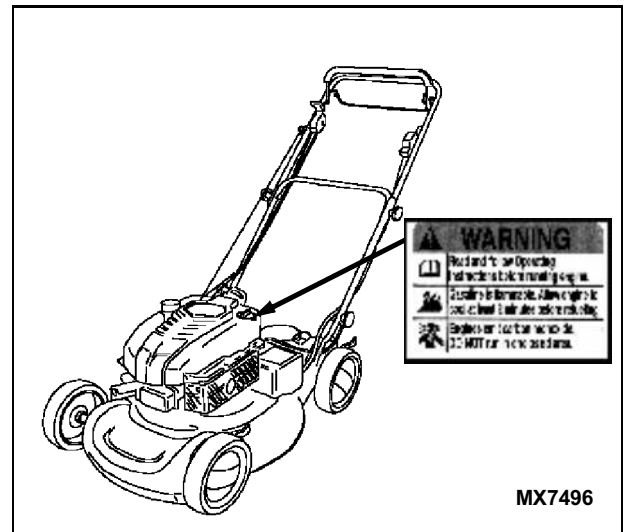

- Read and follow Operating Instructions before running engine.
- Gasoline is flammable. Allow engine to cool at least 2 minutes before refueling.
- Engines emit carbon monoxide, do not run in enclosed area.

SAFETY

CAUTION

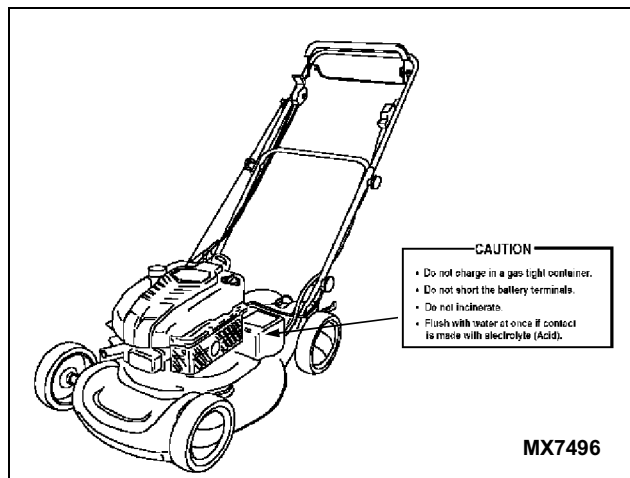

Picture Note: Located on battery

- Do not charge in a gas tight container.
- Do not short the battery terminals.
- Do not incinerate.
- Flush with water at once if contact is made with electrolyte (Acid).

WARNING & CAUTIONS

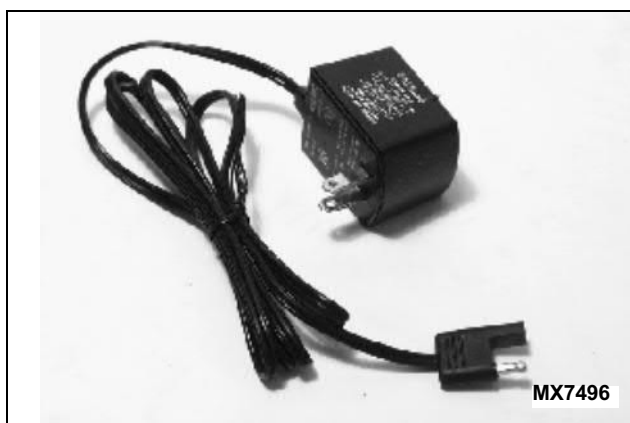

Picture Note: Located on Charger

Warning

Charge only 10 or 12 cell NI-CAD or 6 cell lead acid type rechargeable batteries. Other types of batteries may rupture causing personal injury and damage.

Caution: Class 2.

Do not expose to liquid, vapor, or rain.

Caution: Use Indoors Only

Battery charger for use with electric start lawn mower.

Certification Label

This OPEI label on your mower indicates that this model has been certified by an independent laboratory for compliance with American National Standard B-71.1, "Safety Specifications" for Power Lawn Mowers, Lawn and Garden Tractors, and Lawn Tractors.

Emission Control System Certification Label

NOTE: Tampering with emission controls and components by unauthorized personnel may result in severe fines or penalties. Emission controls and components can only be adjusted by EPA and/or CARB authorized service centers. Contact your John Deere Commercial and Consumer Equipment Retailer concerning emission controls and component questions.

The presence of an emissions label signifies that the engine has been certified with the United States Environmental Protection Agency (EPA) and/or California Air Resources Board (CARB).

The emissions warranty applies only to those engines marketed by John Deere that have been certified by the EPA and/or CARB; and used in the United States and Canada in off-road mobile equipment.

Emission Compliance Period

If your engine has the emission compliance category listed on the emission control system certification or air index label, this indicates the number of operating hours for which the engine has been certified to meet EPA and/or CARB emission requirements. The following table provides the engine compliance period in hours associated with the category found on the certification label.

Agency	Category	Hours
EPA	C	250
EPA	B	500
EPA	A	1000
CARB	Moderate	125
CARB	Intermediate	250

SAFETY

Agency	Category	Hours
CARB	Extended	500

Operate Safely

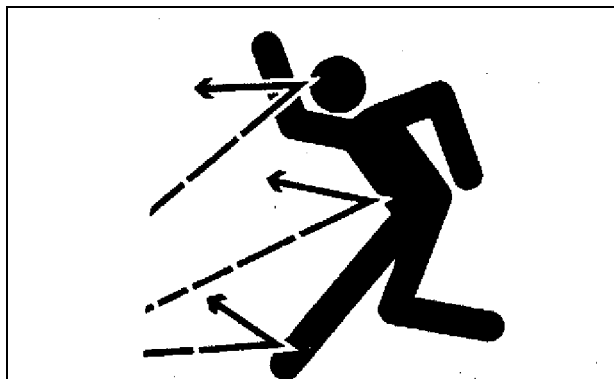

- Inspect machine before you operate. Be sure hardware is tight. Repair or replace damaged, badly worn, or missing parts. Be sure proper guards, plates, grass catcher, or other safety protective devices are in good condition and fastened in place. Make any necessary adjustments before you operate.
- Clear work area of objects that might be thrown. Keep people and pets out of the work area. Stop machine if anyone enters the area.
- If you hit an object, stop the machine and inspect it. Make repairs before you operate. Keep machine properly maintained and in good working order.
- Do not leave machine unattended when it is running.
- Only operate during daylight or with good artificial light.
- Be sure of footing. Be especially careful when you pull machine backwards with the engine running.
- Mow across a hill - not up and down. Be careful when you change direction on a slope. Do not mow excessively steep slopes.
- Do not mow wet grass. Reduced traction could cause you to slip.
- Keep a firm hold on the machine handle.
- Do not wear radio or music headphones while operating the machine. Safe operation requires your full attention.
- Do not operate mower if you are under the influence of drugs or alcohol.

Rotating Blades are Dangerous - Protect Children and Prevent Accidents

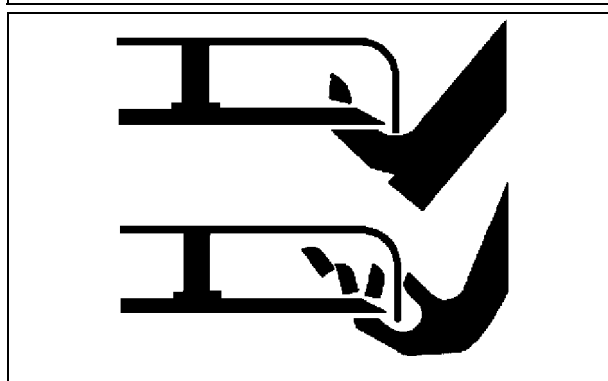
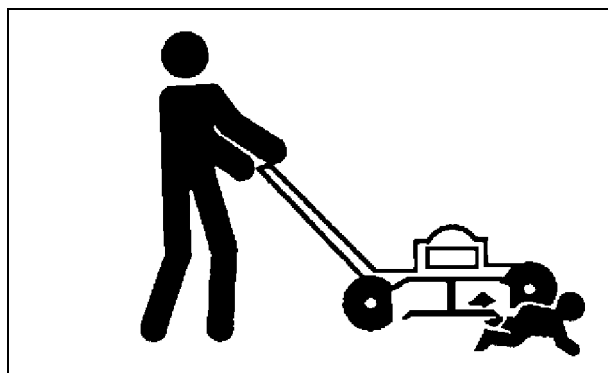

Protect Children:

- Never assume that children will remain where you last saw them. Children are attracted to mowing activity, so stay alert to the presence of children.
- Keep children in the house when you are operating the machine.
- Turn machine off if a child enters the area.
- Use extra care when you come to blind corners, shrubs, trees, or other objects that may block your vision.
- Do not let children or an untrained person operate the machine.

Help Prevent Serious Or Fatal Accidents:

- Be alert at all times, people especially children can move quickly into the area before you know it.
- Stop the blade when crossing gravel drives, walks, or roads.
- Shut off blades when you are not mowing.
- Keep hands, feet, and clothing away from rotating blades.

SAFETY

Wear Appropriate Clothing

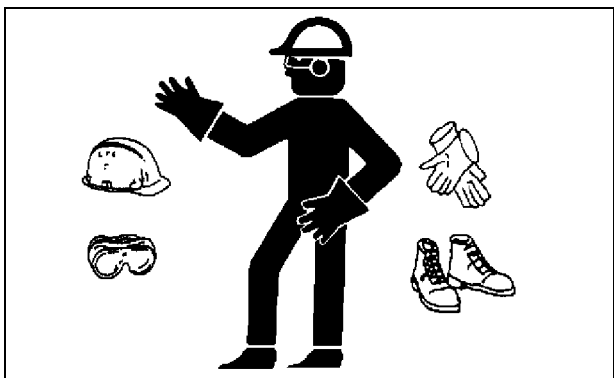

- Wear close fitting clothing and safety equipment appropriate for the job.
- Do not operate the equipment when barefoot or wearing open sandals. Always wear substantial footwear.
- Always wear safety goggles or safety glasses with side shields when operating the mower.
- Loud noise can cause impairment or loss of hearing, wear a suitable protective device such as earplugs.

Practice Safe Maintenance



- Understand service procedure before doing work. Keep area clean and dry.
- Never lubricate, service, or adjust machine while it is moving. Keep safety devices in place and in working condition. Keep hardware tight.
- To prevent them from getting caught, keep hands, feet, clothing, jewelry, and long hair away from any moving parts.
- Before servicing machine, disengage all power and stop the engine. Let engine cool.
- Securely support any machine elements that must be raised for service work.
- Keep all parts in good condition and properly installed.

Fix damage immediately. Replace worn or broken parts. Remove any buildup of grease, oil, or debris.

- Unauthorized modifications to the machine may impair its function and safety.

Avoid Injury from Contacting Blade

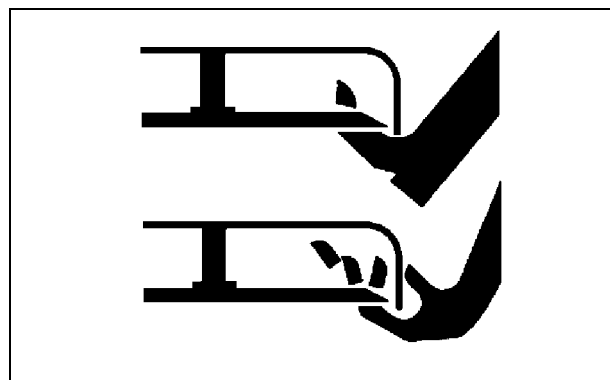

Before you unplug or adjust machine:

- Stop the engine.
- Wait for blade to stop.
- Keep hands, feet and clothing away from blade when engine is running.

Prevent Fires

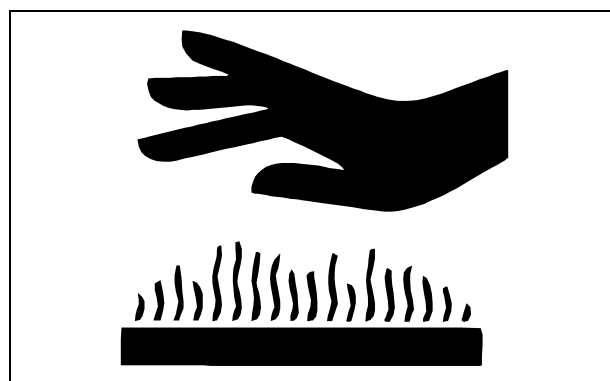

- Never remove fuel cap, or add fuel with engine running or hot. Allow engine to cool for several minutes.
- Never store equipment with fuel in the tank inside a building where fumes may reach an open flame or spark.
- Allow engine to cool before storing in any enclosure.
- To reduce fire hazard, keep engine free of grass, leaves, or excessive grease.

SAFETY

Handling Waste Products

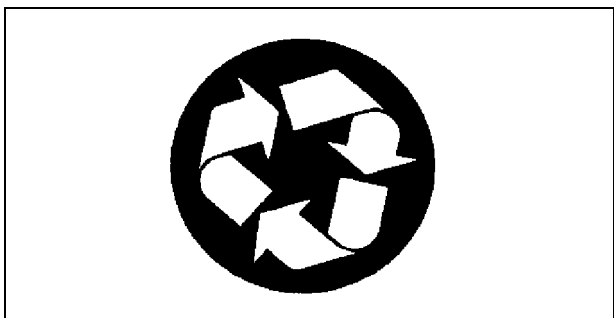

- Waste products, such as, used oil, fuel, and batteries, can harm the environment and people.
- Do not use beverage containers for waste fluids - someone may drink from them.
- See your local Recycling Center or John Deere dealer to learn how to recycle or get rid of waste products.
- A Material Safety Data Sheet (MSDS) provides specific details on chemical products: physical and health hazards, safety procedures, and emergency response techniques. The seller of the chemical products used with your machine is responsible for providing the MSDS for that product.

Handling Fuel Safely

Fuel and fuel vapors are highly flammable:

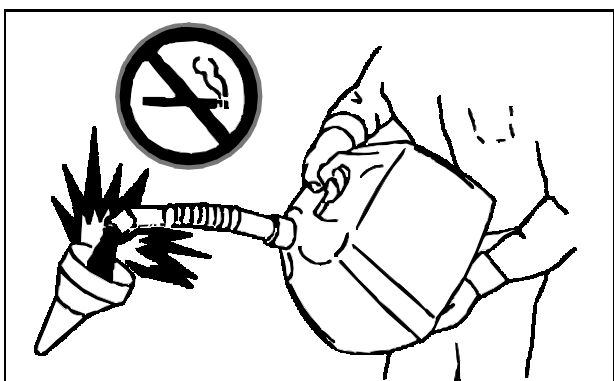

- Do not refuel machine while you smoke, when machine is near an open flame or sparks, or when engine is running. stop engine.
- Fill fuel tank outdoors.
- Prevent fires: clean oil, grease and dirt from machine. Clean up spilled fuel immediately.
- Do not store machine with fuel in tank in a building where fumes may reach an open flame or spark.
- Prevent fire and explosion caused by static electric discharge. Use only non-metal, portable fuel containers approved by the Underwriter's Laboratory (U.L.) or the

American Society for Testing & Materials (ASTM). If using a funnel, make sure it is plastic and has no screen or filter.

- Static electric discharge can ignite gasoline vapors in an ungrounded fuel container. Remove the fuel container from the bed of a vehicle or the trunk of a car and place on the ground away from the vehicle before filling. Keep nozzle in contact with container opening while filling.



- When practical, remove equipment from trailers or truck beds and refuel them on the ground. If this is not possible, use a portable, plastic fuel container to refuel equipment on a truck bed or trailer.
- Do not use methanol gasoline. Methanol is harmful to the environment and to your health.

OPERATING

Controls

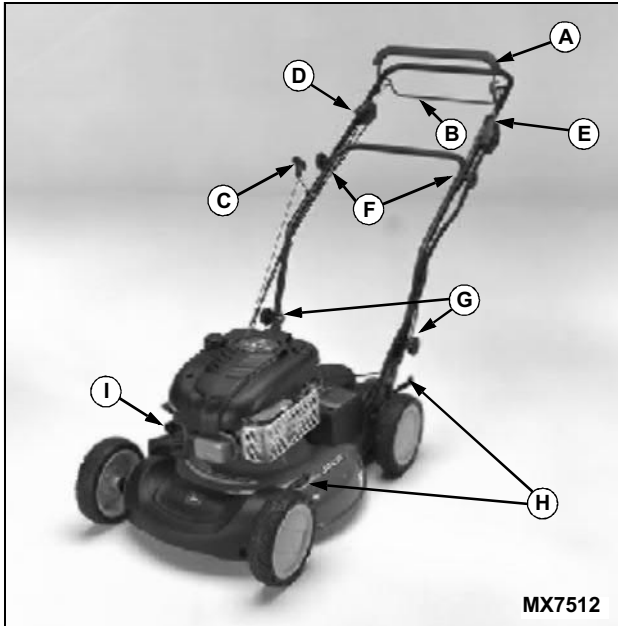

- A - Blade Control Lever
- B - Traction Clutch Lever
- C - Starter Handle (Manual Start)
- D - Travel Speed Lever
- E - Key Switch (Electric Start)
- F - Fold Handle Knobs
- G - Handle Height Knob
- H - Cutting Height Levers
- I - Primer Bulb

Adjusting Handle Height

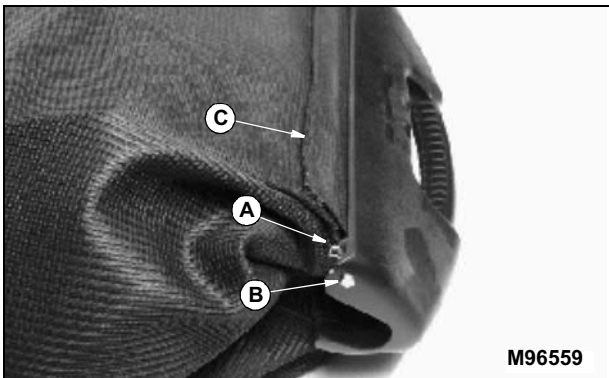

NOTE: If you are using a bagger with your mower, bag may prevent lowering of handle. Remove clip (A) to remove rod (B). Remove rod from lower position (C) and insert in upper position as shown to lengthen bag.

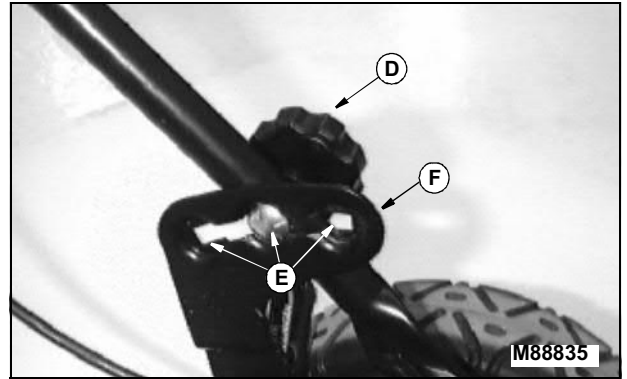

1. Loosen knob (D) on side of handle.
2. Pivot handle to desired height at one of three positions (E) within slotted adjustment bracket (F).
3. Tighten knob.
4. Repeat on other side.

Adjusting Cutting Height



CAUTION: Avoid injury! Rotating blades are dangerous. Before you adjust cutting height: Stop engine and wait for moving parts to stop.

NOTE: Adjust both levers to same height except for two lowest cutting heights (A and B on following chart). At two lowest cutting heights, raise rear lever one notch higher than front lever. This adjustment allows for increased air flow when bagging and side discharging, and provides a larger exit window for clippings when mulching.

Begin at upper cutting height, then adjust downward as desired, to avoid scalping lawn with too low a setting.

OPERATING

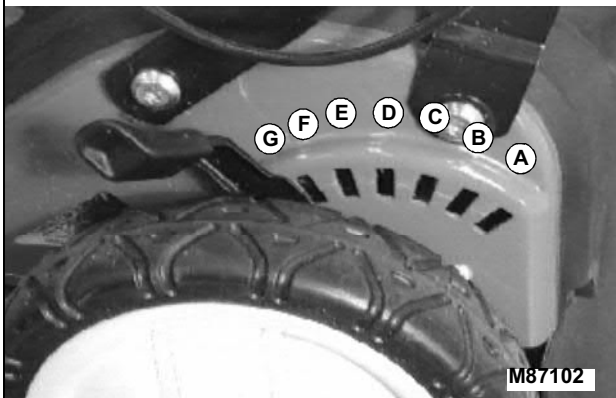
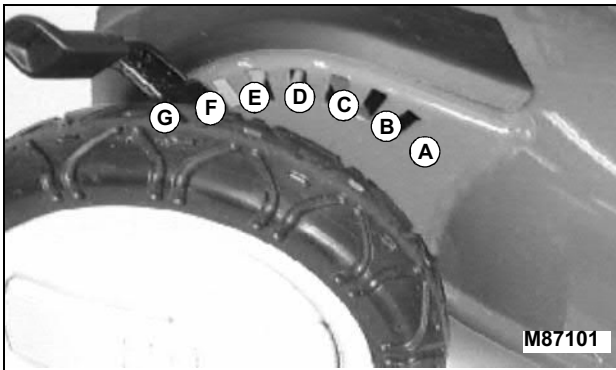

Picture Note: Front wheel shown in top photo.

Key	Cutting Height Adjustments in mm (inches)
(A)	25 mm (1 in.)
(B)	38 mm (1-1/2 in.)
(C)	50 mm (2 in.)
(D)	64 mm (2-1/2 in.)
(E)	75 mm (3 in.)
(F)	90 mm (3-1/2 in.)
(G)	102 mm (4 in.)

Adjusting front wheel height:

1. Lift front of mower deck slightly with one hand to take some weight off wheels.
2. Move height adjustment lever to desired position with other hand.

Adjusting rear wheel height:

1. Lift lower handlebar slightly with one hand to take some weight off wheel.
2. Move height adjustment lever to desired position with other hand.

Testing Safety Systems

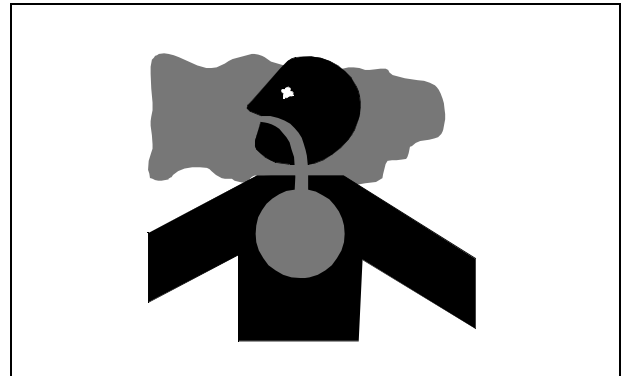

CAUTION: Avoid injury! Engine exhaust fumes contain carbon monoxide and can cause serious illness or death.

Move the vehicle to an outside area before running the engine.

Do not run an engine in an enclosed area without adequate ventilation.

- Connect a pipe extension to the engine exhaust pipe to direct the exhaust fumes out of the area.
- Allow fresh outside air into the work area to clear the exhaust fumes out.

Use the following checkout procedure to check for normal operation of machine.

If there is a malfunction during one of these procedures, do not operate machine. **See your John Deere dealer for service.**

Perform these tests in a clear open area. Keep bystanders away.

Testing Blade/Engine Control Lever

1. Start engine.
2. Release blade/engine control lever.



CAUTION: Avoid injury! Rotating blades are dangerous. Do not look under mower or put hands under mower to view blade rotation. Listen for blade to stop.

3. Listen for blade and engine to stop.

Result: Blade and engine should stop within three seconds. If blade and engine do not stop in the correct time, there is a problem with your machine safety system.

OPERATING

Starting Engine



CAUTION: Avoid injury! Engine exhaust fumes can cause sickness or death. Run engine only in a ventilated area.

If engine is run in an enclosed area, open doors to bring in outside air.

IMPORTANT: Avoid damage! To help prevent damage to recoil starter and band brake, do not start engine:

- When blade is under load, such as in heavy grass.
- When blade control lever is released.

NOTE: This engine can be started manually or with the electric start.

Manual Start Mode

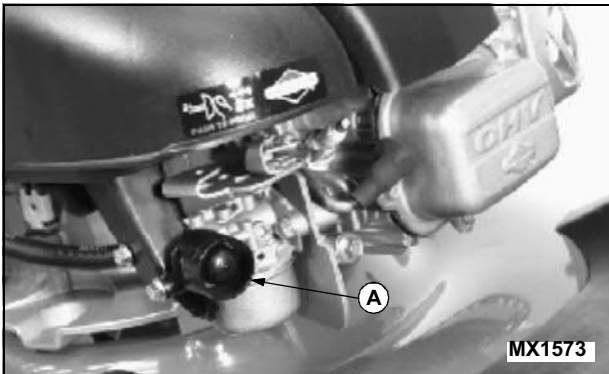

1. Prime engine by pressing primer bulb (A):
 - Cold engine - 3 times.
 - Warm engine - if engine does not start on first or second pull, press primer bulb 1 or 2 times.



CAUTION: Avoid injury! When engine is running, blade is turning. Keep hands, feet and clothing away from the blade.

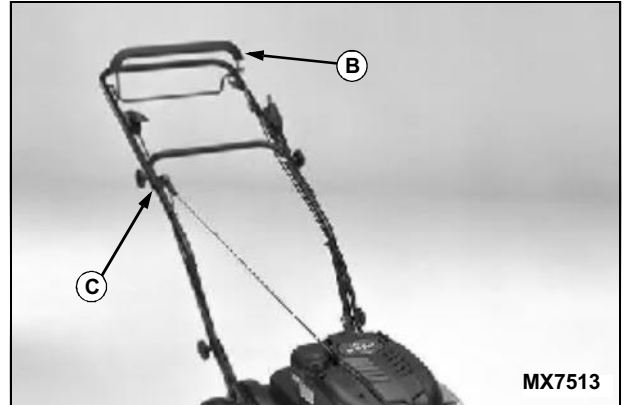

2. Hold blade control lever (B) against handle.
3. Pull starter handle (C) until you feel resistance. Then pull fast and steady.
4. Release blade control lever to stop engine.

Electric Start Mode

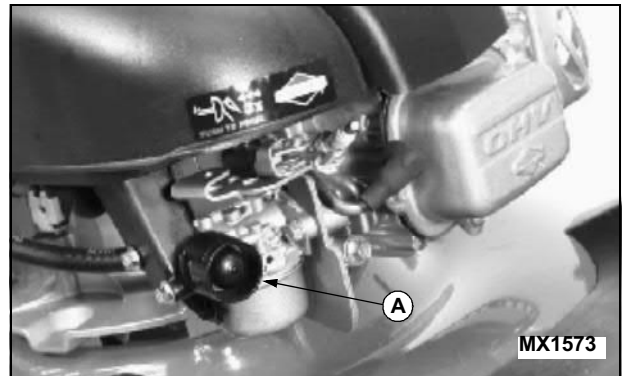

1. Prime engine by pressing primer bulb (A):
 - Cold engine - 3 times.
 - Warm engine - if engine does not start on first or second pull, press primer bulb 1 or 2 times.

OPERATING

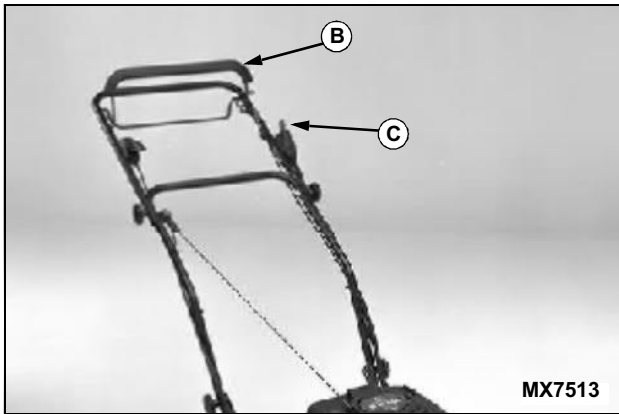

2. Hold blade control lever (B) against handle.

NOTE: If battery is not used for extended time, you may have to charge it. If the battery is not extremely discharged, it can be charged by running the engine or by using the battery charger.

3. Turn key (C) to start engine and crank engine 5 seconds:

- a. If engine does not start, wait 10 seconds.
- b. Crank engine again 5 seconds.

Repeat procedure if necessary. If engine still does not start, use the recoil starter or charge the battery.

4. Release key when engine starts.
5. Check mower operation.
6. Release blade control lever to stop engine.

Stopping Engine

Release handle and levers:



CAUTION: Avoid injury! If blade does not stop within 3 seconds after you release blade stop lever, see your John Deere dealer.

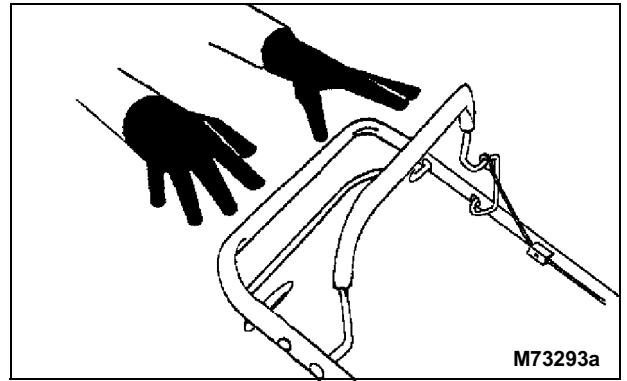

- Mower will stop.
- Blade will stop.
- Engine will stop.

Operating the Machine



CAUTION: Avoid injury! When engine is running, blade is turning.
Keep hands, feet and clothing away from blade.



1. Hold blade control lever (A) against handle and start engine.

- Engine and blade will stop if blade control lever is released.

2. Select a travel speed.

OPERATING

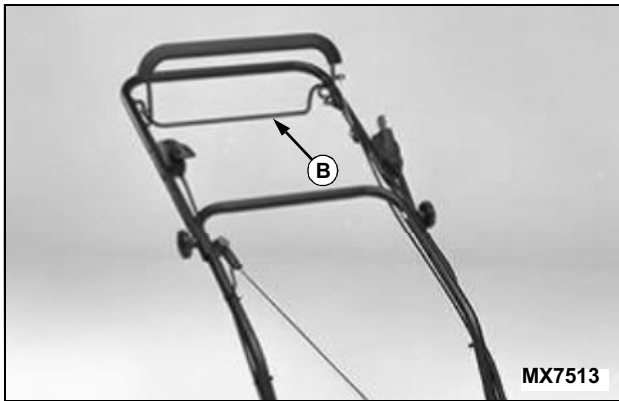

3. To begin mowing, pull and hold traction clutch lever (B) against handle while continuing to hold blade control lever against handle.
4. To stop forward motion or turn the machine, release lever (B).
5. Release both levers to stop forward motion, as well as the blade and engine.

Selecting a Travel Speed

NOTE: It is normal for rear wheels to make a clicking noise when mower is manually pushed.

Travel speeds:

- 1st Gear: 3.1 km/h (1.9 mph)
- 2nd Gear: 3.9 km/h (2.4 mph)
- 3rd Gear: 5.0 km/h (3.1 mph)

To change travel speeds:

NOTE: Mower travel speed can be changed when the traction clutch lever is engaged and the mower is moving forward.

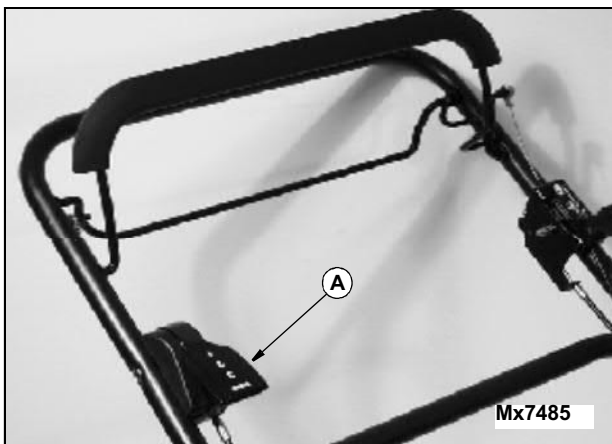

- Raise or lower speed control lever (A) to engage desired gear.

Selecting Proper Mower Blade

- **Mulching Blade:** The mower comes equipped with a mulching blade. This blade can be used for mulching, side discharge and also occasional bagging.
- **Bagging Blade:** Designed specifically for bagging applications, this blade should be installed when ultimate bagging performance is desired.

Using Side Discharge Chute



CAUTION: Avoid injury! Do not operate mower unless grass bag assembly, side discharge chute or mulch guard is in place.

1. Release blade control lever to stop engine.



2. Remove mulch guard knob (A) from threaded stud.

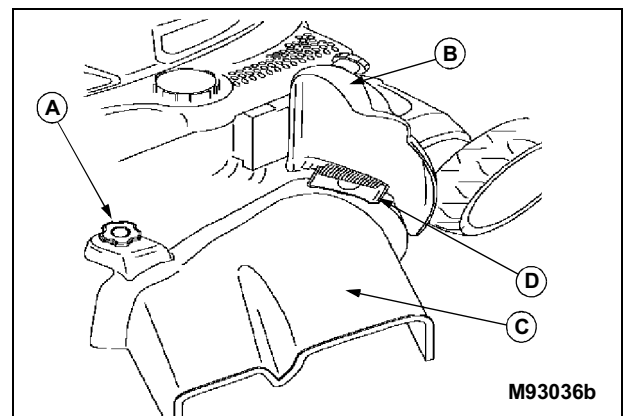

3. Lift and hold spring loaded mulch guard (B) up.
4. Install side discharge chute (C).
 - Slide side discharge chute under mulch guard mounting bracket (D) and lower onto threaded stud.
 - Lower mulch guard.
 - Install and tighten knob (A) onto threaded stud.

REPLACEMENT PARTS

Service Literature

If you would like a copy of the Parts Catalog or Technical Manual for this machine call:

- **U.S. & Canada:** 1-800-522-7448.
- **All Other Regions:** Your John Deere dealer.

Parts

We recommend John Deere quality parts and lubricants, available at your John Deere dealer.

Part numbers may change, use part numbers listed below when you order. If a number changes, your dealer will have the latest number.

When you order parts, your John Deere dealer needs your machine serial number and engine serial number. These are the numbers that you recorded in the Product Identification section of this manual.

Part Numbers

ITEM	PART NUMBER
Air Cleaner	
• Foam Pre-cleaner	GC00440
• Paper Element	GC00441
Traction Drive Belt	GC00081
Mulching Blade (Standard)	GC00344
Bagging Blade (Optional)	GC00175
Spark Plug	Champion RC12YC

(Part numbers are subject to change without notice. Part numbers may be different outside the U.S.A.)

SERVICE INTERVALS

Service Intervals

Please use the following timetables to perform routine maintenance on your machine. Service procedures included in this manual but not on this chart are to be performed on an as needed basis.

IMPORTANT: Avoid damage! If you operate mower in extreme heat, dust or other severe conditions, service more often than shown below.

Before Each Use

- Check oil level.

After Each Use

- Clean the mower.

After First 5 Hours

- Change engine oil. (Break-in)
- Lubricate mower axles.
- Lubricate drive shaft hub bushings.

Every 25 Hours Or Once a Year

- Tighten blade bolt.
- Clean or replace air cleaner paper element.
- Clean and gap spark plug.
- Clean belt and transmission area.
- Change engine oil.
- Lubricate mower axles.
- Lubricate drive shaft hub bushings.
- Adjust transmission cable.

SERVICE

Engine Warranty Maintenance Statement

Maintenance, repair, or replacement of the emission control devices and systems on this engine, which are being done at the customer's expense, may be performed by any nonroad engine repair establishment or individual. Warranty repairs must be performed by an authorized John Deere dealer.

Adjusting Carburetor

NOTE: Carburetor is calibrated by the engine manufacturer and should not require any adjustments.

NOTE: If engine is operated at altitudes above 1829 m (6,000 ft.), some carburetors may require a special high altitude main jet. See your John Deere dealer.

If engine is hard to start or runs rough, check the TROUBLESHOOTING section of this manual.

After performing the checks in the troubleshooting section and your engine is still not performing correctly, contact your John Deere dealer.

Avoid Fumes



CAUTION: Avoid injury! Engine exhaust fumes can cause sickness or death:

- If it is necessary to run an engine in an enclosed area, use an exhaust pipe extension to remove the fumes.
- Always try to work in a well-ventilated area.

Engine Oil

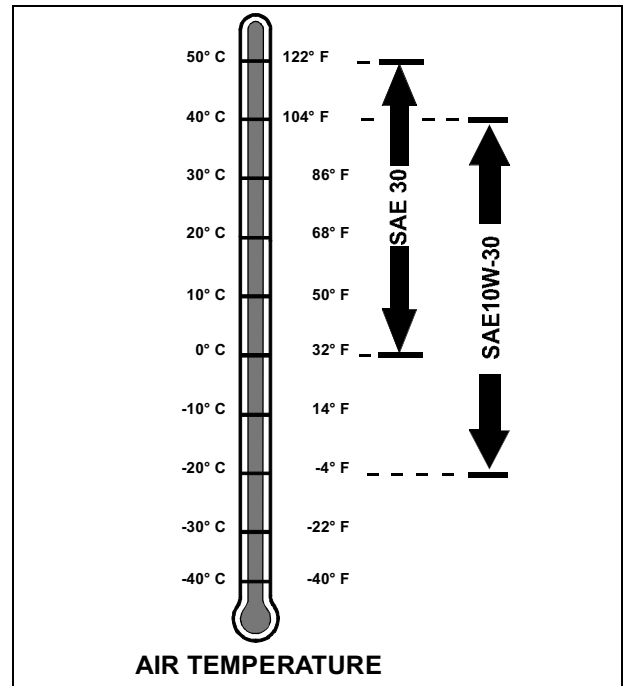

Use oil viscosity based on the expected air temperature range during the period between oil changes.

The following John Deere oils are preferred:

- TORQ-GARD SUPREME® (SAE 30)

The following John Deere oils are also recommended, based on their specified temperature range:

- TURF-GARD® (SAE 10W-30)
- PLUS-4® (SAE 10W-30)

Other oils may be used if above John Deere oil is not available, provided they meet one of the following specifications:

- SAE 10W-30—API Service Classification SG or higher
- SAE 30—API Service Classification SC or higher

Checking Engine Oil Level



CAUTION: Avoid injury! Before you check or add oil:

- Stop engine. Let it cool.

IMPORTANT: Avoid damage! Change oil after first 5 hours of operation.

1. Park mower on level surface.

SERVICE

Changing Engine Oil

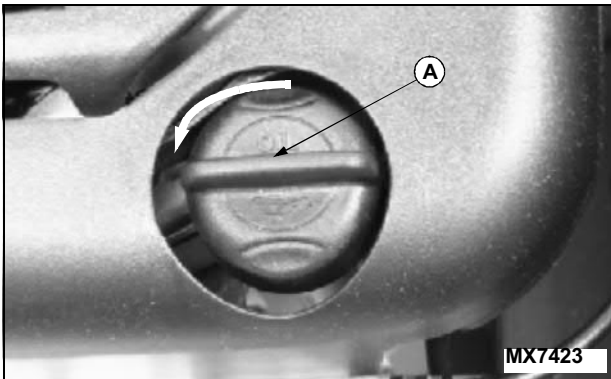

2. Turn oil dipstick (A) 1/4 turn counterclockwise. Remove dipstick and wipe with clean cloth.
3. Install dipstick. Turn dipstick 1/4 turn clockwise and tighten.

IMPORTANT: Avoid damage! If oil level is below ADD mark, do not run engine.

4. Remove dipstick. Check oil level. Oil should be between ADD and FULL marks shown on dipstick, not above FULL mark.

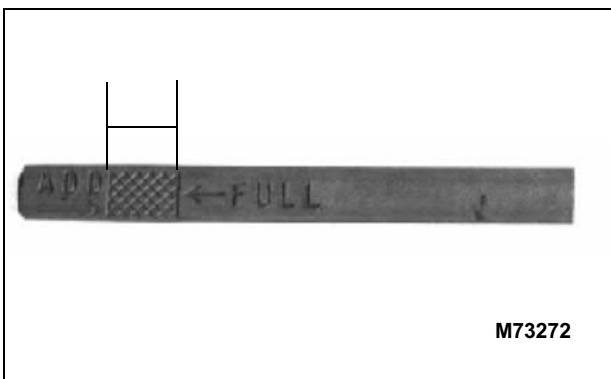

5. Add oil if necessary.
6. Install and tighten dipstick.



CAUTION: Avoid injury!

- Used oil will harm environment and people if it is dumped on the ground or into a drain or a body of water. Call your local Recycling Center or John Deere dealer to learn how to recycle used oil.
- Engine may be hot. Use caution to avoid burns to hands.
- Fuel is highly flammable. To prevent fuel spillage from occurring, drain fuel from tank before tipping mower to drain oil.

IMPORTANT: Avoid damage!

- Change oil after first 5 hours of operation.
- Change oil while engine is warm.
- If mower is not operated 25 hours during the mowing season, change oil before storing mower.
- Help prevent air cleaner damage and hard starting. Turn mower onto its left side when servicing.

1. Park mower on level surface.
2. Drain fuel from tank or run engine until fuel tank is empty or near empty.
3. Stop engine and disconnect spark plug wire.

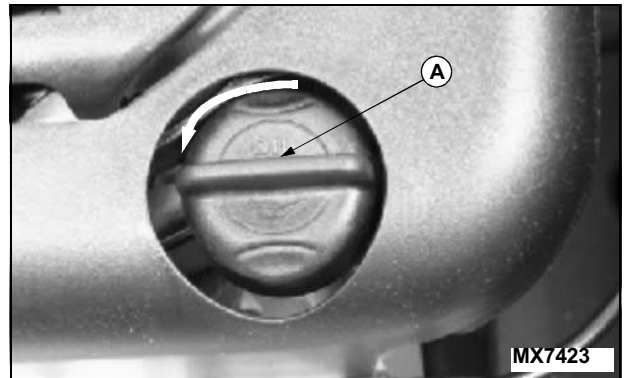

4. Turn oil dipstick (A) 1/4 turn counterclockwise and remove.

SERVICE

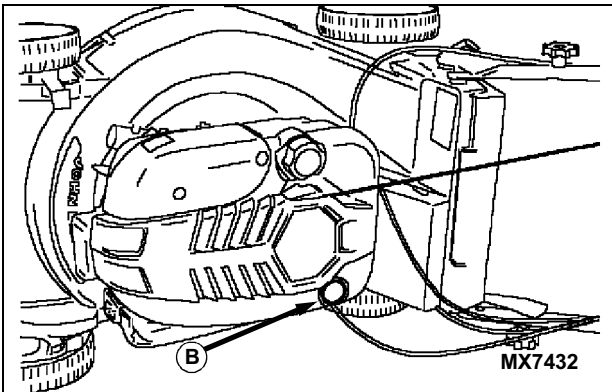

5. Insert plastic drain tube supplied with mower firmly inside oil filler tube opening (B).
6. Place drain pan on left side of mower.

IMPORTANT: Avoid damage! To help prevent air cleaner damage and hard starting:

- Turn mower on its left side.

7. Turn mower onto its left side.
8. Allow engine oil to drain from dipstick filler tube location into drain pan.
9. After oil has drained, return mower to upright position.
10. Remove plastic drain tube. Clean area around filler tube.
11. Add 0.47 L (16 oz) oil through dipstick filler tube.
12. Install dipstick. Turn dipstick 1/4 turn clockwise to tighten.
13. Remove dipstick. Check oil level. Add oil to FULL mark if necessary.
14. Install and tighten dipstick.
15. Connect spark plug wire.

Checking and Cleaning Air Cleaner Element

1. Park mower on level surface.



CAUTION: Avoid injury! Touching hot surfaces can burn skin. The engine and components will be hot if engine has been running. Allow engine to cool before servicing.

2. Let engine cool.
3. Disconnect spark plug wire.
4. Clean dirt and debris from air cleaner cover.

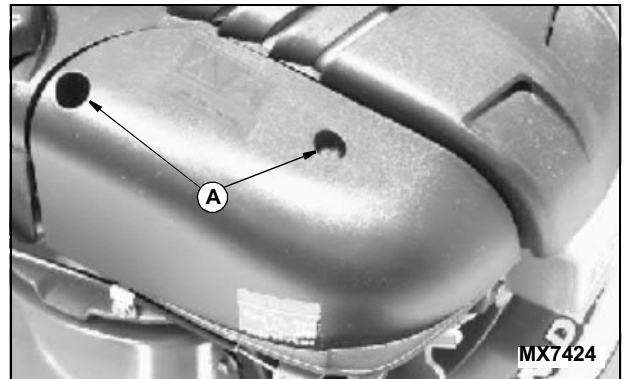

5. Loosen screws (A) and remove cover.



6. Inspect foam pre-cleaner (B) without removing it. If foam pre-cleaner is dirty:

- a. Remove it from the filter carefully, leaving paper element in air cleaner housing.
- b. Wash pre-cleaner in solution of warm water and liquid detergent.
- c. Rinse pre-cleaner thoroughly. Squeeze out excess water in dry cloth until pre-cleaner is completely dry.

IMPORTANT: Avoid damage! Dirt and debris can enter the engine through a damaged filter element.

- Do not wash paper element.
- Do not attempt to clean paper element by tapping against another object.
- Do not use pressurized air to clean element.
- Replace element only if it is very dirty, damaged, or has a cracked seal.

7. Inspect paper element without removing it. If paper element is damaged or dirty, remove and replace with new element.
8. Clean air cleaner base carefully, preventing any dirt from falling into carburetor.
9. Install foam pre-cleaner onto paper element and install into air cleaner base.

SERVICE

10. Close cover and tighten screws. Do not overtighten.
11. Connect spark plug wire.

Cleaning and Gapping Spark Plug



CAUTION: Avoid injury! Before you remove spark plug:

- Stop engine. Let engine cool.

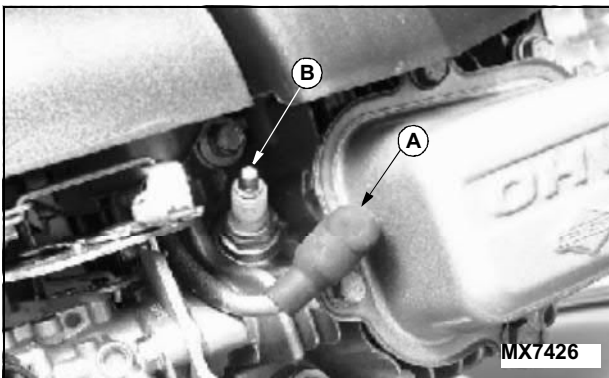

1. Park mower on level surface.
2. Disconnect spark plug wire (A). Remove spark plug (B).
3. Carefully wire brush carbon from plug. Do not clean it with abrasives in a machine.
4. Inspect plug for damage. Replace damaged plug.
5. Adjust gap: 0.51 mm (0.02 in.).
6. Install and tighten plug to 20 N•m (15 lb-ft).
7. Connect wire.

Cleaning Engine Cooling Fins



CAUTION: Avoid injury! Before you clean fins:

- Stop engine. Let it cool.
- Wear eye protection to guard against flying debris.

IMPORTANT: Avoid damage! Keep fins clean or engine may overheat.

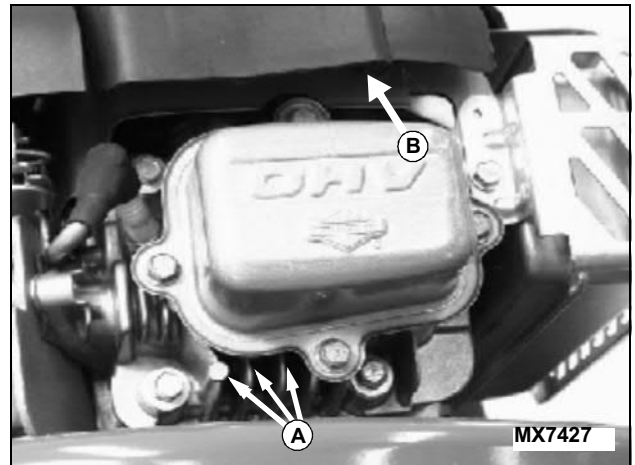

1. Park mower on level surface.
2. Let engine cool.
3. Clean fins (A) and (B) with brush, rag, or compressed air.

Cleaning Drive Belt and Transmission Area



CAUTION: Avoid injury! Before you remove shield:

- Stop engine. Let it cool.
- Do not operate mower without belt shield in place.

SERVICE

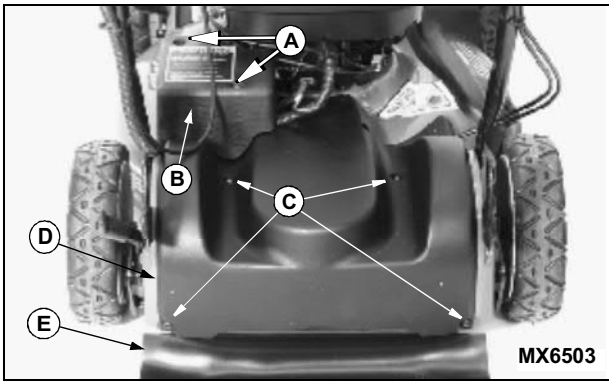

1. Park mower on level surface and stop engine.
2. Disconnect spark plug wire.
3. Remove screws (A) and battery cover (B).
4. Remove screws (C), belt shield (D), and drag flap (E).

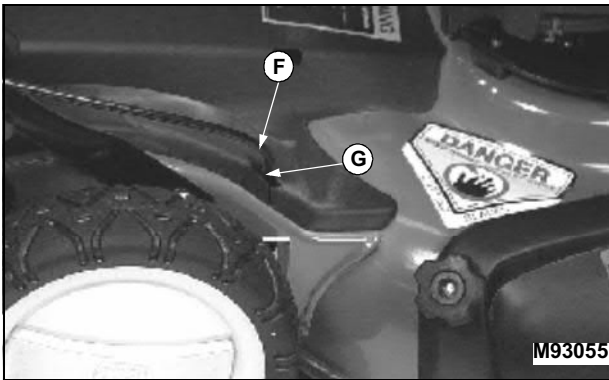

5. Remove control cables (F) from belt shield notch (G).



6. Remove clippings from belt area and top of the transmission.
7. Slide control cable into belt shield notch.
8. Install drag flap and belt shield with screws.
9. Install battery cover.

Checking and Replacing Drive Belt



CAUTION: Avoid injury! Before removing belt shield:

- Stop engine and wait for all moving parts to stop.
- Prevent burns by allowing engine to cool.
- Disconnect spark plug wire.
- Wear protective gloves when service is performed within the mower blade area.
- Do not operate mower without belt shield.

1. Park mower on level surface and stop engine.
2. Disconnect spark plug wire.

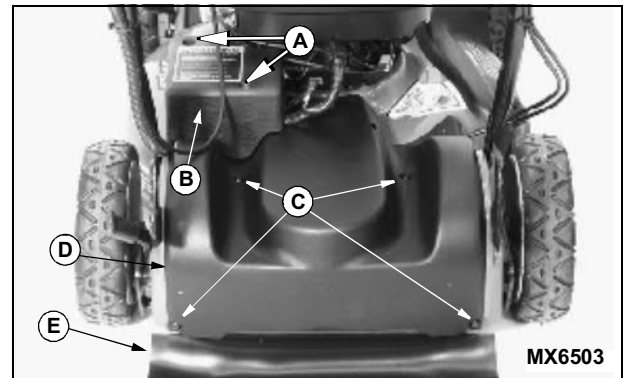

3. Remove screws (A) and battery cover (B).
4. Remove screws (C), belt shield (D), and drag flap (E).

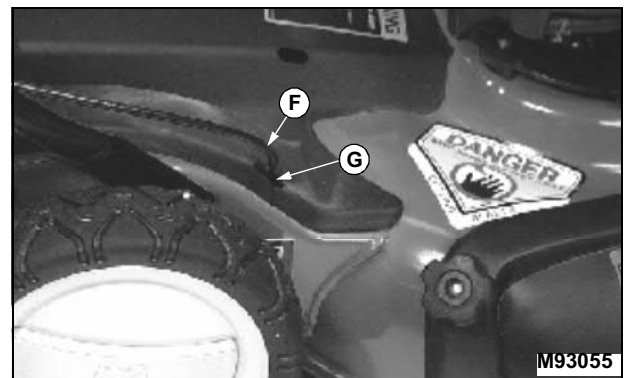

5. Remove control cables (F) from belt shield notch (G).

SERVICE

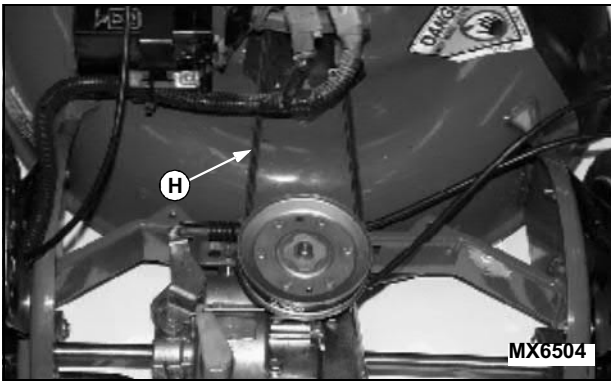

6. Inspect belt (H) for excessive wear or damage.

To Replace Drive Belt:

CAUTION: Avoid injury! Wear protective eyewear when removing belt from drive sheave. Tension spring may come loose.

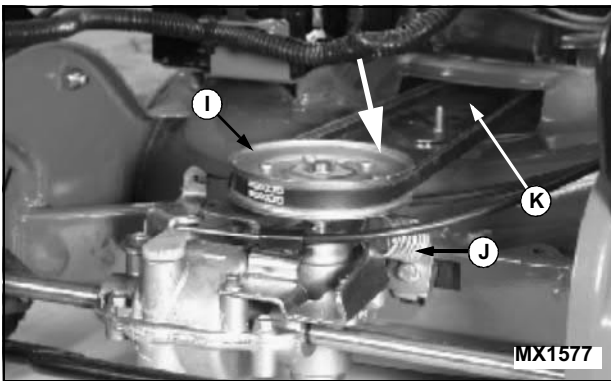

1. Push down on front of drive sheave (I) forward to relieve spring tension on belt.

NOTE: Tension spring (J) may come loose when belt is removed. Install after you replace belt.

2. Remove belt from drive sheave.

3. Move belt through deck opening (K) into underside of mower deck.

4. Turn mower on its left side.

CAUTION: Avoid injury! Mower blades are sharp. Always wear gloves when handling mower blades or working near blades.

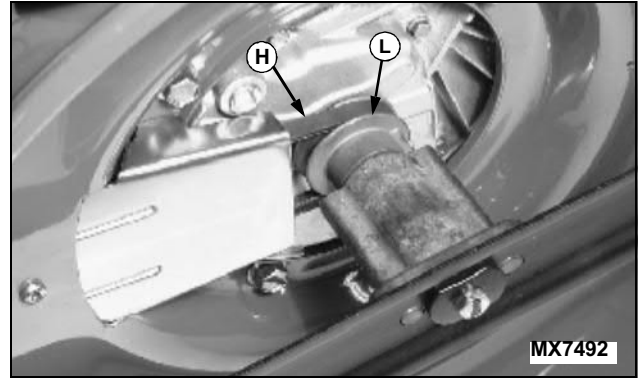

5. Remove drive belt (H) from blade sheave (L) and mower blade.

6. Install new drive belt over mower blade and onto blade sheave.

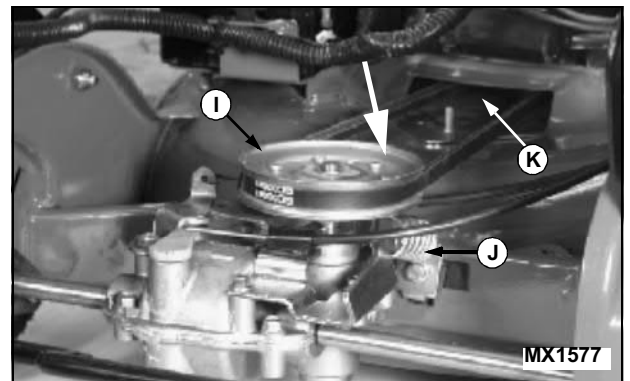

7. Insert belt back through deck opening (K).

8. Return mower to upright position.

9. Install tension spring (J) if removed.

10. Push down on front of drive sheave (I) and install belt on sheave.

11. Slide control cables into belt shield notch.

12. Install drag flap and belt shield with screws.

13. Install battery cover and connect spark plug wire.

SERVICE

Adjusting Transmission Cable



CAUTION: Avoid injury! Help prevent bodily injury. Before removing belt shield:

- Stop engine and wait for all moving parts to stop.
- Prevent burns by allowing engine to cool.
- Disconnect spark plug wire.
- Wear protective gloves when service is performed within the mower blade area.
- Do not operate mower without belt shield.

1. Park mower on level surface and stop engine.
2. Disconnect spark plug wire.

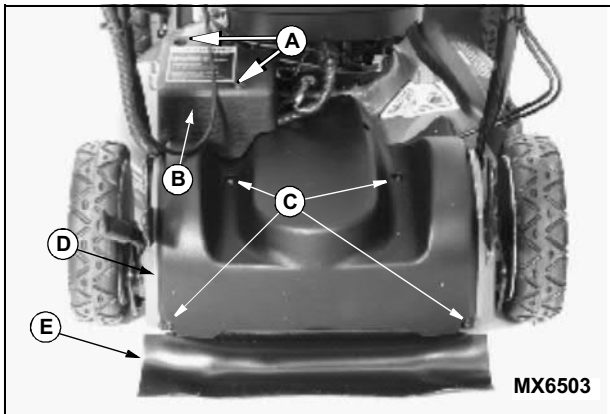

3. Remove screws (A) and battery cover (B).
4. Remove screws (C), belt shield (D), and drag flap (E).



CAUTION: Avoid injury! Wear protective eye wear when removing belt from drive sheave. Tension spring may come loose.

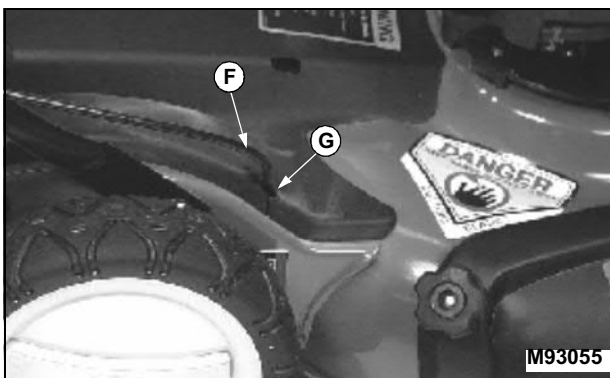

5. Remove control cables (F) from belt shield notch (G).

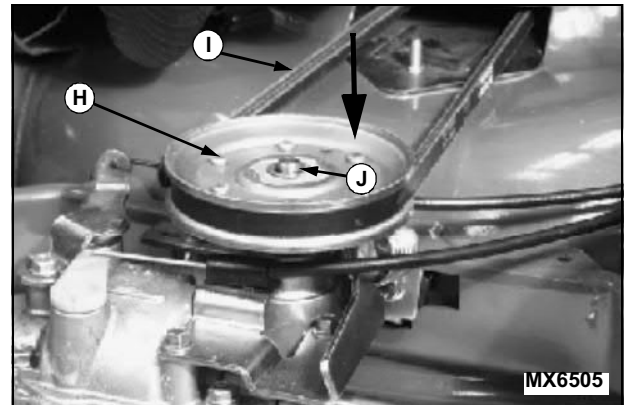

6. Push down on front of drive sheave (H) to relieve spring tension on belt and remove drive belt (I).
7. Remove E-clip (J) and drive sheave.

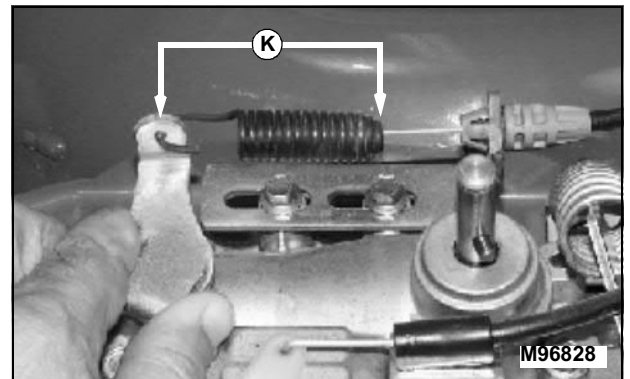

8. Measure the clutch spring length (K) in the relaxed position. Record this value.

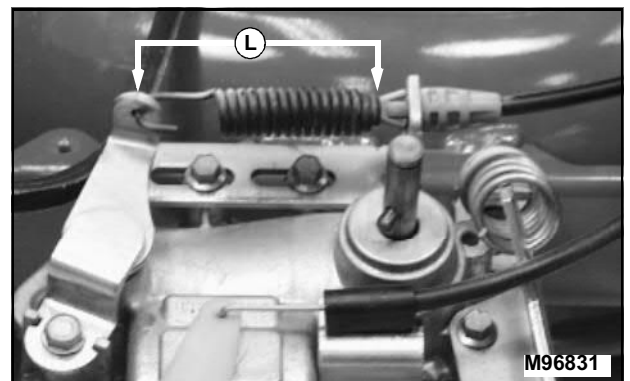

9. Engage the traction clutch lever (at handle bar) and measure the spring length in the extended position (L).
 - The spring extension length (the difference between K and L measurements) must be 10 mm (0.390 in.).

SERVICE

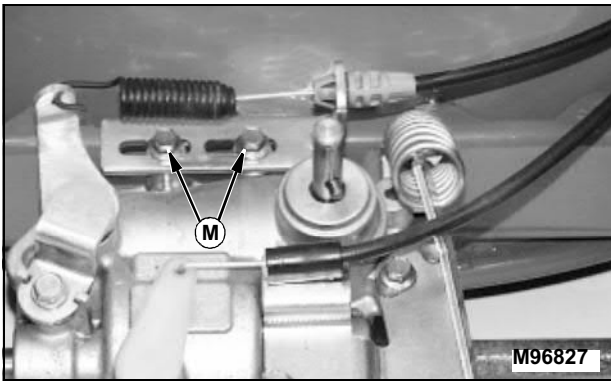

10. Use 8 mm wrench to loosen (but not remove) cable mount bracket capscrews (M) to adjust spring extension.

NOTE: For transmission clutch to operate properly, there must be a certain amount of spring pressure or the transmission will slip and not drive the wheels.

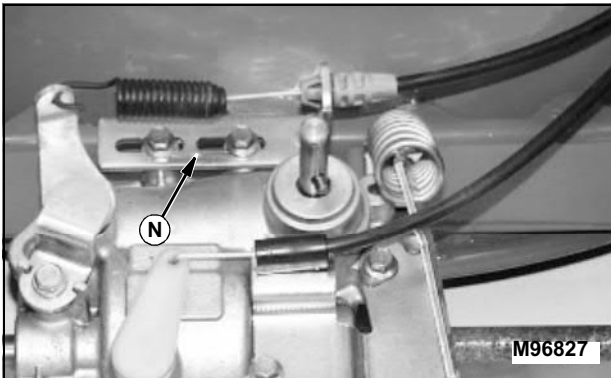

11. Slide bracket (N) the distance needed to obtain 10 mm (0.390 in.) spring extension length (difference between length of relaxed spring and length of extended spring). Tighten capscrews.

12. Repeat steps 8-9 to verify 10 mm (0.390 in.) spring extension length.

13. Install cables through notch in belt shield.

14. Install drag flap and belt shield with screws.

15. Install battery cover with screws and connect spark plug wire.

16. Start engine and check that transmission is operating properly.

NOTE: Make sure transmission immediately disengages when traction clutch lever is released.

17. If transmission does not disengage when lever is released, reduce spring extension length and check that transmission is operating properly.

Lubricating Drive Shaft Hub Bushings

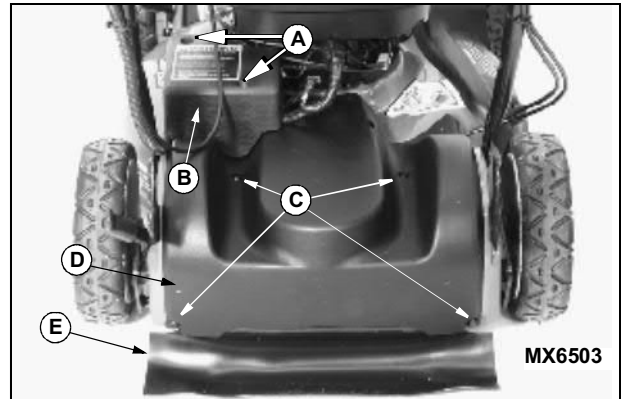

1. Remove screws (A) and battery cover (B).
2. Remove screws (C), belt shield (D), and drag flap (E).

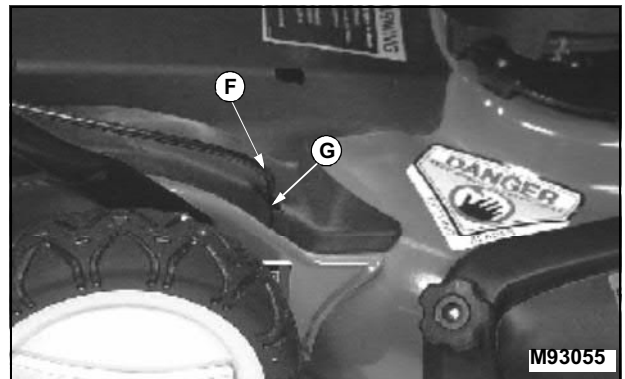

3. Remove control cables (F) from belt shield notch (G).

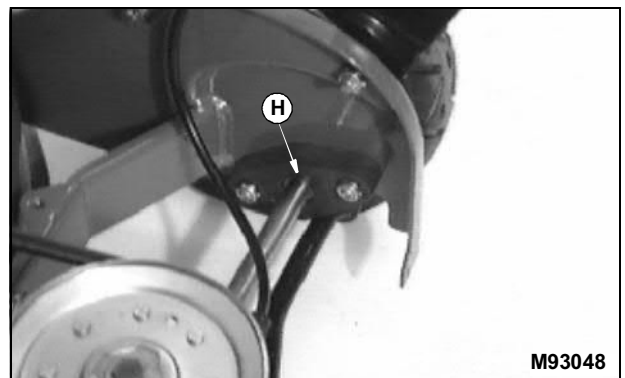

4. Tilt mower slightly to one side. Lubricate driveshaft hub bushing (H) with a few drops of lightweight motor oil. Repeat procedure for other side.
5. Slide control cables (F) into belt shield notch (G).
6. Install drag flap and belt shield with screws.
7. Install battery cover with screws.

SERVICE

Lubricating Mower Axles

1. Tip mower to one side to raise mower wheels slightly off ground. Use wood blocks to keep side of mower raised.

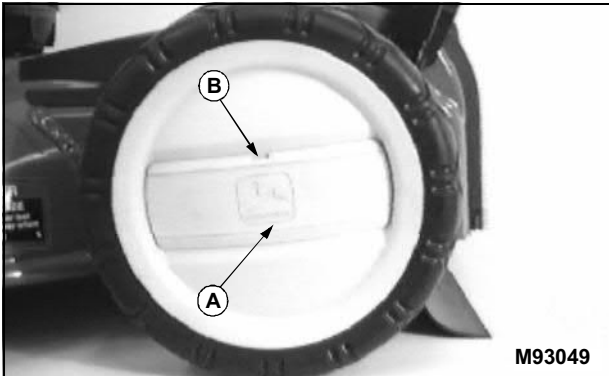

2. Remove plastic hubcap (A) from each wheel.

- Use a screwdriver in slot (B) to pry hubcap from wheel.

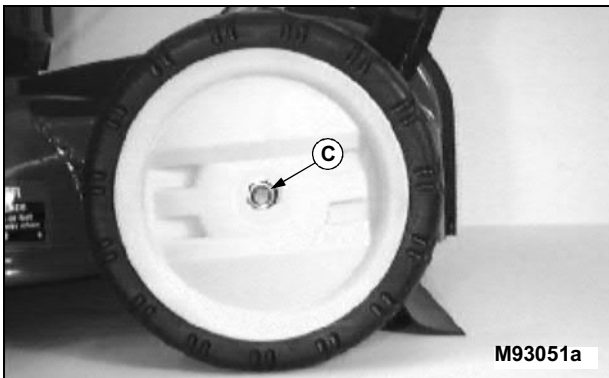

3. Remove locknut (C).

4. Remove wheel from each axle.

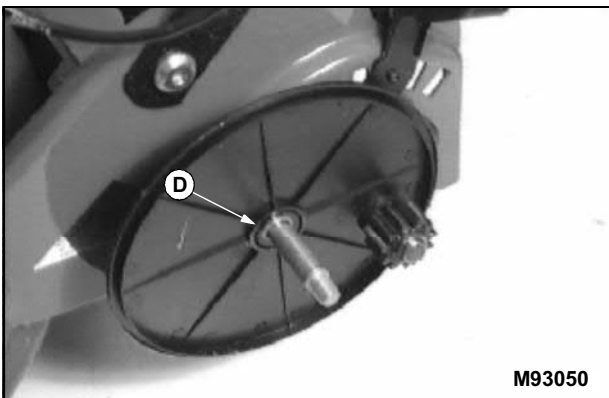

5. Apply light coating of grease to each axle (D).

6. Install wheels, hardware and hubcaps.

7. Lower mower.

8. Repeat procedure for wheels on other side of mower.

Checking and Removing Blade



CAUTION: Avoid injury! Service blade safely:

- Stop engine. Let it cool.
- Disconnect spark plug wire.
- Wear gloves or wrap blade with rag.

IMPORTANT: Avoid damage! To help prevent air cleaner damage and hard starting:

- Turn mower on its left side.

NOTE: Sharpened edges on blade tips must face upward when installing blade.

Checking Blade:

- Replace damaged blade.

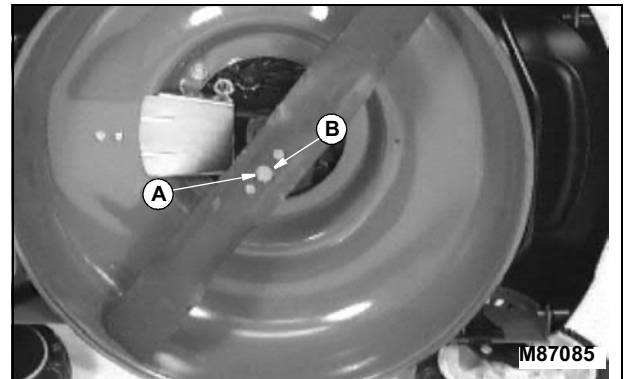

- Tighten bolt (A) to 75 N•m (55 lb-ft).
- Sharpen dull blade. (See Sharpening Blade in this section.)

Removing Blade:

- Remove bolt (A), washer (B), and blade.

Sharpening Blade



CAUTION: Avoid injury! Wear gloves and goggles when sharpening, balancing or installing blade.

- Sharpen blade with grinder, hand file or electric blade sharpener.

SERVICE

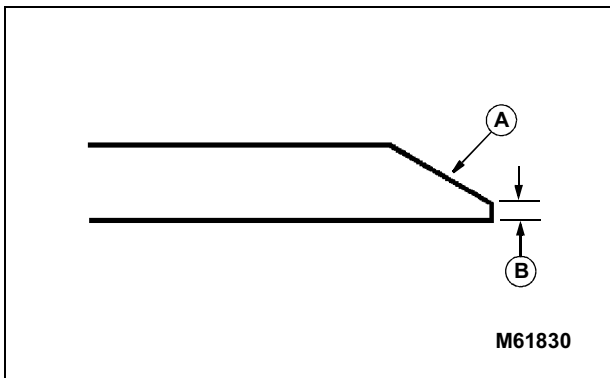

- Keep original bevel (A) when you grind.
- Blade should have 0.40 mm (1/64 in.) cutting edge (B).

IMPORTANT: Avoid damage! Balance blade after you sharpen it. An unbalanced blade may cause excessive vibration.

Balancing and Installing Blade

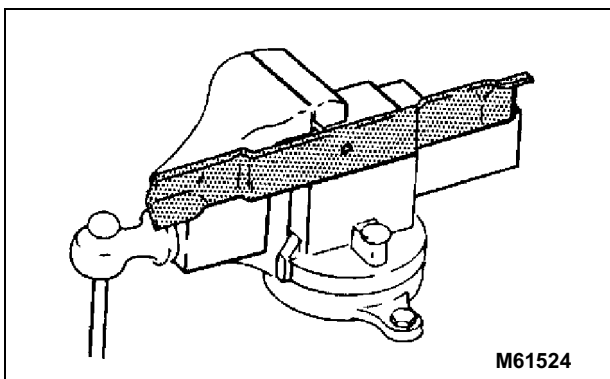

1. Clean blade. Put it on a nail in vise or on a wall. Heavy end of blade will drop. Grind bevel of heavy end. Do not change bevel.
2. Install blade, washers (cup-side against blade), and bolts.
3. Tighten bolts to 75 N•m (55 lb-ft).

Replacing the Fuse

IMPORTANT: Avoid damage! Be sure replacement fuse is proper amperage.

1. Remove screws and battery cover.

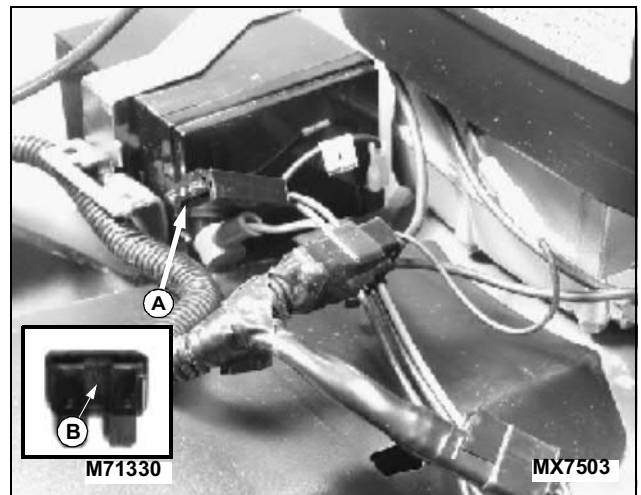

2. Pull fuse (A) out of socket.
3. Check metal clip (B) in fuse window. Discard fuse if clip is broken.
4. Push new fuse into socket.
5. Install battery cover with screws.

Charging the Battery

IMPORTANT: Avoid damage! Use only charger supplied with mower. Other chargers may permanently damage battery.

NOTE: If battery is not used for extended time, you may have to charge it. If battery is not completely discharged, it can be charged by running engine or by using battery charger.

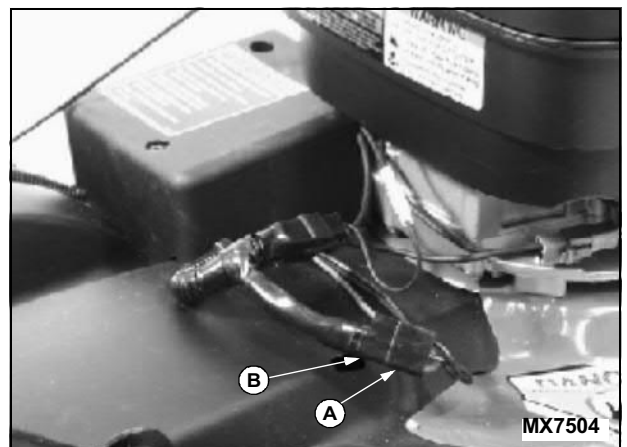

1. Disconnect battery wire connector (A) from engine wire connector (B).

SERVICE

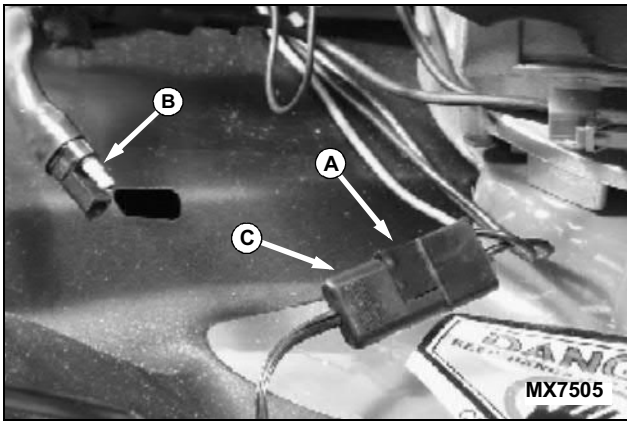

CAUTION: Avoid injury! Help prevent serious injury or death from an electrical shock or electrocution.

- Battery must always have wire connectors and boot properly installed on terminals during installation or removal.
- Never check battery charge by placing a metal object across the terminal post.

2. Connect battery wire connector (A) to battery charger cord connector (C).
3. Plug charger into 110-volt house receptacle. Charge 24-36 hours for a new or discharged battery.
4. Unplug cord from house receptacle, then from battery.
5. Connect battery wire connector to engine wire connector (B).

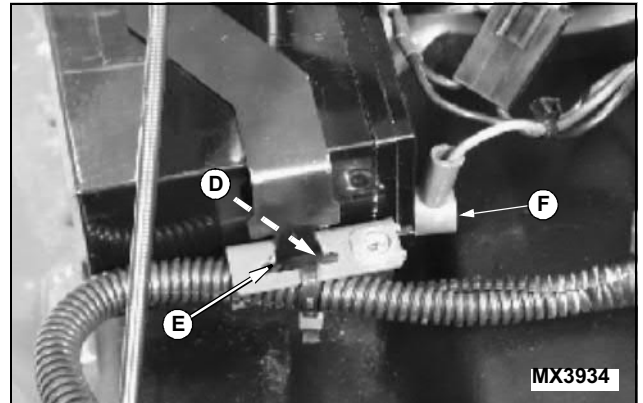

Removing and Installing the Battery

Removing:

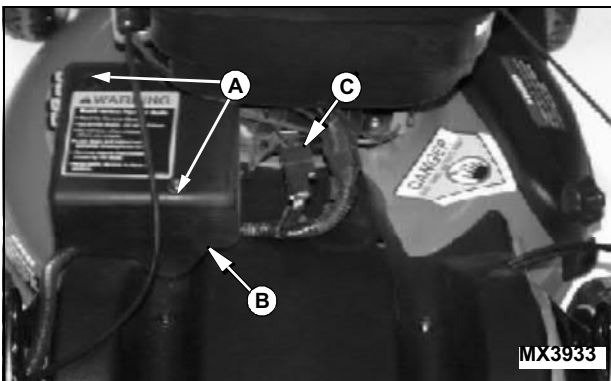

1. Remove two screws (A) and battery cover (B).
2. Disconnect battery wire connector (C) from engine wire connector.

3. Pull the battery retainer tab (D) located under the bracket toward the rear of the mower and up out of slot (E).
4. Slide battery toward center of mower and remove.
5. Disconnect the negative lead from negative terminal.
6. Pull red cover (F) away from positive lead and remove lead from red positive terminal. Retain wire harness for use with new battery.

Installing:

Follow removal steps in reverse order.

SERVICE

Filling Fuel Tank



CAUTION: Avoid injury! Fuel vapors are explosive and flammable:

- Shut engine off before filling fuel tank.
- Do not smoke while handling fuel.
- Keep fuel away from flames or sparks
- Fill fuel tank outdoors or in well ventilated area.
- Clean up spilled fuel immediately.
- Use clean approved non-metal container to prevent static electric discharge.
- Use clean approved plastic funnel without screen or filter to prevent static electric discharge.

IMPORTANT: Avoid damage! Dirt and water in fuel can cause engine damage:

- Clean dirt and debris from the fuel tank opening.
- Use clean, fresh, stabilized fuel.
- Fill the fuel tank at the end of each day's operation to keep condensation out of the fuel tank.
- Use a non-metallic funnel with a plastic mesh strainer when filling the fuel tank or container.

Use regular grade 87 octane unleaded fuel.

Add John Deere fuel stabilizer to fuel before using it in your machine to prevent engine damage due to stale fuel. Follow directions on stabilizer container.

1. Stop engine. If engine is hot let it cool several minutes before you add fuel.
2. Remove grass clippings and other trash from tank area.

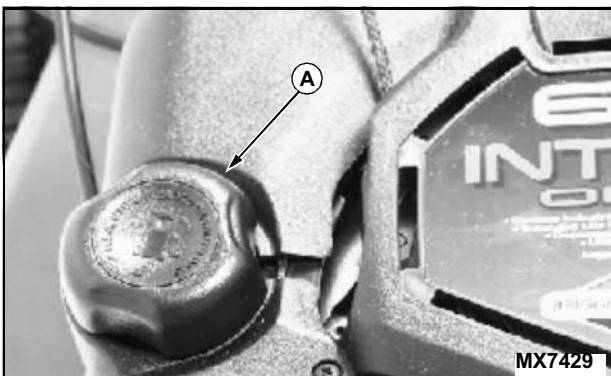

3. Remove fuel cap (A).
4. Fill tank with fresh fuel only to bottom of filler neck.
5. Install fuel cap.

Cleaning Fuel Cap Vents



CAUTION: Avoid injury! Before you remove cap:

- Stop engine. Let it cool.
- Do not smoke.

1. Remove fuel cap.

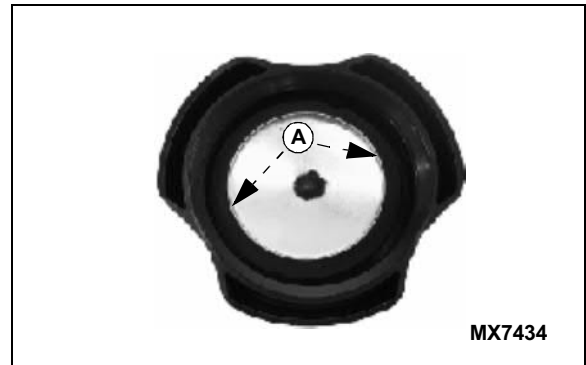

2. Check two vents (A) under metal ring and vent in top, center of cap.
3. Clean cap and vents in nonflammable solvent. Let cap dry.
4. Install cap.

TROUBLESHOOTING

Using Troubleshooting Chart

If you are experiencing a problem that is not listed in this chart, see your authorized John Deere dealer.

When you have checked all the possible causes listed and you are still experiencing the problem, see your authorized John Deere dealer.

IF	CHECK
Engine Will Not Start	<ul style="list-style-type: none"> • Prime engine (Cold - three times, Warm - one or two times) • Fuel tank is empty. • Stale or dirty fuel. • Disconnected or dirty spark plug. • Battery needs to be charged or replaced. • Battery cables connected to wrong terminals.
Engine Starts Hard Or Loses Power	<ul style="list-style-type: none"> • Dirty fuel tank cap vents. • Stale or dirty fuel. • Dirty air cleaner element. • Disconnected or dirty spark plug.
Engine Runs Rough	<ul style="list-style-type: none"> • Carburetor needs to be cleaned. • Disconnected or dirty spark plug. • Dirty air cleaner element. • Dirty cooling fins.
Engine Overheats	<ul style="list-style-type: none"> • Dirty blower housing and cooling fins. • Improper oil level.
Engine Vibrates Too Much	<ul style="list-style-type: none"> • Loose blade bolt. • Blade dull. • Blade improperly balanced. • Bent blade or crankshaft.
Battery Will Not Accept Charge from Battery Charger	<ul style="list-style-type: none"> • Fuse at battery harness is blown. • Battery cables connected to wrong terminals.
Mower Mows Unevenly	<ul style="list-style-type: none"> • Pushing mower too fast. • Mowing too fast around corners and mowing pattern not changed. • Insufficient overlapping of cuts when mowing. • Blade dull or not balanced.
Bagging Chute Plugs	<ul style="list-style-type: none"> • Grass not dry. • Cutting height not raised high enough. • Dirty or full grass bag. • Mowing too fast.

TROUBLESHOOTING

IF	CHECK
Mower Will Not Self-Propel	<ul style="list-style-type: none">• Traction belt broken.• Traction belt jumped off pulley.• Adjust transmission cable.• Traction cable stretched or broken.
Mulched Grass Appearance Is Poor: Clumps, Excessive Clippings, Rough Cut.	<ul style="list-style-type: none">• Grass buildup under deck.• Travel speed too fast.• Blade dull or not balanced.• Cutting height set too low.• Tall grass conditions may require more overlapping of cuts.

STORING MACHINE

Storing Safety



CAUTION: Avoid injury! Engine exhaust fumes can cause sickness or death.

- If it is necessary to run an engine in an enclosed area, use an exhaust pipe extension to remove the fumes. Always try to work in a well ventilated area.
- Do not store mower with fuel in the tank inside a building where fumes may reach an open flame or spark.
- Allow engine to cool before storing in any enclosure.

Preparing Machine for Storage

1. Repair any worn or damaged parts. Replace parts if necessary. Tighten loose hardware.
2. Remove belt shield. Clean belt and transmission area. Do not use water to clean this area. Install shield.

IMPORTANT: Avoid damage! Do not use high pressure spray when cleaning under the deck. High pressure spray may cause damage to clutch and transmission parts.

3. Clean under the deck.
4. Sharpen mower blade.
5. Paint scratched or chipped metal surfaces to prevent rust.
6. Apply light coat of engine oil to pivot and wear points to prevent rust.
7. Lubricate grease points.

Preparing Fuel and Engine For Storage

Fuel:

If you have been using "Stabilized Fuel," add stabilized fuel to tank until the tank is full.

NOTE: Filling the fuel tank reduces the amount of air in the fuel tank and helps reduce deterioration of fuel.

If you are not using "Stabilized Fuel":

1. Park mower in a well-ventilated area.

NOTE: Try to anticipate last time mower will be used for season so very little fuel is left in fuel tank.

2. Start mower and allow to run until it runs out of fuel.

IMPORTANT: Avoid damage! Stale fuel can produce varnish and plug carburetor components and affect engine performance.

- Add fuel conditioner or stabilizer to fresh fuel before filling tank.

3. Mix fresh fuel and fuel stabilizer in separate container. Follow stabilizer instructions for mixing.
4. Fill fuel tank with stabilized fuel.
5. Run engine for a few minutes to allow fuel mixture to circulate through carburetor.

Engine:

Engine storage procedure should be used when machine is not to be used for longer than 60 days.

1. Change engine oil and filter while engine is warm.
2. Service air filter if necessary.
3. Clean debris from engine air intake.
4. Remove spark plug. Put 30 mL (1 oz.) of clean engine oil in cylinders.
5. Install spark plug, but do not connect spark plug wire.
6. Start the engine and run for approximately five seconds to allow oil to be distributed.
7. Clean the engine and engine compartment.

IMPORTANT: Avoid damage! Store the mower in a place where the temperature does not exceed the following range: -15°C - 40°C (5°F - 104°F) to prevent battery damage.

8. Store the mower in a dry, protected place. If vehicle is stored outside, put a waterproof cover over it.

Fold Handles

IMPORTANT: Avoid damage! Prevent damage to mower control cables:

- Do not crimp cables when folding handle bars.
- Do not attempt to fold upper mower handle upward.

1. Remove grass bag and bagging chute if installed.

STORING MACHINE



2. Remove starter handle (A) from rope guide.

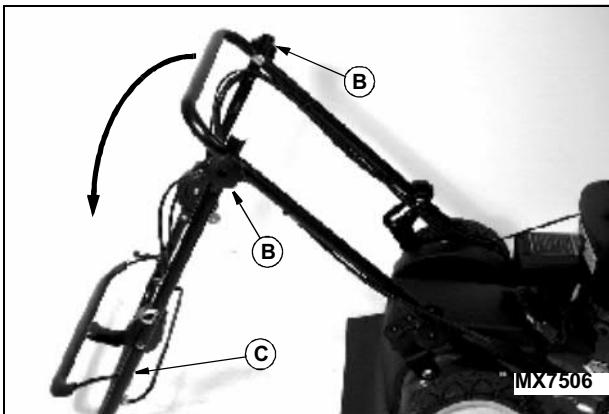

3. Loosen knob (B) on each side to allow upper handle (C) to pivot down.

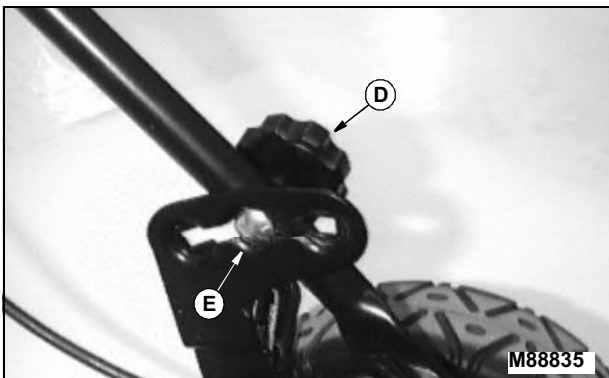

4. Remove knob (D) and carriage bolt (E) from each side.

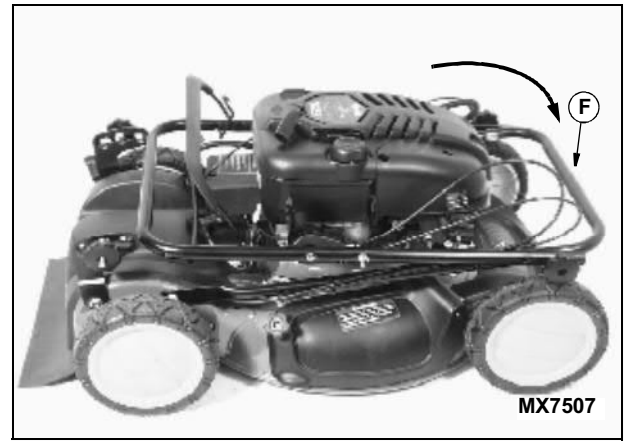

5. Carefully fold lower handle (F) forward. Guide cables inside lower handle. Do not crimp cables.
6. Install carriage bolts and knobs in lower handle.

Removing Mower From Storage

1. Unfold handles. Tighten knobs. Do not crimp cables.
2. Check engine oil level.
3. Connect wire to spark plug.
4. Inspect shields, safety devices and hardware.
5. Lubricate rear axle bushings.
6. Push primer bulb three times to prime engine.

ASSEMBLY

Unfold Handles

IMPORTANT: Avoid damage! Prevent damage to mower control cables when installing handle assembly. Do not pinch or crimp control cables. Control cables must be inside of handle and unrestricted before tightening hardware.

1. Carefully remove mower from shipping carton.



2. Loosen knob (A) on each side of upper handle.
3. Remove knob (B) and carriage bolt from each side.
4. Carefully pull folded handle assembly rearward.

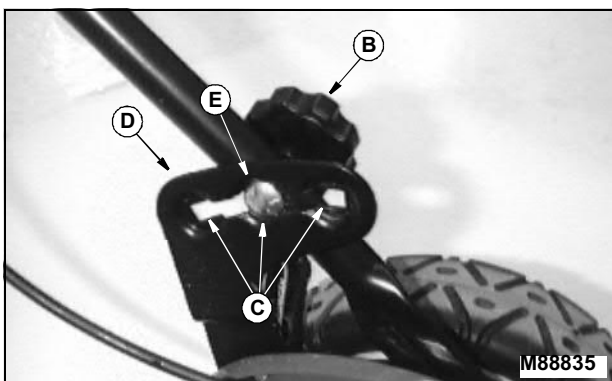

5. Pivot handle to desired height at one of three positions (C) within slotted adjustment bracket (D).
6. Install carriage bolt (E) from inside through hole in bracket (D) and through handle on each side of handle. Use same hole on each side.
7. Install and tighten knob (B) on each bolt. Both handle knobs should be positioned on outside of handles.

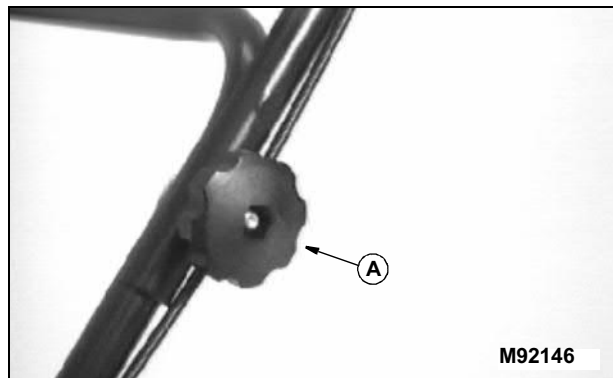

8. Pivot upper portion of handle assembly so it is straight and aligned with lower portion. Hold handle and tighten knob (A) on each side.

Install Starter Rope

NOTE: To make installation of starter rope onto rope guide easier, hold blade control lever against handle while pulling starter rope.

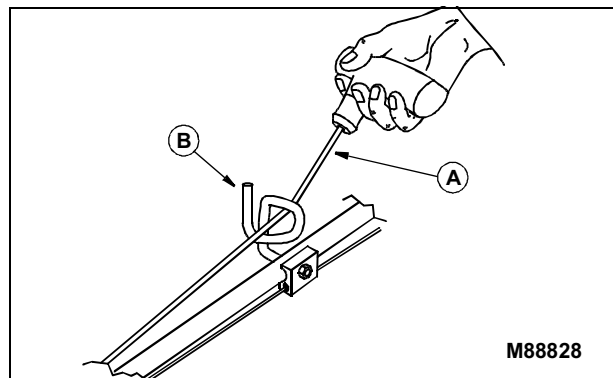

Pull and install starter rope (A) onto rope guide (B) mounted on the right side of the handle.

ASSEMBLY

Charging the Battery

IMPORTANT: Avoid damage! Use only charger supplied with mower. Other chargers may permanently damage battery.

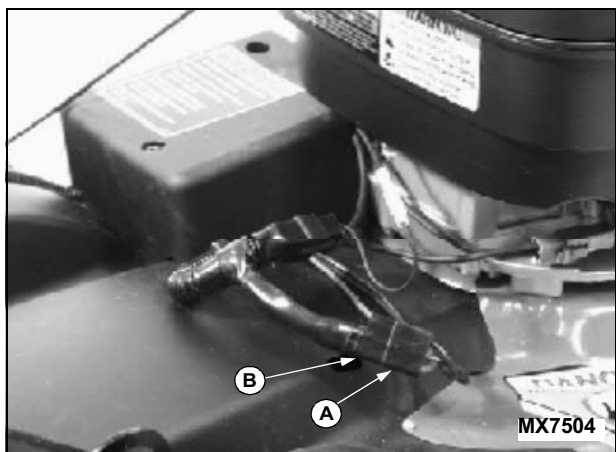

1. Disconnect battery wire connector (A) from engine wire connector (B).

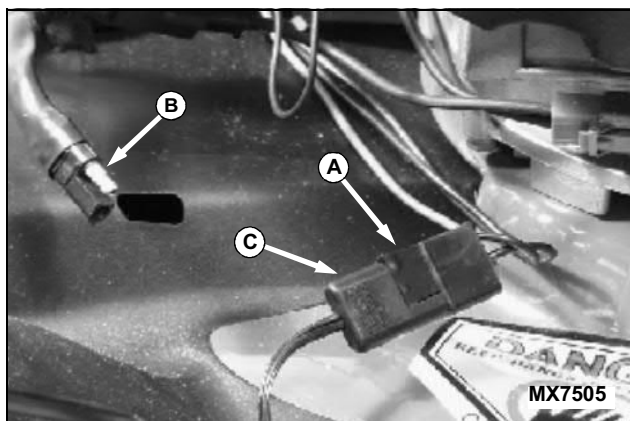

2. Connect battery wire connector (A) to battery charger cord connector (C).
3. Plug charger into 110-volt house receptacle. Charge 24-36 hours for a new or discharged battery.
4. Unplug cord from house receptacle, then from battery.
5. Connect battery wire connector to engine wire connector (B).

Add Engine Oil

IMPORTANT: Avoid damage! Engine is shipped without oil.

You must add oil before running the engine. See Service section for correct oil application.

1. Park mower on level surface and clean area around oil dipstick.

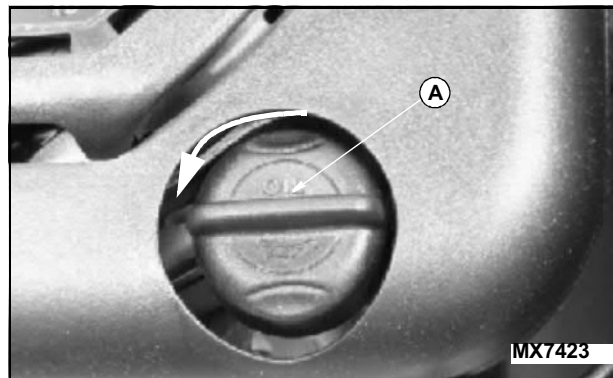

2. Turn oil dipstick (A) 1/4 turn counterclockwise. Remove dipstick.
3. Add 0.47 L (16 oz.) oil through dipstick tube.
4. Check oil level:
 - Install dipstick, turn it clockwise 1/4 turn and tighten it.
 - Remove dipstick.

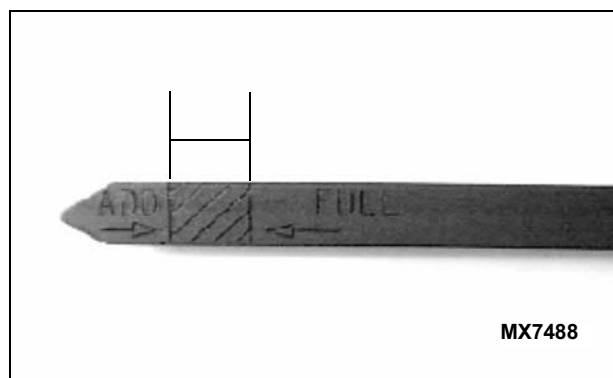

5. Install and tighten dipstick.
 6. Remove "No Oil" tag from top of engine.
- Check oil level: Oil should be between ADD and FULL marks on dipstick. If not, add oil.

Test Mower



CAUTION: Avoid injury! Engine exhaust fumes can cause sickness or death. Run engine only in a ventilated area.

If engine is run in an enclosed area, open doors to bring in outside air.

ASSEMBLY

Manual Start Mode



CAUTION: Avoid injury! When engine is running, blade is turning. Keep hands, feet and clothing away from the blade.



CAUTION: Avoid injury! If blade does not stop within 3 seconds after you release blade stop lever, see your John Deere dealer.

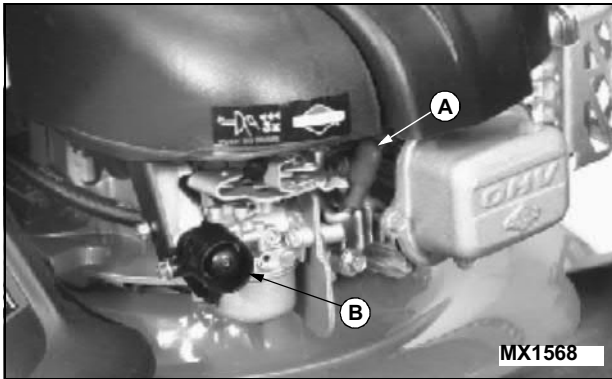

1. Connect spark plug wire (A) to spark plug.
2. Put enough fuel in fuel tank to test mower operation.
3. Press primer bulb (B) three times to prime engine.

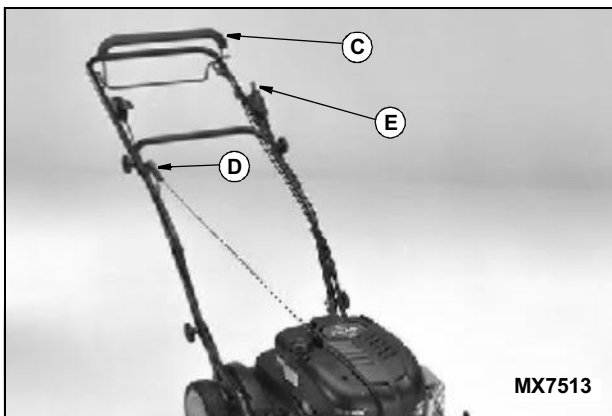

4. Hold blade control lever (C) against handle.
5. Pull starter rope (D) to start engine.
6. Release blade control lever to stop engine.



CAUTION: Avoid injury! If blade does not stop within 3 seconds after you release blade stop lever, see your John Deere dealer.

Electric Start Mode

1. Press primer bulb again if necessary.
2. Hold blade control lever (C) against handle.
3. Turn key (E) to start engine.
4. Release blade control lever to stop engine.

SPECIFICATIONS

Engine

Manufacturer	Briggs & Stratton
Model Series	Intek 121602
Horsepower	4.8 kW (6.5 hp)
Cycle	4
Valve Type	Over Head Valve (OHV)
Choke	Primer Bulb
Displacement	190 cc (11.59 cu in.)
Bore & Stroke	68 x 52 mm (2.64 x 2.04 in.)
Operating Range	3000-3200 rpm
Spark Plug	Champion RC12YC
Spark Plug Gap	0.51 mm (0.02 in.)
Spark Plug Torque	20 N•m (15 lb-ft)
Starter	Recoil
Air Cleaner	Paper Element with Foam Pre-Cleaner

Travel Speed Range

First Gear	3.1 km/h (1.9 mph)
Second Gear	3.9 km/h (2.4 mph)
Third Gear	5.0 km/h (3.1 mph)

Capacities

Fuel	1.5 L (1.6 qt)
Engine Oil	0.47 L (16 oz)

Machine Specifications

Deck Material	Steel
Adjustable Handle	Standard
Rear Grass Bag	Available
Side Discharge Chute	Standard
Mulching	Standard
Mower Blade Bolt Torque	75 N•m (55 lb-ft)
Safety System	Zone Start

Dimensions

Wheel Size	8.75 x 2.25
------------	-------------

SPECIFICATIONS

Mower Weight without Attachments	38.6 kg (85 lb)
Cutting Height Range	2.5-10.2 cm (1-4 in.)
Cutting Width	53.3 cm (21 in.)

Recommended Lubricants

Engine Oil	TORQ-GARD SUPREME® (SAE 30 or SAE 10W-30)
Grease	John Deere MOLY HIGH TEMPERATURE EP GREASE
.....	John Deere HIGH TEMPERATURE EP GREASE
.....	John Deere GREASE GARD™

(Specifications and design subject to change without notice)

WARRANTY

Product Warranty

Product warranty is provided as part of John Deere's support program for customers who operate and maintain their equipment as described in this manual.

Engine related warranties stated in this manual refer only to emissions-related parts and components of your engine. The complete engine warranty, less emission-related parts and components, is provided separately as the "Limited Warranty for New John Deere Commercial & Consumer Equipment".

Limited Warranty For New John Deere Commercial & Consumer Equipment

(U.S. Only)

A. GENERAL PROVISIONS - The warranties described below are provided by John Deere Company ("John Deere") to the original purchasers of new Commercial & Consumer Equipment from John Deere or authorized John Deere dealers. Under these warranties, John Deere will repair or replace, at its option, any covered part which is found to be defective in material or workmanship during the applicable warranty term. Warranty service must be performed by a dealer or service center authorized by John Deere to sell and/or service the type of product involved, which will use only new or remanufactured parts or components furnished by John Deere. Warranty service will be performed without charge to the purchaser for parts or labor. The purchaser will be responsible, however, for any service call and/or transportation of product to and from the dealer's or service center's place of business, for any premium charged for overtime labor requested by the purchaser, and for any service and/or maintenance not directly related to any defect covered under the warranties below.

B. WHAT IS WARRANTED - All parts of any new John Deere product, except tires, radios, and batteries, are warranted for the number of months or operating hours specified below. John Deere Hand Held-Portable products are covered by a separate warranty. Warranty statements required by law covering engine emission-related parts and components are found in the Operator's Manual delivered with the machine.

COMMERCIAL & CONSUMER EQUIPMENT	WARRANTY TERM
1) In Residential (Private Homeowner) Application	24 Months
2) In Any Other Application	12 Months (Sabre by John Deere products - 90 days)
3) Regardless of Application:	
a) COMPACT UTILITY TRACTORS, WIDE AREA MOWERS, FRONT MOWER TRACTOR UNITS (With diesel or 20 HP and above engines), ZTRAK MOWERS (except F620), COMMERCIAL WALK BEHIND MOWERS (30" or larger), and 7-IRON MOWER DECKS,	24 Months
b) Other mower decks, implements, and attachments for the equipment listed in 3a above, and 3d below.	12 Months or 1000 Hours Whichever Comes First
c) SKID STEERS and approved John Deere Skid Steer attachments	12 Months

COMMERCIAL & CONSUMER EQUIPMENT	WARRANTY TERM
d) UTILITY VEHICLES AND F620 ZTRAK MOWERS	12 Months or 1000 Hours Whichever Comes First

Each warranty term begins on the date of product delivery to the purchaser.

C. WHAT IS NOT WARRANTED - JOHN DEERE IS NOT RESPONSIBLE FOR THE FOLLOWING: (1) Used Products; (2) Any product that has been altered or modified in ways not approved by John Deere, including, but not limited to, setting injection pump fuel delivery above John Deere specifications; (3) Depreciation or damage caused by normal wear, lack of reasonable and proper maintenance, failure to follow operating instructions, misuse, lack of proper protection during storage, or accident; (4) Normal maintenance parts and service.

D. SECURING WARRANTY SERVICE - To secure warranty service, the purchaser must (1) report the product defect to an authorized dealer and request repair within the applicable warranty term, (2) present evidence of the warranty start date, and (3) make the product available to the dealer or service center within a reasonable period of time.

E. LIMITATION OF IMPLIED WARRANTIES AND OTHER REMEDIES - COMMERCIAL & CONSUMER EQUIPMENT - To the extent permitted by law, neither John Deere nor any company affiliated with it makes any warranties, representations or promises as to the quality, performance or freedom from defect of the Commercial & Consumer Equipment covered by this warranty. IMPLIED WARRANTIES OF MERCHANTABILITY AND FITNESS FOR A PARTICULAR PURPOSE, TO THE EXTENT APPLICABLE, SHALL BE LIMITED IN DURATION TO THE APPLICABLE PERIOD OF WARRANTY SET FORTH ON THIS PAGE. THE PURCHASER'S ONLY REMEDIES IN CONNECTION WITH THE BREACH OR PERFORMANCE OF ANY WARRANTY ON THE JOHN DEERE COMMERCIAL & CONSUMER EQUIPMENT ARE THOSE SET FORTH ON THIS PAGE. IN NO EVENT WILL THE DEALER, JOHN DEERE OR ANY COMPANY AFFILIATED WITH JOHN DEERE BE LIABLE FOR INCIDENTAL OR CONSEQUENTIAL DAMAGES. (Note: Some states do not allow limitations on how long an implied warranty lasts or the exclusion or limitation of incidental or consequential damages so the above limitations and exclusions may not apply to you.) This warranty gives you specific legal rights, and you may also have other rights which vary from state to state.

F. NO DEALER WARRANTY - THE SELLING DEALER MAKES NO WARRANTY OF ITS OWN AND THE DEALER HAS NO AUTHORITY TO MAKE ANY REPRESENTATION OR PROMISE ON BEHALF OF JOHN DEERE, OR TO MODIFY THE TERMS OR LIMITATIONS OF THIS WARRANTY IN ANY WAY.

G. If further information is desired, contact your selling dealer.

Limited Warranty For New John Deere Commercial & Consumer Equipment

(Canada Only)

A. GENERAL PROVISIONS - The warranties described below are provided by John Deere Limited, 295 Hunter Road, P.O. Box 1000, Grimsby, Ontario, L3M 4H5 ("John Deere") to the original purchasers of new Commercial & Consumer Equipment ("Equipment") purchased from John Deere or authorized John Deere dealers. Under these warranties, John Deere will, unless otherwise required by law, repair or replace, at its option, any part covered under these warranties which is found to be defective in material or workmanship during the applicable warranty term. Warranty service must be performed by a dealer or sales service centre authorized by John Deere to sell and/or service the Equipment involved

WARRANTY

(the "authorized dealer"). The authorized dealer will use only new or remanufactured parts or components furnished or approved by John Deere. Warranty service will be performed without charge to the purchaser for parts or labour. However the purchaser will be responsible for any service call and/or transportation of Equipment to and from the authorized dealer's place of business, except where prohibited by law, and for any premium charged for overtime labour requested by the purchaser, and for any service and/or maintenance not directly related to any defect covered under these warranties. These warranties are transferable, provided the purchaser trades the Equipment to an authorized dealer and John Deere approves the warranty transfer.

B. WHAT IS WARRANTED - Subject to paragraph C, all parts of any new John Deere Equipment, except tires, radios, and batteries (which are warranted under separate warranty documents provided with each product), are warranted for the number of months or operating hours specified below. John Deere Hand Held-Portable products are covered by a separate warranty. Warranty statements covering engine emission-related parts and components are found in the Operator's Manual delivered with the Equipment.

COMMERCIAL & CONSUMER EQUIPMENT	WARRANTY TERM
1) IN RESIDENTIAL (Private Homeowner) APPLICATION	24 Months
2) IN ANY OTHER APPLICATION	12 Months
3) Regardless of Application: COMPACT UTILITY TRACTORS, WIDE AREA MOWERS, FRONT MOWER TRACTOR UNITS (With diesel or 20 HP and above engines), ZTRAK MOWERS (except F620), COMMERCIAL WALK BEHIND MOWERS (30" or larger), and 7-IRON MOWER DECKS.	24 Months
4) Regardless of Application: SKID STEERS AND APPROVED JOHN DEERE SKID STEER ATTACHMENTS	12 Months
5) Regardless of Application: UTILITY VEHICLES AND F620 ZTRAK MOWERS, other mower decks, implements, and attachments for the equipment listed in 3) and 5).	12 Months or 1,000 Hours Whichever Comes First
6) SABRE by JOHN DEERE PRODUCTS	Residential (Private Homeowner) application - 24 months. In any other application - 90 Days

Each warranty term begins on the date of delivery of the Equipment to the Purchaser.

C. WHAT IS NOT WARRANTED - Pursuant to the terms of these warranties, JOHN DEERE IS NOT RESPONSIBLE FOR THE FOLLOWING: (1) Used Equipment (unless it is specifically covered by separate warranty documents); (2) Any Equipment that has been altered or modified in ways not approved by John Deere, including, but not limited to, setting injection pump fuel delivery above John Deere specifications; (3) Depreciation or damage caused by normal wear, lack of reasonable and proper maintenance, failure to follow operating instructions, misuse, lack of proper protection during storage, vandalism, the elements or collision or accident; (4) Normal maintenance parts or service; (5) Batteries, radios and tires.

D. SECURING WARRANTY SERVICE - To secure warranty service the purchaser must, (1) report the Equipment defect to an authorized dealer and request repair or replacement within the applicable warranty term; (2) present evidence of the warranty start date; and, (3) make the Equipment available to the authorized dealer within a reasonable period of time.

E. REPRESENTATION, CONDITION AND IMPLIED WARRANTY EXCLUSION - THERE ARE NO REPRESENTATIONS, CONDITIONS OR WARRANTIES OTHER THAN THOSE LISTED ABOVE. THIS EXCLUSION INCLUDES FUNDAMENTAL TERMS, REPRESENTATIONS, CONDITIONS AND WARRANTIES WHICH MAY BE EXPRESSED OR IMPLIED, VERBAL OR OTHERWISE, INCLUDING IMPLIED OR STATUTORY CONDITIONS OR WARRANTIES OF MERCHANTABILITY AND FITNESS, WHETHER PURSUANT TO THE SALE OF GOODS ACT OR ANY OTHER STATUTE OF ANY PROVINCE OR OTHERWISE, EXCEPT WHERE SUCH IMPLIED OR STATUTORY CONDITIONS OR WARRANTIES MAY NOT BE EXCLUDED BY LAW.

F. REMEDIES EXCLUSIVE - THE ONLY REMEDIES THE PURCHASER HAS IN CONNECTION WITH THE BREACH OR PERFORMANCE OF ANY WARRANTY ON THE EQUIPMENT ARE THOSE SET FORTH IN THIS WARRANTY, EXCEPT FOR THOSE REMEDIES PROVIDED BY LAW WHICH MAY NOT BE EXCLUDED. IN NO EVENT WILL AN AUTHORIZED DEALER, JOHN DEERE OR ANY COMPANY AFFILIATED WITH JOHN DEERE, BE LIABLE FOR INCIDENTAL OR CONSEQUENTIAL DAMAGES OR INJURIES, INCLUDING BUT NOT LIMITED TO, LOSS OF PROFITS, RENTAL OF SUBSTITUTE EQUIPMENT, OTHER COMMERCIAL LOSS, OR BE LIABLE FOR DAMAGES SUFFERED BY THE PURCHASER AS A RESULT OF FUNDAMENTAL BREACHES OF CONTRACT OR BREACHES OF FUNDAMENTAL TERMS. THE LIMITATION OF LIABILITY CONTAINED IN THIS PARAGRAPH SHALL ONLY BE EFFECTIVE TO THE EXTENT PERMITTED BY LAW.

G. PURCHASE ORDER REQUIRED - John Deere shall have no obligation under these warranties unless a Purchase Order has been signed by both the purchaser and an authorized dealer. In addition, a Product Warranty Registration must be on file at John Deere and include:

1. the purchaser's complete name and address;
2. a full description of the Equipment, including the complete product identification number; and,
3. date of delivery of the Equipment to the purchaser.

H. NO DEALER WARRANTY - Except for conditions or warranties which may not be excluded by law, the selling Dealer makes no warranty of its own on any item warranted by John Deere, and makes no warranty on other items unless it delivers to the purchaser a separate written warranty document specifically warranting the item. THE SELLING DEALER HAS NO AUTHORITY TO MAKE ANY REPRESENTATION OR PROMISE ON BEHALF OF JOHN DEERE OR TO MODIFY THE TERMS OR LIMITATIONS OF THIS WARRANTY IN ANY WAY.

John Deere, Federal and California Emission Control System Warranty (Small Off-Road Gas Engines)

Your Warranty Rights and Obligations

The United States Environmental Protection Agency (EPA), the California Air Resources Board (CARB) and John Deere are pleased to explain the emission control system warranty on your 1995 or later small off-road equipment engine. In California, 1995 and later small off-road equipment engines must be designed, built and equipped to meet the State's stringent anti-smog standards. In other states, 1997 and later model year equipment engines must be designed, built and equipped to meet the U.S. EPA regulations for small non-road, spark ignition engines. John Deere must warrant the emission control system on your small off-road

WARRANTY

equipment engine for the periods of time listed below provided there has been no abuse, neglect or improper maintenance of your small off-road equipment engine.

Your emission control system may include parts such as the carburetor, fuel-injection system and ignition system. Also included may be connectors and other emission related assemblies.

Where a warrantable condition exists, John Deere will repair your small off-road equipment engine at no cost to you including diagnosis, parts and labor.

John Deere Emission Control System Warranty Coverage

In California, 1995 and later small off-road equipment engines are warranted relative to emission control parts for two years. In other states, 1997 and later model year equipment engines are warranted relative to emission control parts for two years. If any emission related part on your engine is defective, the part will be repaired or replaced by John Deere.

Owner's Warranty Responsibilities

As the small off-road equipment engine owner, you are responsible for the performance of the required maintenance listed in your owner's manual. John Deere recommends that you retain all receipts covering maintenance on your small off-road equipment engine, but John Deere cannot deny warranty solely for lack of receipts or for your failure to ensure the performance of all scheduled maintenance.

As the small off-road equipment engine owner, you should however be aware that John Deere may deny you warranty coverage if your small off-road equipment engine or a part has failed due to abuse, neglect, improper maintenance or unapproved modifications.

You are responsible for presenting your small off-road equipment engine to an authorized John Deere Commercial and Consumer Equipment Retailer as soon as a problem exists. The warranty repairs should be completed in a reasonable amount of time, not to exceed 30 days.

If you have any questions regarding your warranty rights and responsibilities, you should contact your John Deere Commercial and Consumer Equipment Retailer, or the John Deere Customer Communications Center at 1-800-537-8233.

Length Of Warranty Coverage

John Deere warrants to the initial owner and each subsequent purchaser that the small off-road equipment engine is:

- Designed, built and equipped so as to conform with all applicable regulations adopted by the California Air Resources Board (CARB) for 1995 and later equipment engines, and all applicable regulations of the United States Environmental Protection Agency (EPA) for 1997 and later equipment engines; and
- Free from defects in materials and workmanship which can cause the failure of an emission warranted part for a period of two years after the engine is delivered to the initial retail purchaser. John Deere is liable for damages to other engine components caused by the failure of a warranted part during the warranty period. If any emission related part on your engine is defective, the part will be repaired or replaced by John Deere.

Warranted Parts

Coverage under this warranty extends only to the parts listed below (the emission control system parts) to the extent these parts were present on the engine purchased.

Fuel Metering System:

- Carburetor and internal parts (or fuel injection system).
- Air/fuel ratio feedback and control system.
- Cold start enrichment system.

Air Induction System:

- Air Cleaner
- Intake manifold.

Ignition System:

- Spark plugs.
- Magneto or electronic ignition system.
- Spark advance/retard system.

Catalyst System:

- Exhaust manifold.

Miscellaneous Items Used in Above Systems

- Vacuum and temperature switches.
- Electronic controls.
- Hoses, belts, connectors and assemblies.

Since emission related parts may vary slightly from model to model, certain models may not contain all of these parts and certain models may contain functionally equivalent parts.

Warranty Service And Charges

Warranty service shall be provided during customary business hours at any authorized John Deere Commercial and Consumer Equipment Retailer located within the United States of America. Repair or replacement of any warranted part will be performed at no charge to the owner, including diagnostic labor which leads to the determination that a warranted part is defective, if the diagnostic work is performed at an authorized John Deere Commercial and Consumer Equipment Retailer. Any parts replaced under this warranty shall become the property of John Deere.

Maintenance Warranty Coverage

- Any warranted part that is not scheduled for replacement as required maintenance must be warranted as to defects for the warranty period. Any such part repaired or replaced under the warranty must be warranted for the remaining warranty period.
- Any warranted part that is scheduled only for regular inspection to the effect of "repair or replace as necessary" must be warranted as to defects for the warranty period. Any such part repaired or replaced under the warranty must be warranted for the remaining warranty period.
- Any warranted part which is scheduled for replacement as required maintenance must be warranted as to defects only for the period of time up to the first scheduled replacement for that part. Any such part repaired or replaced under the warranty must be warranted for the remainder of the period prior to the first scheduled replacement point for that part.
- Normal maintenance, replacement or repair of emission control devices and systems, which are being done at the customer's expense, may be performed by any repair establishment or individual; however, warranty repairs must be performed by an authorized John Deere Commercial and Consumer Equipment Retailer.
- Any replacement part that is equivalent in performance and durability may be used in the performance of any non-warranty maintenance or repairs, and shall not reduce the warranty obligations of John Deere.

Consequential Warranty Coverage

Warranty coverage shall extend to the failure of any engine components caused by the failure of any warranted part still under warranty.

Limitations

This Emission Control System Warranty shall NOT cover any of the following:

WARRANTY

a) Repair or replacement required as a result of (i) misuse or neglect, (ii) improper maintenance or unapproved modifications, (iii) repairs improperly performed or replacements improperly installed, (iv) use of replacement parts or accessories not conforming to John Deere specifications which adversely affect performance and/or durability, (v) alterations or modifications not recommended or approved in writing by John Deere.

b) Replacement parts, other services and adjustments necessary for normal maintenance.

c) Transportation to and from the John Deere Commercial and Consumer Equipment Retailer, or service calls made by the Retailer.

Limited Liability

a) The liability of John Deere under this Emission Control System Warranty is limited solely to the remedying of defects in materials or workmanship. This warranty does not cover inconvenience or loss of use of the small off-road equipment engine or transportation of the engine to or from the John Deere Commercial And Consumer Equipment Retailer. JOHN DEERE SHALL NOT BE LIABLE FOR ANY OTHER EXPENSE, LOSS, OR DAMAGE, WHETHER DIRECT, INCIDENTAL, CONSEQUENTIAL (EXCEPT AS LISTED ABOVE UNDER "COVERAGE") OR EXEMPLARY ARISING IN CONNECTION WITH THE SALE OR USE OF OR INABILITY TO USE THE SMALL OFF-ROAD EQUIPMENT ENGINE FOR ANY OTHER PURPOSE.

b) NO EXPRESS EMISSION CONTROL SYSTEM WARRANTY IS GIVEN BY JOHN DEERE WITH RESPECT TO THE ENGINE EXCEPT AS SPECIFICALLY SET FORTH IN THIS DOCUMENT. ANY EMISSION CONTROL SYSTEM WARRANTY IMPLIED BY LAW, INCLUDING ANY WARRANTY OF MERCHANTABILITY OR FITNESS FOR A PARTICULAR PURPOSE, IS EXPRESSLY LIMITED TO THE EMISSION CONTROL SYSTEM WARRANTY TERMS SET FORTH IN THIS DOCUMENT.

c) No dealer is authorized to modify this Federal, California and John Deere Emission Control System Warranty.

Tire Warranty

John Deere warranty applies for tires available through the John Deere parts system. For tires not available through the John Deere parts system, the tire manufacturer's warranty applicable to your machine may not apply outside the U.S. (See your John Deere dealer for specific information.)

Limited Battery Warranty

NOTE: Applicable in North America only. For complete machine warranty, reference a copy of the John Deere warranty statement. Contact your John Deere dealer to obtain a copy.

TO SECURE WARRANTY SERVICE

The purchaser must request warranty service from a John Deere dealer authorized to sell John Deere batteries, and present the battery to the dealer with the top cover plate codes intact.

FREE REPLACEMENT

Any new battery which becomes unserviceable (not merely discharged) due to defects in material or workmanship within 90 days of purchase will be replaced free of charge. Installation costs will be covered by warranty if (1) the unserviceable battery was installed by a John Deere factory or dealer, (2) failure occurs within 90 days of purchase, and (3) the replacement battery is installed by a John Deere dealer.

PRO RATA ADJUSTMENT

Any new battery which becomes unserviceable (not merely discharged) due to defects in material or workmanship more than 90 days after purchase, but before the expiration of the applicable adjustment period, will be replaced upon payment of the battery's current list price less a pro rata credit for unused months of service. The applicable adjustment period is determined from the Warranty Code printed at the top of the battery and chart below. Installation costs are not covered by warranty after 90 days from the date of purchase.

THIS WARRANTY DOES NOT COVER

A. Breakage of the container, cover, or terminals.

B. Depreciation or damage caused by lack of reasonable and necessary maintenance or by improper maintenance.

C. Transportation, mailing, or service call charges for warranty service.

LIMITATION OF IMPLIED WARRANTIES AND PURCHASER'S REMEDIES

To the extent permitted by law, neither John Deere nor any company affiliated with it makes any warranties, representations, or promises as to the quality, performance or freedom from defect of the products covered by this warranty. IMPLIED WARRANTIES OF MERCHANTABILITY AND FITNESS FOR A PARTICULAR PURPOSE, TO THE EXTENT APPLICABLE, SHALL BE LIMITED IN DURATION TO THE APPLICABLE ADJUSTMENT PERIOD SET FORTH HERE. THE PURCHASER'S ONLY REMEDIES IN CONNECTION WITH THE BREACH OR PERFORMANCE OF ANY WARRANTY ON JOHN DEERE BATTERIES ARE THOSE SET FORTH HERE. IN NO EVENT WILL THE DEALER, JOHN DEERE OR ANY COMPANY AFFILIATED WITH JOHN DEERE BE LIABLE FOR INCIDENTAL OR CONSEQUENTIAL DAMAGES. (Note: Some states do not allow limitations on how long an implied warranty lasts or the exclusion or limitation of incidental or consequential damages. So these limitations and exclusions may not apply to you.) This warranty gives you specific legal rights, and you may also have some rights which vary from state to state.

NO DEALER WARRANTY

The selling dealer makes no warranty of its own and the dealer has no authority to make any representation or promise on behalf of John Deere, or to modify the terms or limitations of this warranty in any way.

PRO RATA MONTHS OF ADJUSTMENT

NOTE: If your battery is not labeled with a warranty code, it is a warranty code "B".

Warranty Code	Warranty Period
A	40 Months
B	36 Months
C	24 Months

INDEX

A

Axles, Lubricate Mower 22

B

Battery, Charging 23, 31
Battery, Removing and Installing 24
Belt and Transmission Area, Cleaning 17
Belt, Checking and Replacing 18
Belt, Drive, Checking and Replacing 18
Blade, Balancing and Installing 23
Blade, Checking and Removing 22
Blade, Selecting Proper 11
Blade, Sharpening 22
Blade/EngineControl Lever, Testing 8
Bushings, Lubricate Drive Shaft Hub 21

C

Capacities 33
Carburetor, Adjusting 14
Certification Label 3
Controls 7
Cutting Height, Adjusting 7

D

Discharge Chute, Using Side 11

E

Element, Checking and Cleaning Air Cleaner 16
Emission Compliance Period 3
Emission Control System Certification Label 3
Engine Cooling Fins, Cleaning 17
Engine Oil 14
Engine Warranty Maintenance Statement 14
Engine, Add Oil 31
Engine, Specifications 33
Engine, Starting 9
Engine, Stopping 10

F

Fuel Cap Vent, Cleaning 25
Fuel Tank, Filling 25
Fuse, Replacing 23

H

Handle Height, Adjusting 7
Handles, Fold 28

I

Interval Chart for Service 13

L

Labels, Safety 1
Literature, Service 12
Lubricants 34

M

Machine, Operating 10

O

Oil Level, Checking Engine 14
Oil, Add Engine 31
Oil, Changing 15
Oil, Engine 14

P

Parts Catalog 12
Parts, Replacement 12

S

Safety Systems, Testing 8
Safety, Maintenance 5
Safety, Operating 4
Safety-Alert Symbol 1
Service Intervals 13
Service Literature 12
Service Record 41
Spark Plug, Cleaning and Gapping 17
Specifications, Engine 33
Speed, Selecting Travel 11

T

Technical Manual 12
Transmission Cable, Adjusting 20
Troubleshooting Chart 26

W

Warranty Maintenance Statement, Engine 14
Warranty, Product 35
Waste Products, Handling 6

NOTES

NOTES

NOTES

JOHN DEERE QUALITY STATEMENT

John Deere Quality



John Deere equipment is more than just a purchase, it's an investment in quality. That quality goes beyond our equipment to your John Deere dealer's parts and service support. This support is needed to keep you a satisfied customer.

That's why John Deere has initiated a process to handle your questions or problems, should they arise. The following three steps will help guide you through the process.

Step 1

Refer to your operator's manual

- A. It has many illustrations and detailed information on the safe and proper operation of your equipment.
- B. It gives troubleshooting procedures, and specification information.
- C. It gives ordering information for parts catalogs, service and technical manuals.
- D. If your questions are not answered in the operator's manual, then go to Step 2.

Step 2

Contact your dealer

- A. Your John Deere dealer has the responsibility, authority, and ability to answer questions, resolve problems, and fulfill your parts and service needs.
- B. First, discuss your questions or problems with your dealer's trained parts and service staff.
- C. If the parts and service people are unable to resolve your problem, see the dealership manager or owner.
- D. If your questions or problems are not resolved by the dealer, then go to Step 3.

Step 3

Call the John Deere Customer Communications Center

- A. Your John Deere dealer is the most efficient source in addressing any concern, but if you are not able to resolve your problem after checking your operator's manual and contacting your dealer, call the Customer Communications Center.
- B. For prompt, effective service, please have the following ready before you call:
 - The name of the dealer with whom you've been working.
 - Your equipment model number.
 - Number of hours on machine (if applicable).
 - Your 13-digit serial number which you recorded on the inside front cover of this manual.
 - If the problem is with an attachment, your attachment identification number.
- C. Then call 1-800-537-8233 and our advisor will work with your dealer to investigate your concern.

SERVICE RECORD

Record Service Dates

Oil Change	Lubricate Machine	Air Cleaner Element Clean/Replace