

JOHN DEERE
WORLDWIDE COMMERCIAL & CONSUMER
EQUIPMENT DIVISION

Compact Utility Tractor
3120, 3320, 3520, 3720

SN (310001-), (330001-), (358001-), (380001-)

OMLVU19809 L8

OPERATOR'S MANUAL

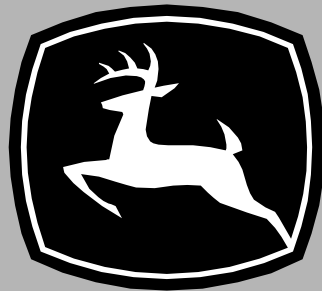

JOHN DEERE

⚠ WARNING: Diesel engine exhaust and some of its constituents are known to the State of California to cause cancer, birth defects, and other reproductive harm.

California Proposition 65 Warning

North American Version
Litho in U.S.A.

INTRODUCTION

Thank You for Purchasing a John Deere Product

We appreciate having you as a customer and wish you many years of safe and satisfied use of your machine.

Using Your Operator's Manual

This manual is an important part of your machine and should remain with the machine when you sell it.

Reading your operator's manual will help you and others avoid personal injury or damage to the machine. Information given in this manual will provide the operator with the safest and most effective use of the machine. Knowing how to operate this machine safely and correctly will allow you to train others who may operate this machine.

If you have an attachment, use the safety and operating information in the attachment operator's manual along with the machine operator's manual to operate the attachment safely and correctly.

This manual and safety signs on your machine may also be available in other languages (see your authorized dealer to order).

Sections in your operator's manual are placed in a specific order to help you understand all the safety messages and learn the controls so you can operate this machine safely. You can also use this manual to answer any specific operating or servicing questions. A convenient index located at the end of this book will help you to find needed information quickly.

The machine shown in this manual may differ slightly from your machine, but will be similar enough to help you understand our instructions.

RIGHT-HAND and LEFT-HAND sides are determined by facing in the direction the machine will travel when going forward. When you see a broken line (-----), the item referred to is hidden from view.

Before delivering this machine, your dealer performed a predelivery inspection to ensure best performance.

Special Messages

Your manual contains special messages to bring attention to potential safety concerns, machine damage as well as helpful operating and servicing information. Please read all the information carefully to avoid injury and machine damage.



CAUTION: Avoid injury! This symbol and text highlight potential hazards or death to the operator or bystanders that may occur if the hazards or procedures are ignored.

IMPORTANT: Avoid damage! This text is used to tell the operator of actions or conditions that might result in damage to the machine.

NOTE: General information is given throughout the manual that may help the operator in the operation or service of the machine.

Attachments for Your Machine

There's a John Deere attachment or kit to make your new machine perform more tasks or be more versatile, whether your machine is a lawn tractor or compact utility tractor or a utility vehicle.

You can check out the entire line of attachments for your machine at JohnDeere.com or ask your John Deere dealer. From aerators to electric lift kits to tillers, there's a John Deere attachment or kit to fill every need.

PRODUCT IDENTIFICATION

Record Identification Numbers

Compact Utility Tractor

3120 PIN (310001-)

3320 PIN (330001-)

3520 PIN (358001-)

3720 PIN (380001-)

If you need to contact an Authorized Service Center for information on servicing, always provide the product model and identification numbers.

You will need to locate the identifications numbers for the product. Record the information in the spaces provided below.

DATE OF PURCHASE:

DEALER NAME:

DEALER PHONE:

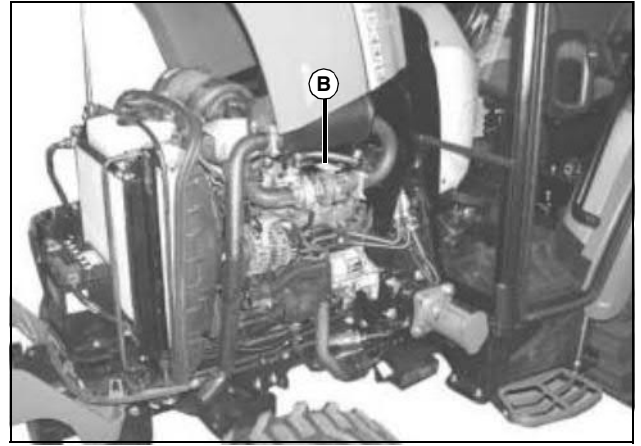

MX35851

ENGINE SERIAL NUMBER (B):

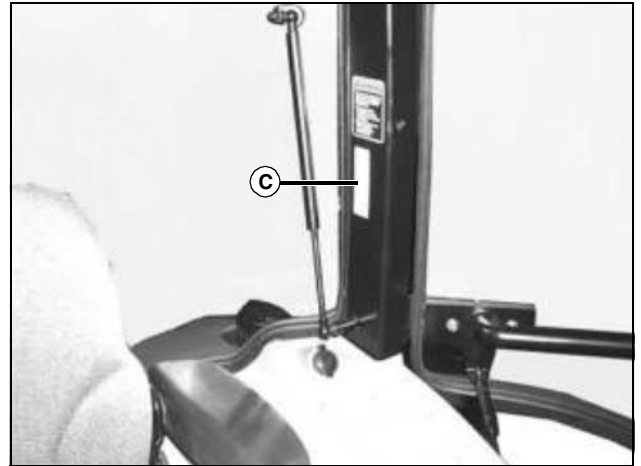

MX35852

CAB SERIAL NUMBER (C):



MX35836

PRODUCT IDENTIFICATION NUMBER (A):

TABLE OF CONTENTS

Safety Labels	5
Safety Labels	7
Safety	11
Operating - Controls	16
Operating - Machine	20
Replacement Parts	53
Service Intervals	54
Service Lubrication	56
Service Engine	57
Service Transmission	70
Service Steering & Brakes	74
Service Electrical	76
Service Miscellaneous	84
Troubleshooting	92
Storage	101
Specifications	102
Warranty	110
Index	113

All information, illustrations and specifications in this manual are based on the latest information at the time of publication. The right is reserved to make changes at any time without notice.

COPYRIGHT© 2008
Deere & Co.
John Deere Worldwide Commercial and
Consumer Equipment Division
All rights reserved
Previous Editions
COPYRIGHT© 2007

OMLVU19809 L8 - English

SAFETY LABELS

Safety Label Location

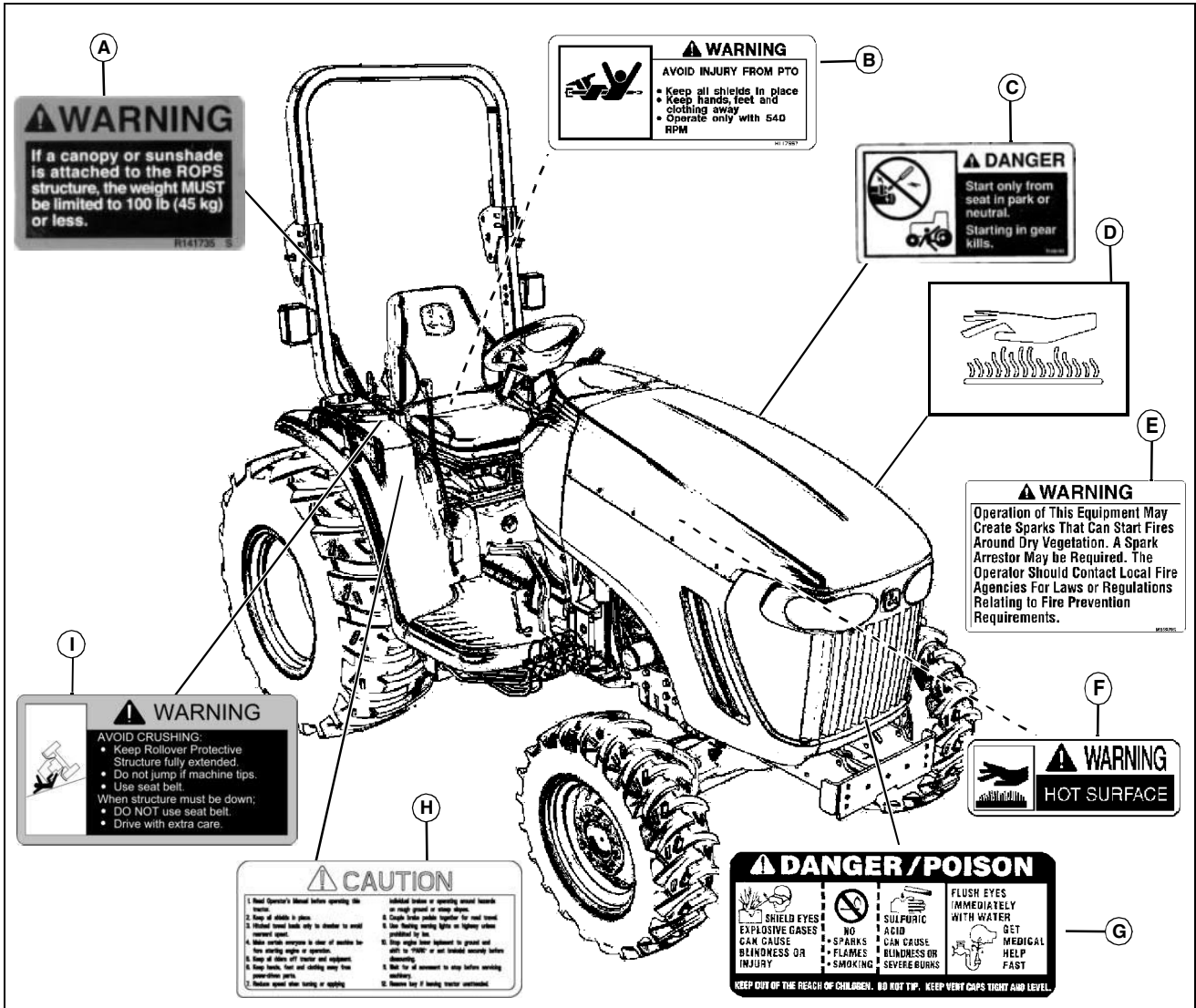

MX41877

Picture Note: Use label number listed in table below to locate complete text of safety label message following this illustration.

- A - WARNING R141735
- B - WARNING M117557
- C - DANGER T146195
- D - CAUTION HOT SURFACE (embossed on muffler)
- E - WARNING M159705
- F - WARNING M117554
- G - DANGER/POISON M88249
- H - CAUTION LVU10708
- I - WARNING LVU10709

SAFETY LABELS

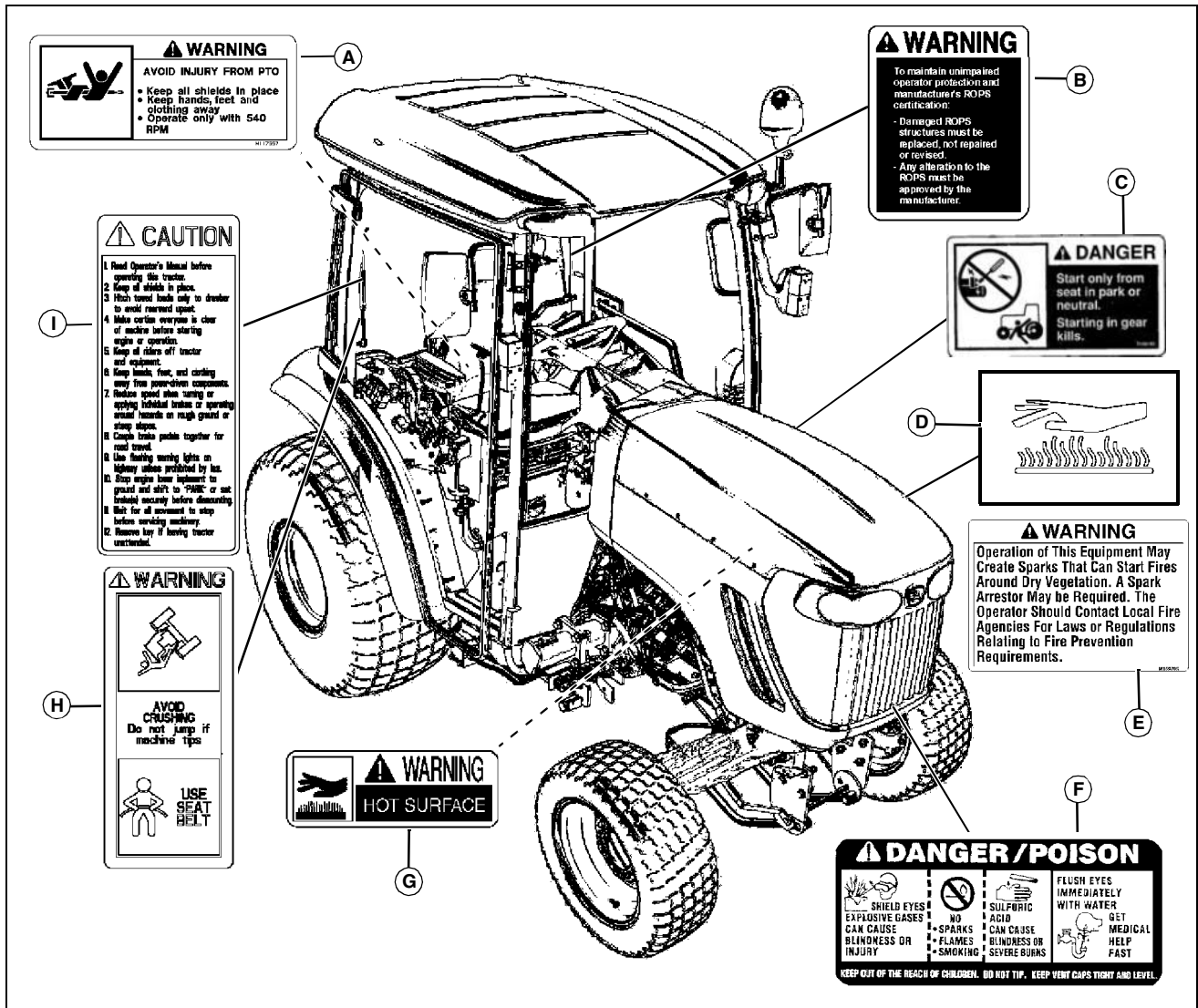

MX41878

Picture Note: Use label number listed in table below to locate complete text of safety label message following this illustration.

- A - WARNING M117557
- B - WARNING R120124
- C - DANGER T146195
- D - CAUTION HOT SURFACE (embossed on muffler)
- E - WARNING M159705
- F - DANGER/POISON M88249
- G - WARNING M117554
- H - WARNING LVU10707
- I - CAUTION MIU10747

SAFETY LABELS



Understanding The Machine Safety Labels

The machine safety labels shown in this section are placed in important areas on your machine to draw attention to potential safety hazards.

On your machine safety labels, the words DANGER, WARNING, and CAUTION are used with this safety-alert symbol. DANGER identifies the most serious hazards.

The operator's manual also explains any potential safety hazards whenever necessary in special safety messages that are identified with the word, CAUTION, and the safety-alert symbol.

WARNING ROPS R141735



R141735

If a canopy or sunshade is attached to the ROPS structure, the weight MUST be limited to 100 lb (45 kg) or less.

WARNING M117557



M117557

AVOID INJURY FROM PTO.

- Keep all shields in place.
- Keep hands, feet and clothing away.
- Operate only with 540 RPM.

DANGER T146195



T146195

Start only from seat in park or neutral.

Starting in gear kills.

CAUTION HOT SURFACE

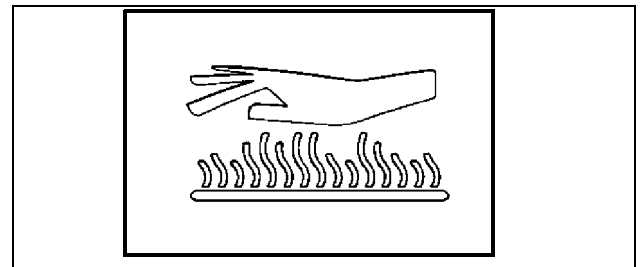

Picture Note: Located on muffler.

NOTE: No-text warning molded into muffler.

Do not touch engine muffler, it may be hot.

DANGER / POISON M88249

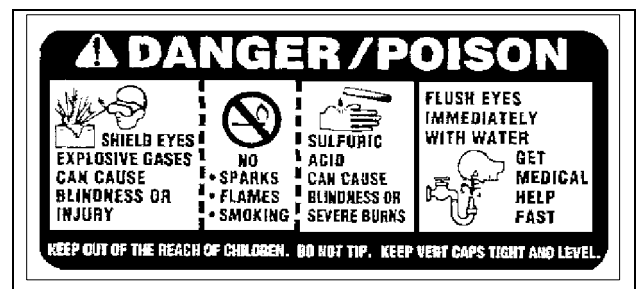

M88249

Picture Note: Located on battery.

SHIELD EYES: EXPLOSIVE GASES CAN CAUSE BLINDNESS OR INJURY.

NO SPARKS, FLAMES, SMOKING.

SULFURIC ACID CAN CAUSE BLINDNESS OR SEVERE BURNS.

FLUSH EYES IMMEDIATELY WITH WATER. GET MEDICAL HELP FAST.

SAFETY LABELS

KEEP OUT OF THE REACH OF CHILDREN. DO NOT TIP.
KEEP VENT CAPS TIGHT AND LEVEL.

WARNING AVOID CRUSHING LVU10709

CAUTION READ OPERATORS MANUAL LVU10708



LVU10708

1. Read Operator's Manual before operating this machine.
2. Keep all shields in place.
3. Hitch towed loads only to drawbar to avoid rearward upset.
4. Make certain everyone is clear of machine before starting engine or operation.
5. Keep all riders off machine and equipment.
6. Keep hands, feet and clothing away from power-driven parts.
7. Reduce speed when turning or applying individual brakes or operating around hazards on rough ground or steep slopes.
8. Couple brake pedals together for road travel.
9. Use flashing warning lights on highway unless prohibited by law.
10. Stop engine, lower implement to ground and shift to "PARK" or set brake(s) securely before dismounting.
11. Wait for all movement to stop before servicing machinery.
12. Remove key if leaving machine unattended.



LVU10709

- Keep Rollover Protective Structure fully extended.
 - Do not jump if machine tips.
 - Use seat belt.
- When structure must be down;
- DO NOT use seat belt.
 - Drive with extra care.

WARNING M117554

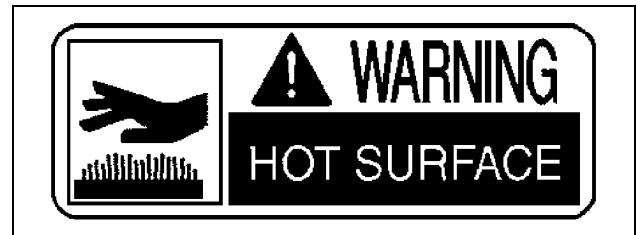

M117554

Hot surface

SAFETY LABELS

WARNING ROPS R120124



R120124

To maintain unimpaired operator protection and manufacturer's ROPS certification:

- Damaged ROPS structures must be replaced, not repaired or revised.
- Any alteration to the ROPS must be approved by the manufacturer.

CAUTION READ OPERATORS MANUAL MIU10747

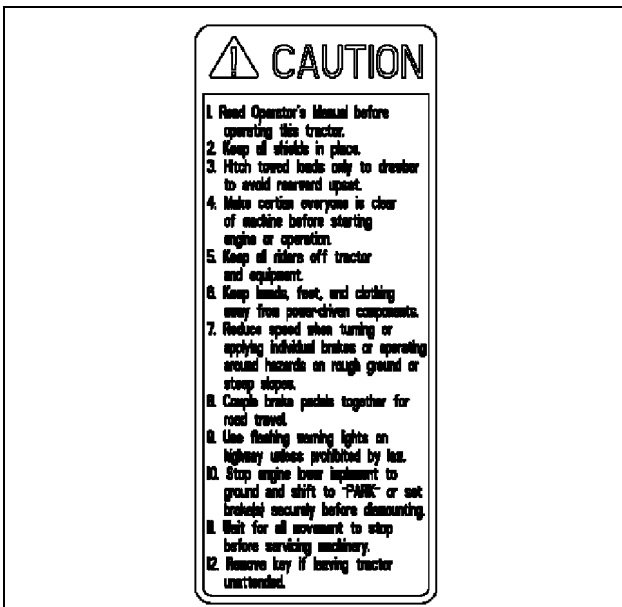

MIU10747

1. Read the operator's manual before operating the tractor.
2. Keep all shields in place.

3. Hitch towed loads only to drawbar to avoid rearward upset.
4. Make sure everyone is clear of machine before starting engine or operation.
5. Keep all riders off tractor and equipment.
6. Keep hands, feet, and clothing away from power-driven components.
7. Reduce speed when turning or applying individual brakes or operating around hazards on rough ground or steep slopes.
8. Couple brake pedals together for road travel.
9. Use flashing warning lights on highway unless prohibited by law.
10. Stop engine lower implement to ground and shift to "PARK" or set brake(s) securely before dismounting.
11. Wait for all movement to stop before servicing machinery.
12. Remove key if leaving tractor unattended.

WARNING LVU10707



LVU10707a

AVOID CRUSHING. Do not jump if machine tips.

- USE SEAT BELT.

SAFETY LABELS

CAUTION iMatch™ Quick-Hitch LVU13502



LVU13502

Picture Note: Optional iMatch Quick-Hitch.

BEFORE USING, SECURE TRACTOR IMPLEMENT WITH BOTH LOCKING LUGS OVER LOWER IMPLEMENT PINS

Warning M159705



M159705

Picture Note: This label is required and installed on machines sold in California. This label may also be installed on machines sold in other locations.

Operation of This Equipment May Create Sparks that Can Start Fires Around Dry Vegetation. A Spark Arrestor May be Required. The Operator Should Contact Local Fire Agencies For Laws or Regulations Relating to Fire Prevention Requirements.

Emission Control System Certification Label

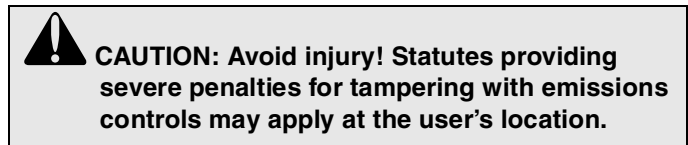
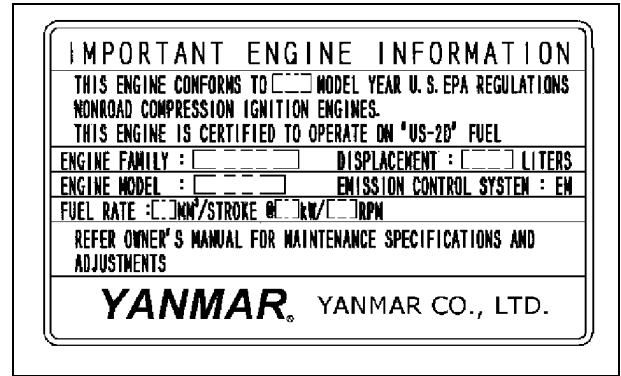

The emissions warranty described in the warranty section applies only to those engines marketed by John Deere that have been certified by the United States Environmental Protection Agency (EPA) and/or California Air Resources Board (CARB); and used in the United States in non-road mobile (self-propelled or portable/transportable¹) equipment. The presence of an emissions label like the one shown signifies that the engine has been certified with the EPA and/or CARB. The EPA and CARB warranties only apply to new engines having the certification label affixed to the engine and sold as stated above in the geographic areas governed by the regulating agencies.

NOTE: The hp/kW rating on the engine emissions certification label specifies the gross engine hp/kW, which is flywheel power without fan. In most applications this will not be the same rating as the advertised vehicle hp/kW rating.

¹.Equipment moved at least once every 12 months.

SAFETY

Operator Training Required

- Read the operator's manual and other training material. If the operator or mechanic cannot read English, it is the owner's responsibility to explain this material to them. This publication is available in other languages.
- Become familiar with the safe operation of the equipment, operator controls, and safety signs.
- All operators and mechanics should be trained. The owner of the machine is responsible for training the users.
- Never let children or untrained people operate or service the equipment. Local regulations may restrict the age of the operator.
- The owner/user can prevent and is responsible for accidents or injuries occurring to themselves, other people, or property.
- Operate the machine in an open, unobstructed area under the direction of an experienced operator.

Operating Safely

- Only allow responsible adults, who are familiar with the instructions, to operate the machine. Local regulations may restrict the age of the operator.
- A storage location is provided on the machine for the operator's manual. Keep the manual stored securely in this location when not in use and show other operators of this machine where the operator manual is located.
- Inspect machine before you operate. Be sure hardware is tight. Repair or replace damaged, badly worn, or missing parts. Be sure guards and shields are in good condition and fastened in place. Make any necessary adjustments before you operate.
- Be sure all drives are in neutral and parking brake is locked before starting engine. Only start engine from the operator's position.
- Do not change the engine governor settings or overspeed the engine. Operating the engine at excessive speed can increase the hazard of personal injury.
- Check brakes before you operate. Adjust or service brakes as necessary.
- Slow down and use extra care on hillsides. Be sure to travel in the recommended direction on hillsides. For this machine, drive up and down hillsides, not across. Turf conditions can affect the machine's stability. Use caution while operating near drop-offs.
- Stop machine if anyone enters the area. Never carry passengers and keep pets and bystanders away.
- Look behind and down before backing up to be sure of a

clear path.

- Inspect the area where the equipment is to be used and remove all objects such as rocks, toys and wire which can be thrown by the machine.
- If you hit an object or if abnormal vibration occurs, stop the machine and inspect it. Make repairs before you operate. Keep machine and attachments properly maintained and in good working order.
- Do not leave machine unattended when it is running.
- Only operate during daylight or with good artificial light.
- Evaluate the terrain to determine what accessories and attachments are needed to properly and safely perform the job.
- Use only accessories and attachments approved by the manufacturer of the machine. Keep safety labels visible when installing accessories and attachments.
- Do not operate machine if you are under the influence of drugs or alcohol.
- Check before each use that operator presence controls are functioning correctly. Test safety systems. Do not operate unless they are functioning correctly.
- Slow down and be careful of traffic when operating near or crossing roadways. Use care when approaching blind corners, shrubs, trees, or other objects that may obscure vision.
- Do not wear radio or music headphones. Safe service and operation require your full attention.
- Use care when loading or unloading the machine into or off of a trailer or truck.
- Disengage drive to attachments when transporting or not in use.
- Reduce the throttle setting during engine run-out and, if the engine is provided with a fuel shut-off valve, turn the fuel off at the conclusion of mowing.
- When machine is left unattended, stored, or parked, lower the mower deck unless a positive mechanical lock is used.

Using a Spark Arrestor

The engine in this machine is not equipped with a spark arrestor muffler. The California Public Resources Code, section 4442.5 provides as follows:

No person shall sell, offer for sale, lease, or rent to any person any internal combustion engine subject to Section 4442 or 4443, and not subject to Section 13005 of the Health and Safety Code, unless the person provides a written notice to the purchaser or bailee, at the time of sale or at the time of entering into the lease or rental contract,

SAFETY

stating that it is a violation of Section 4442 or 4443 to use or operate the engine on any forest-covered, brush-covered, or grass-covered land unless the engine is equipped with a spark arrestor, as defined in Section 4442, maintained in effective working order or the engine is constructed, equipped, and maintained for the prevention of fire pursuant to Section 4443. Cal. Pub. Res. Code 4442.5.

Other states or jurisdictions may have similar laws. A spark arrestor for your machine may be available from your authorized dealer. An installed spark arrestor must be maintained in good working order by the operator.

Parking Safely

1. Stop machine on a level surface, not on a slope.
2. Disengage PTO and stop attachments.
3. Lower attachments to the ground.
4. Lock park brake.
5. Stop engine.
6. Remove key.
7. Wait for engine and all moving parts to stop before you leave the operator's station.
8. Close fuel shut off valve before servicing the fuel system, if your machine is equipped.
9. Disconnect the battery ground cable before making repairs to electrical system or doing any welding.

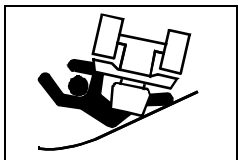

Avoid Tipping

- Slopes are a major factor related to loss-of-control and tip-over accidents, which can result in severe injury or death. Operation on all slopes

requires extra caution.

- Be aware that mechanical front wheel drive (MFWD) can improve access to dangerously sloped terrain, thereby increasing the possibility of a tipover.
- Drive up and down a hill - not across.
- Watch for holes, ruts, bumps, rocks, or other hidden objects. Uneven terrain could overturn the machine. Tall grass can hide obstacles.
- Do not operate machine on wet grass. Tires may lose traction. Tires may lose traction on slopes even though the brakes are functioning properly.
- Choose a low ground speed so you will not have to stop or shift while on a slope.

- Always keep the machine in gear when going down slopes. Do not shift to neutral and coast downhill.
- Avoid starting, stopping or turning on a slope. If the tires lose traction, disengage the blades and proceed slowly, straight down the slope.
- Keep all movement on slopes slow and gradual. Do not make sudden changes in speed or direction, which could cause the machine to roll over.
- Do not operate machine near drop-offs, ditches, embankments, or bodies of water. The machine could suddenly roll over if a wheel goes over the edge or the edge caves in. Leave a safety area between the machine and any hazard.
- Danger of tipping is increased greatly with tires in narrow tread setting and driving at high speed.
- Follow the manufacturer's recommendations for wheel weights or counterweights for added stability when operating on slopes or using front or rear mounted attachments. Remove weights when not required.

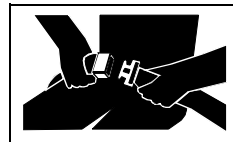

Use Seat Belt Properly

- Use a seat belt when operating with the folding Roll-Over Protective Structure (ROPS) in the upright position to minimize chance of injury from an accident, such as an overturn.
- Do not use a seat belt when operating with the folding ROPS in the folded position. Return the folding ROPS to the upright position as soon as possible.
- Never modify, disassemble or attempt to repair the seat belt.
- Replace entire seat belt if mounting hardware, buckle, belt, or retractor show signs of damage.
- Inspect seat belt and mounting hardware at least once a year. Look for signs of loose hardware or belt damage, such as cuts, fraying, extreme or unusual wear, discoloration, or abrasion. Replace only with John Deere-approved replacement parts.
- Layers of heavy clothing can interfere with proper positioning of the seat belt and can reduce the effectiveness of the seat belt.

Keep ROPS Installed Properly

- Never operate the machine without the ROPS installed.
- Make certain all parts of the ROPS are installed correctly if the ROPS structure is loosened or removed for any reason. All ROPS hardware should be tightened to the

SAFETY

proper torque per manufacturer's recommendations.

- Any alteration of the ROPS must be approved by the manufacturer. The protection provided by the ROPS will be impaired if the ROPS is subjected to structural damage, is involved in an overturn incident, or is in any way altered by welding, bending, drilling, or cutting.
- The seat is part of the ROPS safety zone. Replace only with John Deere-approved seat.
- Never attempt to repair a damaged or altered ROPS. It must be replaced to maintain the manufacturer's certification of the structure.



Keep Riders Off

- Only allow the operator on the machine. Keep riders off.
- Riders on the machine or attachment may be struck by foreign

objects or thrown off the machine causing serious injury.

- Riders obstruct the operator's view resulting in the machine being operated in an unsafe manner.

Towing Loads Safely

- Stopping distance increases with speed and weight of towed load. Travel slowly and allow extra time and distance to stop.
- Total towed weight must not exceed combined weight of pulling machine, ballast and operator. Use counterweights or wheel weights as described in the attachment or pulling machine operator's manual.
- Excessive towed load can cause loss of traction and loss of control on slopes. Reduce towed weight when operating on slopes.
- Never allow children or others in or on towed equipment.
- Use only approved hitches. Tow only with a machine that has a hitch designed for towing. Do not attach towed equipment except at the approved hitch point.
- Follow the manufacturer's recommendations for weight limits for towed equipment and towing on slopes.
- If you cannot back up a slope with a towed load, the slope is too steep to operate on with the towed load. Reduce the towed load or do not operate.
- Do not turn sharply. Use additional caution when turning or operating under adverse surface conditions. Use care when reversing.
- Do not shift to neutral and coast downhill.

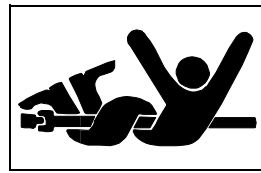

Stay Clear of Rotating Drivelines

Entanglement in rotating driveline can cause serious injury or death.

- Wear close fitting clothing.
- Stop the engine and be sure PTO driveline is stopped before getting near it.

Checking Wheel Hardware

- A serious accident could occur causing serious injury if wheel hardware is not tight.
- Check wheel hardware tightness often during the first 100 hours of operation.
- Wheel hardware must be tightened to specified torque using the proper procedure anytime it is loosened.

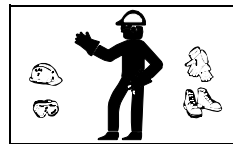

Wear Appropriate Clothing

- Always wear safety goggles, or safety glasses with side shields, and a hard hat when operating the machine.

- Wear close fitting clothing and safety equipment appropriate for the job.
- While mowing, always wear substantial footwear and long trousers. Do not operate the equipment when barefoot or wearing open sandals.
- Wear a suitable protective device such as earplugs. Loud noise can cause impairment or loss of hearing.

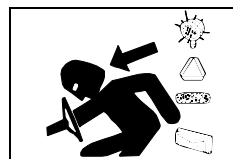

Driving Safely on Public Roads

Avoid personal injury or death resulting from a collision with another vehicle on public roads:

- Use safety lights and devices. Slow moving machines when driven on public roads are hard to see, especially at night.
- Whenever driving on public roads, use flashing warning lights and turn signals according to local regulations. Extra flashing warning lights may need to be installed.

SAFETY



Practice Safe Maintenance

- Only qualified, trained adults should service this machine. Understand service procedure before doing work.
- Never operate machine in a closed area where dangerous carbon monoxide fumes can collect.
- Keep all nuts and bolts tight, especially blade attachment bolts, to be sure the equipment is in safe working condition.
- Never tamper with safety devices. Check their proper operation regularly.
- Keep machine free of grass, leaves or other debris build-up. Clean up oil or fuel spillage and remove any fuel-soaked debris. Allow the machine to cool before storing.
- Never make any adjustments or repairs with the engine running. Wait for all movement to stop on machine before adjusting, cleaning or repairing.
- Check brake operation frequently. Adjust and service as required.
- Maintain or replace safety and instruction labels, as necessary.
- Keep hands, feet, clothing, jewelry, and long hair away from any moving parts, to prevent them from getting caught.
- Lower any attachments to the ground before cleaning or servicing machine. Disengage all power and stop the engine. Lock park brake and remove the key. Let machine cool.
- Securely support any machine elements that must be raised for service work. Use jack stands or lock service latches to support components when needed.
- Disconnect battery or remove spark plug wire (for gasoline engines) before making any repairs. Disconnect negative terminal first and positive last. Install positive terminal first and negative last.
- Before servicing machine or attachment, carefully release pressure from any components with stored energy, such as hydraulic components or springs.
- Release hydraulic pressure by lowering attachment or cutting units to the ground or to a mechanical stop and move hydraulic control levers back and forth.
- Keep all parts in good condition and properly installed. Fix damage immediately. Replace worn or broken parts.
- Charge batteries in an open, well-ventilated area, away from sparks. Unplug battery charger before connecting or disconnecting from the battery. Wear protective clothing and use insulated tools.



Avoid High Pressure Fluids

- Hydraulic hoses and lines can fail due to physical damage, kinks, age, and exposure. Check hoses and lines regularly. Replace damaged hoses and lines.
- Hydraulic fluid connections can loosen due to physical damage and vibration. Check connections regularly. Tighten loose connections.
- Escaping fluid under pressure can penetrate the skin causing serious injury. Avoid the hazard by relieving pressure before disconnecting hydraulic or other lines. Tighten all connections before applying pressure.
- Search for leaks with a piece of cardboard. Protect hands and body from high pressure fluids.
- If an accident occurs, see a doctor immediately. Any fluid injected into the skin must be surgically removed within a few hours or gangrene may result. Doctors unfamiliar with this type of injury should reference a knowledgeable medical source. Such information is available from Deere & Company Medical Department in Moline, Illinois, U.S.A. Information may be obtained in the United States and Canada only by calling 1-800-822-8262.

Prevent Fires

- Remove grass and debris from engine compartment and muffler area, before and after operating machine.
- Always shut off fuel when storing or transporting machine, if the machine has a fuel shutoff.
- Do not store machine near an open flame or source of ignition, such as a water heater or furnace.
- Check fuel lines, tank, cap, and fittings frequently for cracks or leaks. Replace if necessary.



Tire Safety

Explosive separation of a tire and rim parts can cause serious injury or death:

- Do not attempt to mount a tire without the proper equipment and experience to perform the job.
- Always maintain the correct tire pressure. Do not inflate the tires above the recommended pressure. Never weld or heat a wheel and tire assembly. The heat can cause an increase in air pressure resulting in a tire explosion. Welding can structurally weaken or deform the wheel.
- When inflating tires, use a clip-on chuck and extension

SAFETY

hose long enough to allow you to stand to one side and NOT in front of or over the tire assembly.

- Check tires for low pressure, cuts, bubbles, damaged rims or missing lug bolts and nuts.

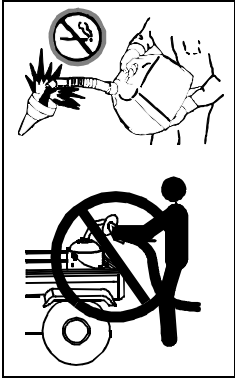

Handling Fuel Safely

To avoid personal injury or property damage, use extreme care in handling fuel. Fuel is extremely flammable and fuel vapors are explosive:

- Extinguish all cigarettes, cigars, pipes, and other sources of ignition.
- Use only an approved fuel container. Use only non-metal, portable fuel containers approved by

the Underwriter's Laboratory (U.L.) or the American Society for Testing & Materials (ASTM). If using a funnel, make sure it is plastic and has no screen or filter.

- Never remove the fuel tank cap or add fuel with the engine running. Allow engine to cool before refueling.
- Never add fuel to or drain fuel from the machine indoors. Move machine outdoors and provide adequate ventilation.
- Clean up spilled fuel immediately. If fuel is spilled on clothing, change clothing immediately. If fuel is spilled near machine, do not attempt to start the engine but move the machine away from the area of spillage. Avoid creating any source of ignition until fuel vapors have dissipated.
- Never store the machine or fuel container where there is an open flame, spark, or pilot light such as on a water heater or other appliance.
- Prevent fire and explosion caused by static electric discharge. Static electric discharge can ignite fuel vapors in an ungrounded fuel container.
- Never fill containers inside a vehicle or on a truck or trailer bed with a plastic liner. Always place containers on the ground away from your vehicle before fueling.
- Remove fuel-powered equipment from the truck or trailer and refuel it on the ground. If this is not possible, then refuel such equipment with a portable container, rather than from a fuel dispenser nozzle.
- Keep the nozzle in contact with the rim of the fuel tank or container opening at all times until the fueling is complete. Do not use a nozzle lock-open device.
- Never overfill fuel tank. Replace fuel tank cap and tighten securely.
- Replace all fuel container caps securely after use.
- For gasoline engines, do not use gas with methanol.

Methanol is harmful to your health and to the environment.

Handling Waste Product and Chemicals

Waste products, such as, used oil, fuel, coolant, brake fluid, and batteries, can harm the environment and people:

- Do not use beverage containers for waste fluids - someone may drink from them.
- See your local Recycling Center or authorized dealer to learn how to recycle or get rid of waste products.
- A Material Safety Data Sheet (MSDS) provides specific details on chemical products: physical and health hazards, safety procedures, and emergency response techniques. The seller of the chemical products used with your machine is responsible for providing the MSDS for that product.

OPERATING - CONTROLS

Operator Station Controls (PowrReverser)

NOTE: All controls shown may not be installed on your machine.

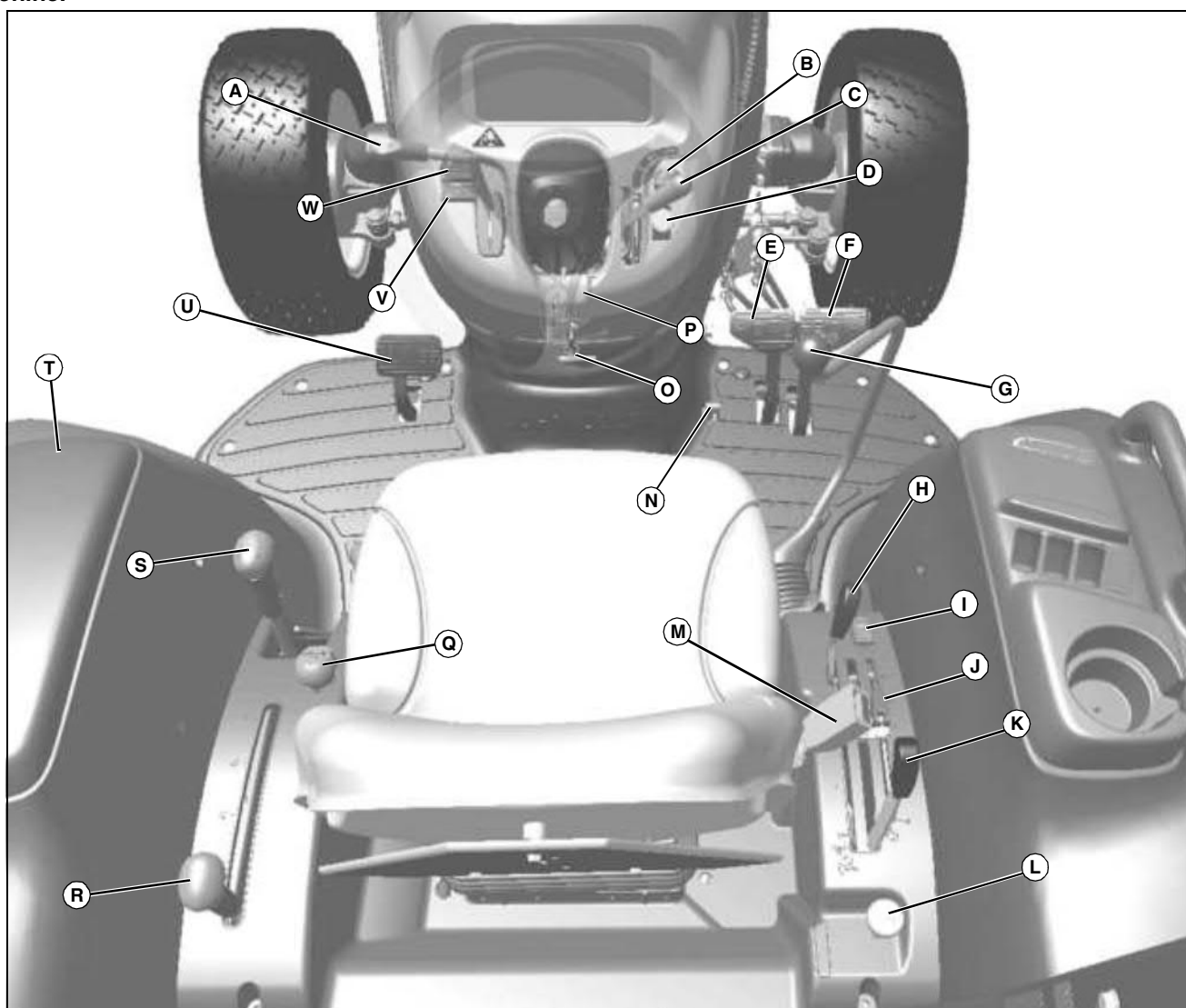

MX36390a

- | | |
|------------------------------------------------------|-----------------------------------------------------|
| A - Reverser Lever | N - Engine Speed Foot Throttle |
| B - Light Control Switch | O - Ignition Key Switch |
| C - Engine Speed Hand Throttle Lever | P - Tilt Steering Control Lever |
| D - Rear Power-Take-Off (PTO) Engagement Knob | Q - Mechanical Front Wheel Drive (MFWD) Knob |
| E - Left Turn Brake Pedal | R - Transmission Range Shift Lever |
| F - Right Turn Brake Pedal | S - Transmission Range Shift Lever |
| G - Dual Selective Control Valve (SCV) Lever | T - Operator Manual Holder |
| H - Third SCV Lever | U - Clutch Pedal |
| I - Diverter Valve Switch | V - Turn Signal Switch |
| J - Rockshaft Adjustable Depth Stop Knob | W - Display Mode Switch |
| K - Rockshaft Control Lever | |
| L - Mid-PTO Engagement Knob | |
| M - Seat Belt | |

OPERATING - CONTROLS

Operator Station Controls (eHydro No Cab)

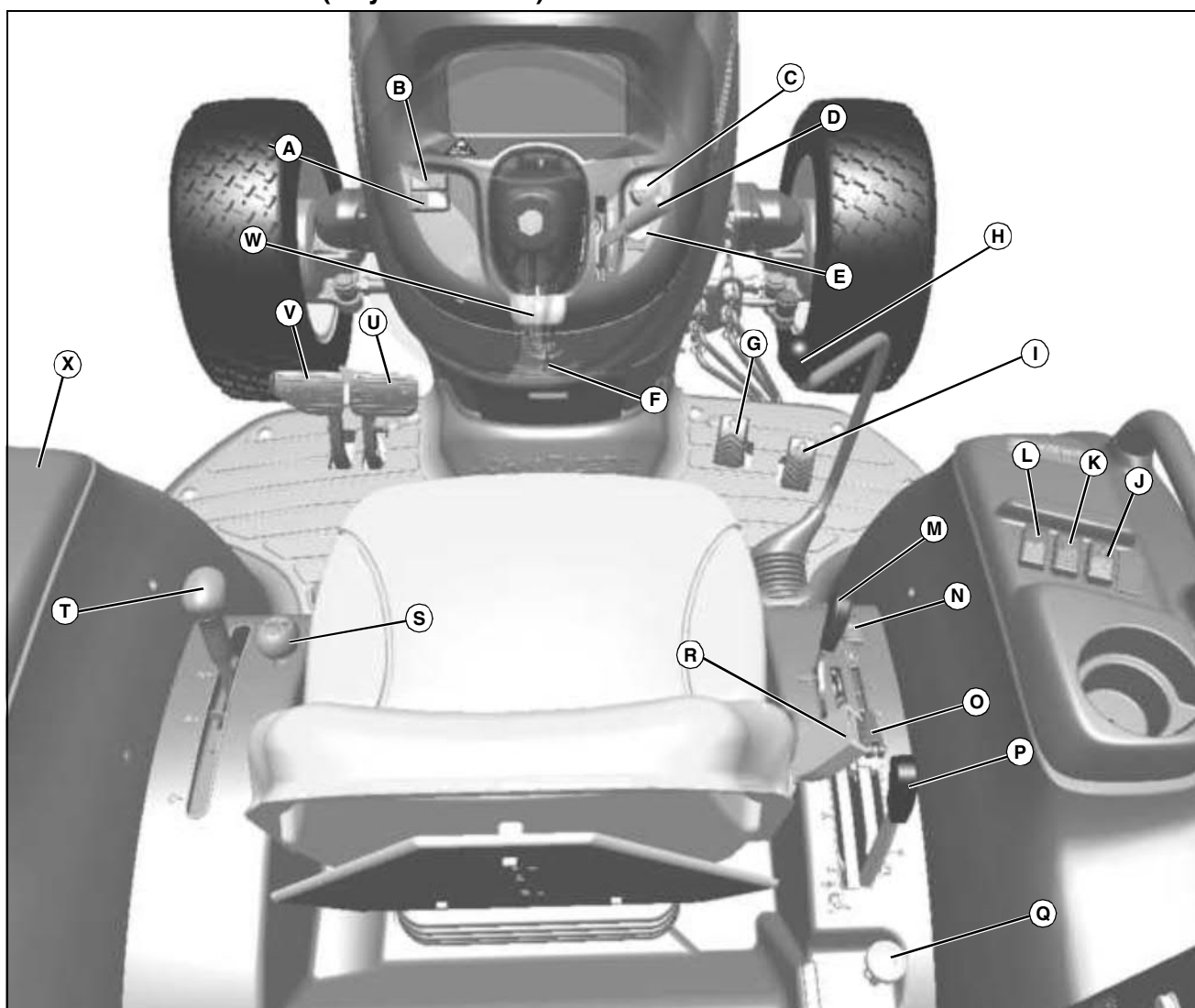

MX36389a

- | | |
|-----------------------------------------------|----------------------------------------------|
| A - Turn Signal Switch | Q - Mid-PTO Engagement Knob |
| B - Display Mode Switch | R - Seat Belt |
| C - Light Control Switch | S - Mechanical Front Wheel Drive (MFWD) Knob |
| D - Engine Speed Hand Throttle Lever | T - Transmission Range Shift Lever |
| E - Rear Power-Take-Off (PTO) Engagement Knob | U - Right Turn Brake Pedal |
| F - Ignition Key Switch | V - Left Turn Brake Pedal |
| G - Forward Travel Pedal | W - Tilt Steering Control Lever |
| H - Dual Selective Control Valve (SCV) Lever | X - Operator Manual Holder |
| I - Reverse Travel Pedal | |
| J - MotionMatch™ Switch | |
| K - Accel/Decel Switch | |
| L - Cruise Control Switch | |
| M - Third SCV Lever | |
| N - Diverter Valve Switch | |
| O - Rockshaft Adjustable Depth Stop Knob | |
| P - Rockshaft Control Lever | |

OPERATING - CONTROLS

Operator Station Controls (eHydro With Cab)

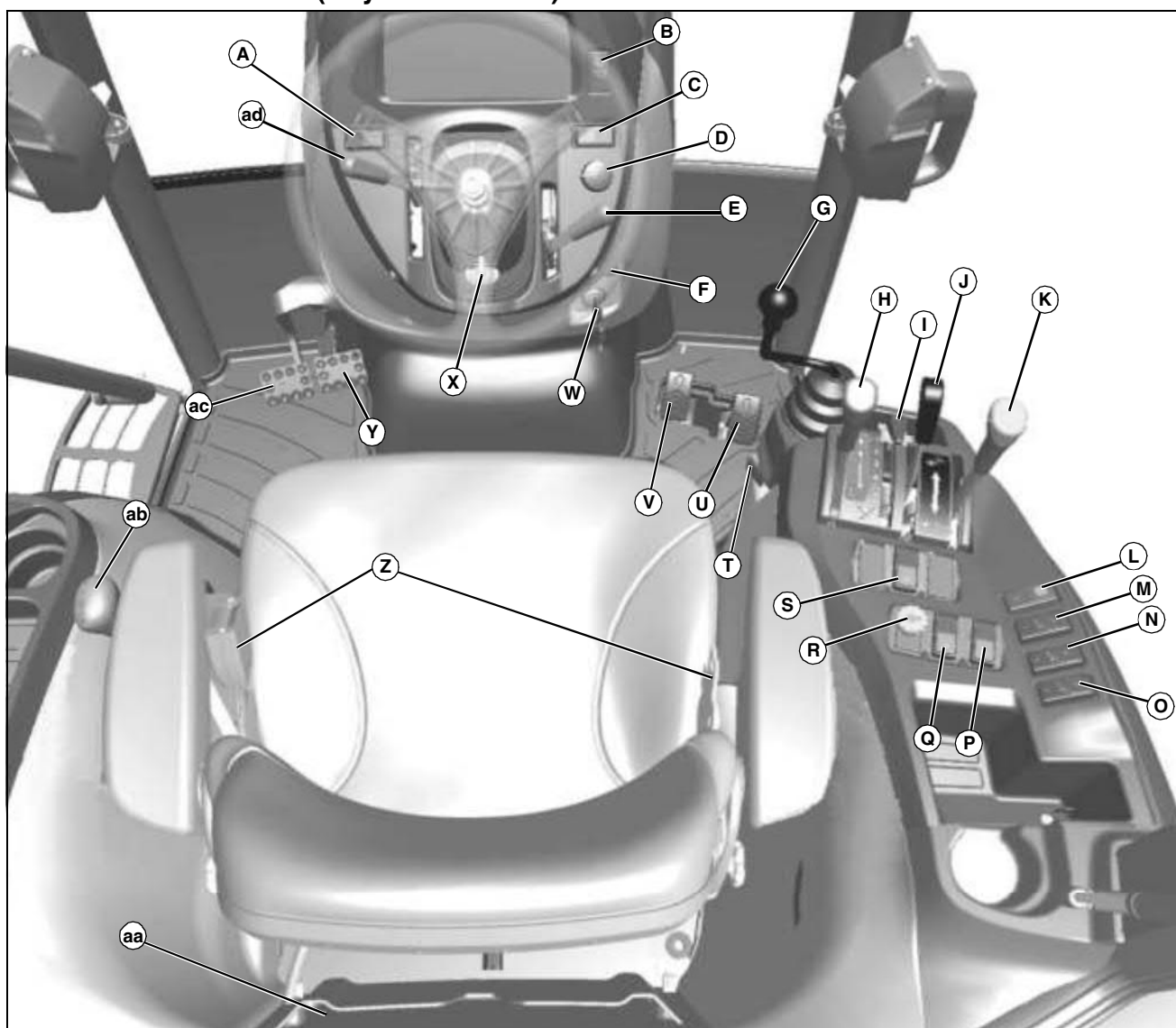

MX36391b

- | | |
|-----------------------------------------------------|------------------------------------------------------|
| A - Turn Signal Switch | P - Rear Work Lights |
| B - Front Windshield Wiper/Washer Switch | Q - Rear Windshield Washer Switch |
| C - Display Mode Switch | R - Rear/Mid PTO Engagement Knob |
| D - Light Control Switch | S - Diverter Switch |
| E - Engine Speed Hand Throttle Lever | T - SCV Lock Lever |
| F - Park Brake Switch | U - Reverse Travel Pedal |
| G - Dual Selective Control Valve (SCV) Lever | V - Forward Travel Pedal |
| H - Third SCV Lever | W - Keyswitch |
| I - Rockshaft Adjustable Depth Stop Knob | X - Tilt Steering Control Lever |
| J - Rockshaft Control Lever | Y - Right Turn Brake Pedal |
| K - Power-Take-Off (PTO) Selector Lever | Z - Seat Belt |
| L - Beacon Switch | AA- Operator Manual Holder |
| M - Cruise Control Switch | AB- Transmission Range Shift Lever |
| N - Accel/Decel Switch | AC- Left Turn Brake Pedal |
| O - MotionMatch™ Switch | AD- Mechanical Front Wheel Drive (MFWD) Lever |

OPERATING - CONTROLS

Floor Panel Controls

Tractor (No Cab)

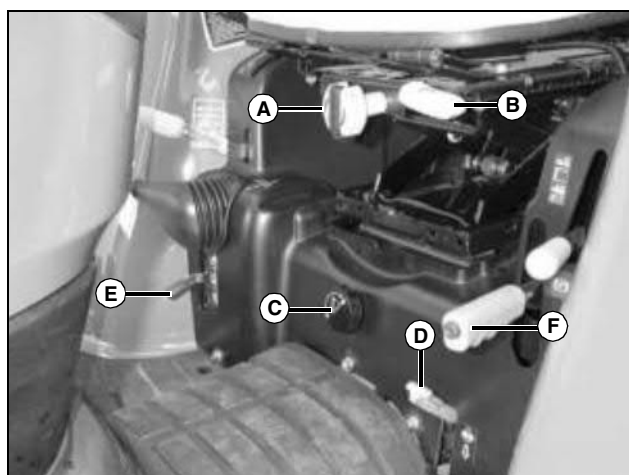

MX20922

Picture Note: eHydro model shown. Differential lock pedal is located on right side of floor panel controls on PowrReverser model.

- A - Operator Seat Weight Adjustment Knob
- B - Operator Seat Adjustment Lever
- C - Rockshaft Rate-of-Drop Control Knob
- D - Differential Lock Pedal
- E - Dual Selective Control Valve (SCV) Lock Lever
- F - Park Brake Lever

Tractor With Cab (Standard Seat)

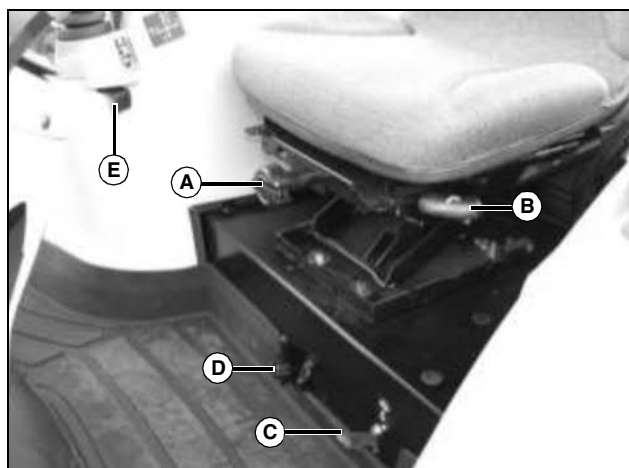

MX22969

- A - Operator Seat Weight Adjustment Knob
- B - Operator Seat Adjustment Lever
- C - Differential Lock Pedal
- D - Rockshaft Rate-of-Drop Control Knob
- E - Dual Selective Control Valve (SCV) Lock Lever

Tractor With Cab (Deluxe Seat)

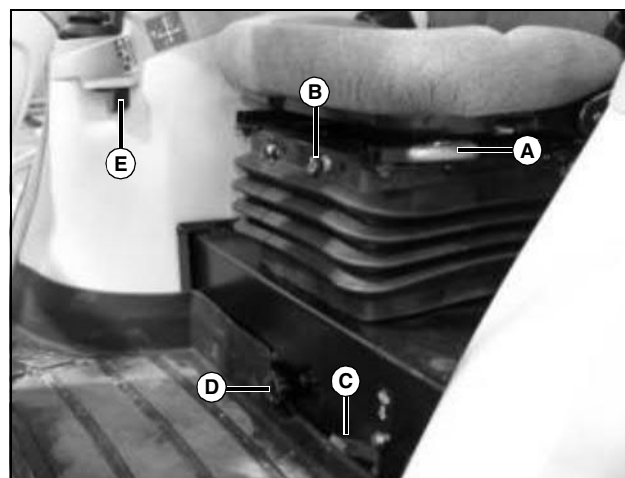

MX22965

- A - Operator Seat Adjustment Lever
- B - Operator Seat Weight Adjustment Knob
- C - Differential Lock Pedal
- D - Rockshaft Rate-of-Drop Control Knob
- E - Dual Selective Control Valve (SCV) Lock Lever

Air Temperature Controls

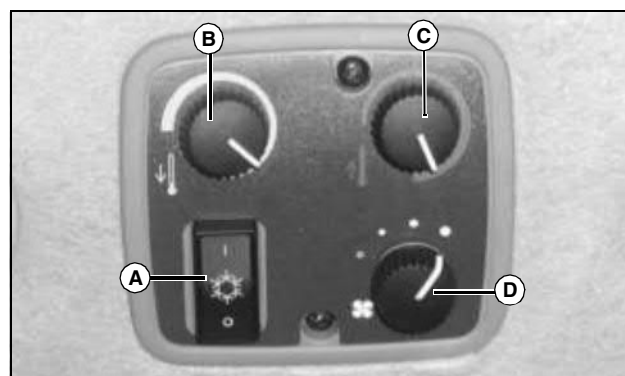

MX22964

- A - Air Conditioning and Deicing Switch
- B - Air Conditioning Temperature Control Knob
- C - Heater Temperature Control Knob
- D - Blower Speed Control Knob

OPERATING - MACHINE

Daily Operating Checklist

- Test safety systems. Perform safety interlock system checkout procedure.
- Check engine oil level.
- Check transmission oil level.
- Check air filter rubber dust unloading valve.
- Check radiator coolant level.
- Drain water from fuel filter bowl daily to avoid premature engine failure.

Avoid Damage to Plastic and Painted Surfaces

- Do not wipe plastic parts unless rinsed first.
- Insect repellent spray may damage plastic and painted surfaces. Do not spray insect repellent near machine.
- Be careful not to spill fuel on machine. Fuel may damage surface. Wipe up spilled fuel immediately.

Entering and Exiting Machine

Using Step



MX35832

Picture Note: Tractor with cab shown.

Step (A) is located on the left side of machine. Use step for entering and exiting the operator station.

Using Left Side Door (Tractor with Cab)

To enter cab, press button on handle (B) and open door. Close door until door locks into closed position.

To exit cab, push button on inside of door handle and open door.

Emergency Exit

Open glass panel on right side of cab to exit only in an emergency situation.

Adjusting Seat (No Cab)

Before starting engine to operate machine, adjust operator seat position, height and suspension.

Adjusting Seat Position

1. Sit on the operator seat.

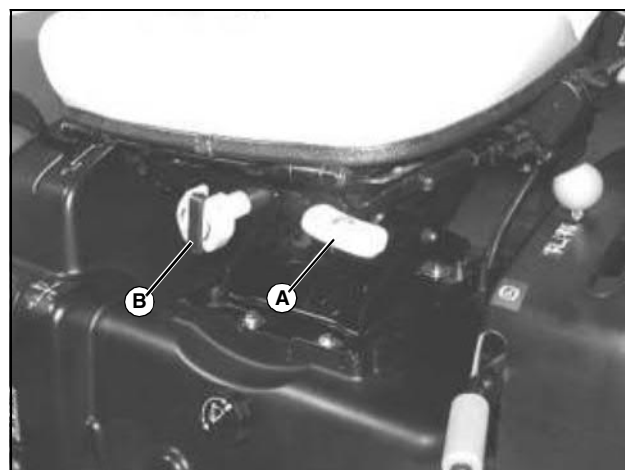

MX32704

2. Rotate operator seat adjustment lever (A) clockwise.
3. Slide seat forward or rearward to desired position.
4. Release lever to lock seat in position where all controls can be easily reached.

Adjusting Seat For Operator Weight

1. Flip out handle (B) on operator seat weight adjustment knob.
2. Turn handle clockwise or counterclockwise to reach desired suspension travel for operator weight. Suspension should not bottom out when properly adjusted.
3. Return handle to closed position.

OPERATING - MACHINE

Adjusting Seat (Tractor With Cab)

Adjusting Standard Seat Position

1. Sit on the operator seat.

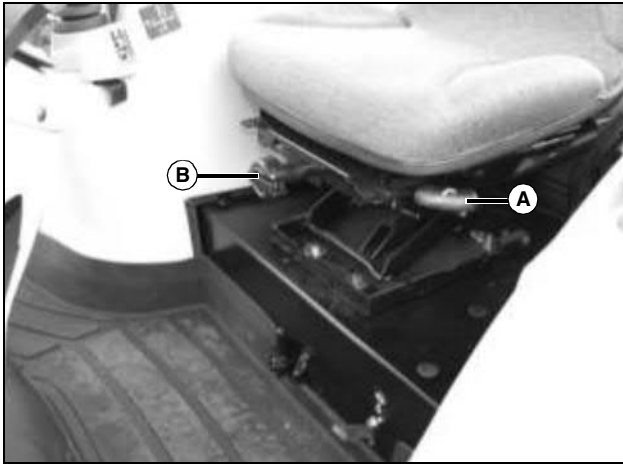

2. Rotate operator seat adjustment lever (A) counterclockwise.
3. Slide seat forward or rearward to desired position.
4. Release lever to lock seat in position where all controls can be easily accessed.

Adjusting Standard Seat For Operator Weight

1. Flip out handle (B) on operator seat weight adjustment knob.
2. Turn handle clockwise or counterclockwise to reach desired suspension travel for operator weight. Suspension should not bottom out when properly adjusted.
3. Return handle to closed position.

Adjusting Deluxe Seat Position

1. Sit on the operator seat.

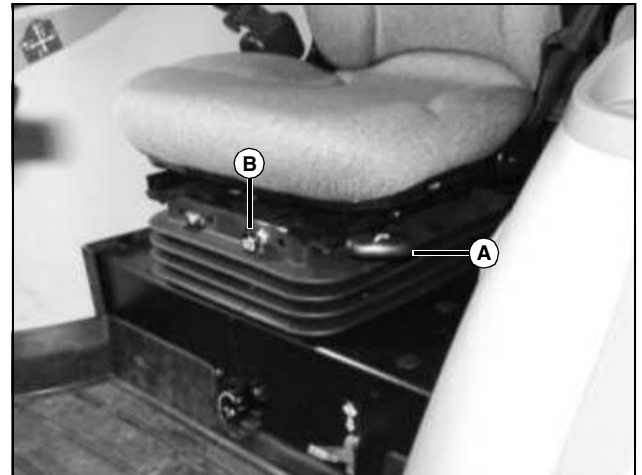

2. Rotate operator seat adjustment lever (A) counterclockwise.
3. Slide seat forward or rearward to desired position.
4. Release lever to lock seat in position. Make sure all controls can be easily accessed.

Adjusting Deluxe Seat For Operator Weight

1. Lock park brake and start engine.
2. Pull out on seat weight adjustment knob (B) to increase the air pressure within the seat air diaphragm until desired suspension travel for operator weight. Suspension should not bottom out when properly adjusted.
3. Push in on the knob (B) to release air pressure from the seat air diaphragm until desired suspension travel for operator weight. Suspension should not bottom out when properly adjusted.
4. Stop engine.

Using Seat Belt



CAUTION: Avoid injury! Always wear seat belt when operating machine with non-folding Roll-Over Protective Structure (ROPS) or folding ROPS in upright position. Do not jump from machine if machine tips.

If folding ROPS must be folded to operate in a low clearance area, do not use seat belt. Raise ROPS and use seat belt as soon as conditions permit.

OPERATING - MACHINE

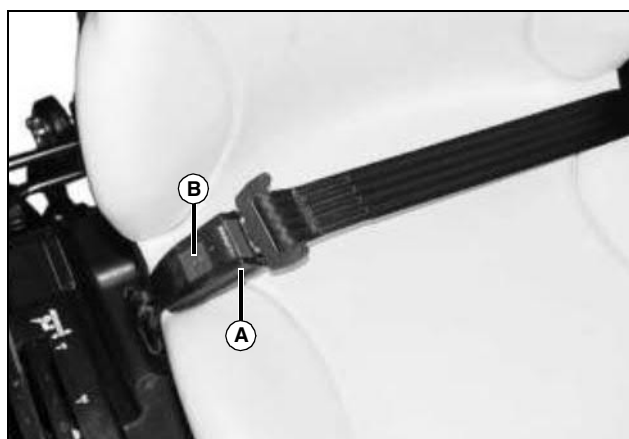

MX32691

Picture Note: Tractor without cab.

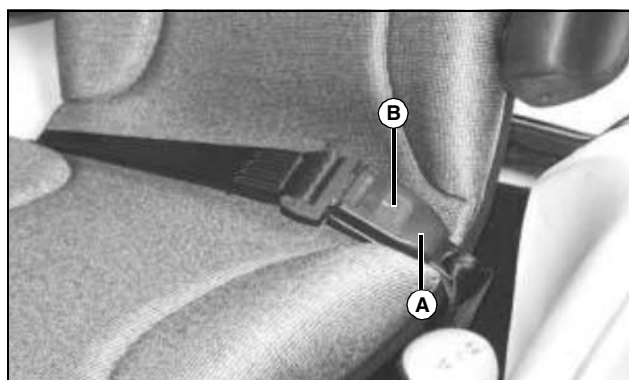

MX35764

Picture Note: Tractor with cab.

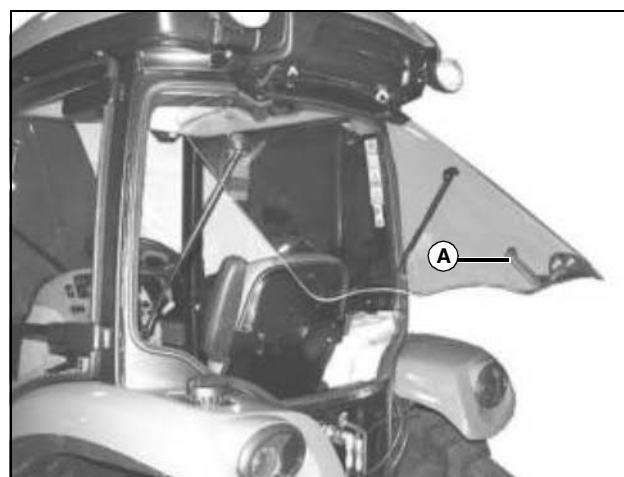

MX35770

Release latch (A) on inside of rear window and push window out to open. Pull window shut to close and secure latch.

Emergency Exit

Exit through rear window if cab doors are blocked in an emergency situation.

Using Temperature Controls

Air Conditioner and Deicing System

Push top half of air conditioning and deicing switch to turn system ON. Push bottom half of switch to turn system OFF.

Adjusting Air Conditioning Temperature

Turn air conditioning temperature control knob clockwise to circulate warmer air through vents. Turn knob counterclockwise to circulate cooler air through vents. The thicker the blue bar is on knob label indicates a cooler temperature setting and a thin bar indicates a less cool setting.

Adjusting Heater Temperature

Turn heater temperature control knob clockwise to circulate warmer air through vents. Turn knob counterclockwise to circulate cooler air through vents. The thicker the red bar is on knob label indicates a warmer temperature setting and a thin bar indicates a less warm setting.

Fasten Belt

1. Pull belt end across operator lap.
2. Install tab into buckle (A).
 - A click will be heard when the tab locks into the buckle.

Release Belt

1. Press red button (B) to release seat belt allowing the belt to retract.

Using Rear Window

Opening and Closing Rear Window

IMPORTANT: Avoid damage! Check to be sure 3-point hitch arms and attached rear implements are out of way before opening rear window.

OPERATING - MACHINE

Adjusting Blower Speed

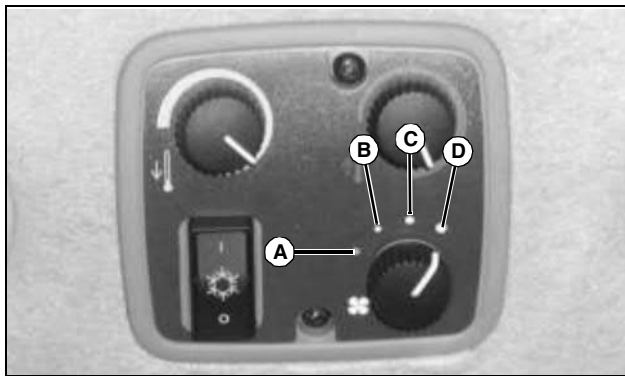

MX22964

- A - Off
- B - Low
- C - Medium
- D - High

Turn blower speed control knob to desired setting.

Adjusting Tilt Steering Wheel



CAUTION: Avoid injury! Do not attempt to adjust the steering wheel while the machine is moving. The operator can lose control of the machine.

- Stop the machine before adjusting the steering wheel.
- Lock the steering wheel in position before driving the machine.

1. Stop machine.
2. Pull tilt steering control lever up to release steering wheel.
3. Adjust steering wheel to desired position.
4. Release tilt steering control lever to lock steering wheel in position.

Using Light Switch



CAUTION: Avoid injury! Do not operate on roads with light switch in the field position. Rear work lights may blind or confuse operators of oncoming vehicles.

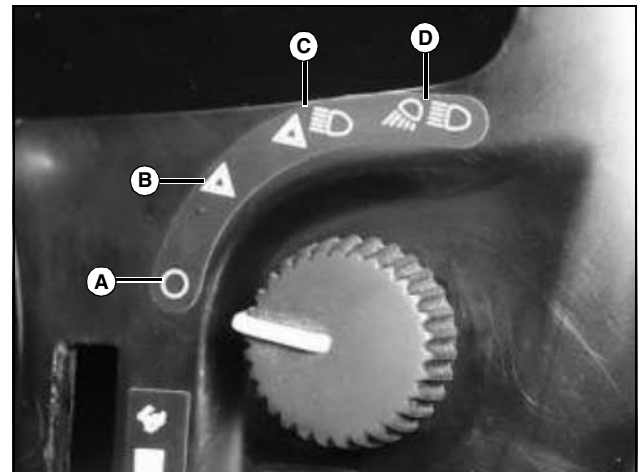

MX32692

Picture Note: Tractor without cab shown.

- A - All lights off.
- B - Warning flasher lights and taillights on.
- C - Road Position: headlights, taillights, and warning flasher lights on.
- D - Field Position: headlights and optional working lights on.

With the key switch in the off position, you can view the hour meter in the instrument panel by turning the light switch to (B) or (C) position.

Using Dome Light

IMPORTANT: Avoid damage! Before exiting cab, make sure dome light is in OFF position or DOOR position. Failure to do so will cause battery to lose its charge.

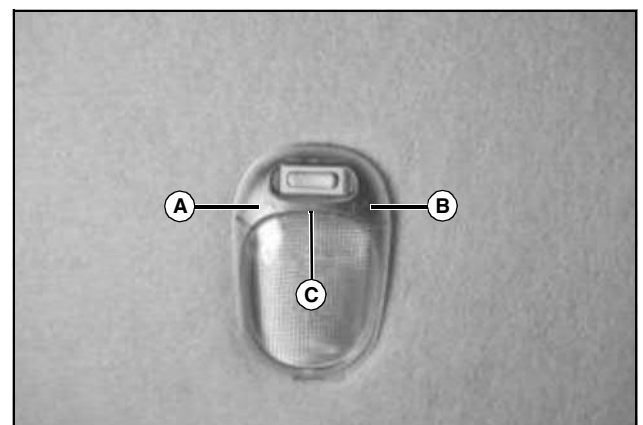

MX35775

Dome light has three positions:

- ON (A) - Dome light comes on.

OPERATING - MACHINE

- DOOR (B) - Dome light comes on when left side door is opened and turns off when door is closed.
- OFF (C) - Dome light does not light.

Using Key Switch

Tractor without Cab

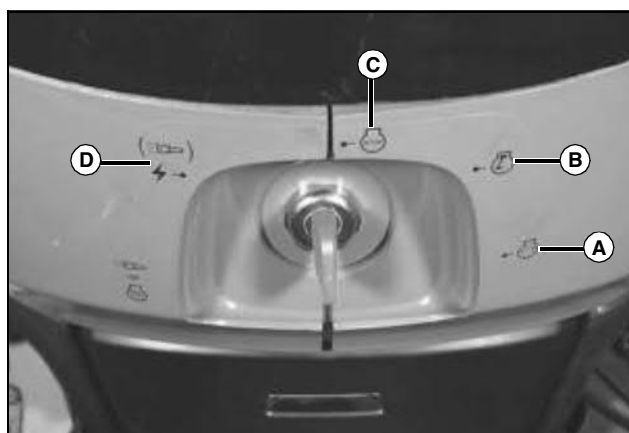

MX32693

A-Start Position - Turn the key to the start position to start the engine. Release the key after the engine has started and it will automatically return to the run position. The engine will continue to run.

B-Run Position - With the key in the run position, and the engine not running, the engine oil pressure light should flash and the battery charging light should illuminate. Both lights should turn off when the engine is running. You will also hear a clicking noise when the engine fuel shut-off solenoid engages. With the key in the run position, push the key in to activate the air intake heater system.

C-Off Position - With the key in the off position, all switched power is off, and the engine should not run.

IMPORTANT: Avoid damage! There is an accessory key switch position (D) to the left of the key switch off position. Do not move the key switch to this position. The battery could be drained.

Tractor with Cab

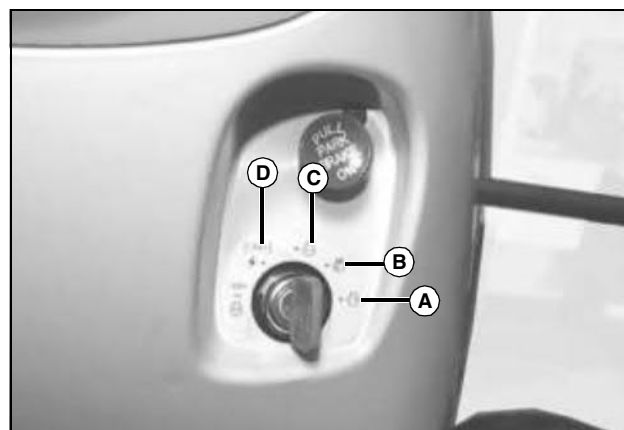

MX35876

A-Start Position - Turn the key to the start position to start the engine. Release the key after the engine has started and it will automatically return to the run position. The engine will continue to run.

B-Run Position - With the key in the run position, and the engine not running, the engine oil pressure light should flash and the battery charging light should illuminate. Both lights should turn off when the engine is running. You will also hear a clicking noise when the engine fuel shut-off solenoid engages. With the key in the run position, push the key in to activate the air intake heater system.

C-Off Position - With the key in the off position, all switched power is off, and the engine should not run.

IMPORTANT: Avoid damage! There is an accessory key switch position. Push key inward and turn counterclockwise to place key into the accessory position. Be careful not to accidentally move key into this position. Battery could be drained.

Using the Instrument Panel

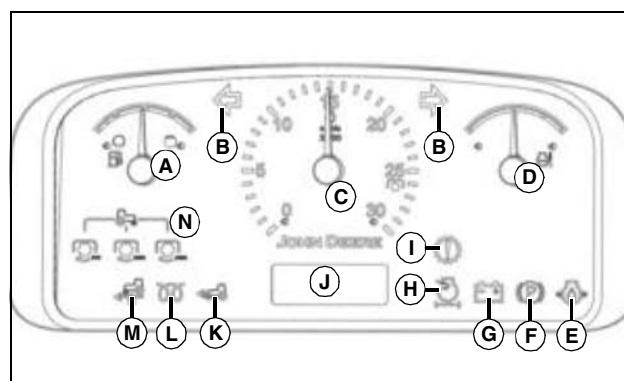

MX22967

A-Fuel Gauge: Shows approximately how much fuel is in

OPERATING - MACHINE

the fuel tank.

B-Warning Flasher/Turn Signal Indicator Light: These indicator lights will turn on and flash when the light switch is turned to one of the two warning flasher positions, or the turn signal switch is in the right or left hand turn position.

C-Tachometer: Shows engine speed in increments of 100 rpm. Example: If indicator is pointing at 20, then 20x100 = 2000 rpm. Note the special PTO marker. At this engine speed, the PTO rotates at the industry standard 540 rpm.

D-Engine Coolant Temperature Gauge: This gauge will indicate the engine coolant temperature. When the needle is approaching or is in the red zone, reduce engine load immediately. Reduce engine rpm to idle speed and check for obstructions blocking airflow to the radiator. Clean grille, and if needle remains in red zone, stop engine immediately. Allow engine to cool, check coolant level, and add coolant if necessary.

E-Engine Oil Pressure Light: This light should flash when the ignition key switch is in the run position and the engine is not running, and also when engine oil pressure is too low with the engine running. If this light flashes while the engine is running, stop engine immediately.

F-Park Brake Light: This light should illuminate when the park brake is set and locked.

G-Alternator/Battery Charging Light: This light should illuminate when the ignition key switch is in the run position and the engine is not running. If this light does illuminate with the engine running, see your John Deere dealer.

H-Air Restriction Indicator: This light will flash if air filter needs servicing.

I-Malfunction Indicator: This light will flash if there is an active error code.

J-Display: This display shows travel speed on some models when the machine starts moving. When the machine stops moving, the display will show the default hour meter. This display shows several functions when scrolled through using the Display Mode Switch:

- **Hour Meter:** This is the default setting. Total number of accumulated running hours. Use the hour meter as a guide when servicing various components of this machine.
- **Machine Travel Speed:** Available on eHydro machines only. Contact your John Deere dealer to change display to mph or kph setting. Travel speed is defaulted to standard tires at the factory. If other tires are installed, contact your John Deere dealer to change to correct tire size for accurate travel speed display.
- **MotionMatch (without optional switch):** Available on eHydro machines only. Display will read “def” when MotionMatch is at factory default settings.
- **LoadMatch:** Available on eHydro machines only. Display

will read “LoadOn” or “LoadOff”.

- **Active Error Codes.** Display will read “Err _ _ _” if any errors are present. See Error Codes in the TROUBLESHOOTING section.

K-MFWD Light: This light will illuminate when Mechanical Front Wheel Drive (MFWD) is activated.

L-Cold Start Indicator Light: Indicates that the ignition key is being pressed in to allow heating of the intake air for faster starting in cold weather.

M-Cruise Control Light: This light will illuminate when the cruise control is active. Cruise control is only on the eHydro model.

N-PTO Engaged Light: These lights will illuminate when the rear and mid-PTO are engaged.

Using Turn Signal Switch

- Push the left side of the turn signal switch down to signal a left turn.
- Push the right side of the turn signal switch down to signal a right turn.

Using Windshield Wiper and Washer

NOTE: Windshield wipers can be parked at any point in the wipe cycle.

Front Wiper

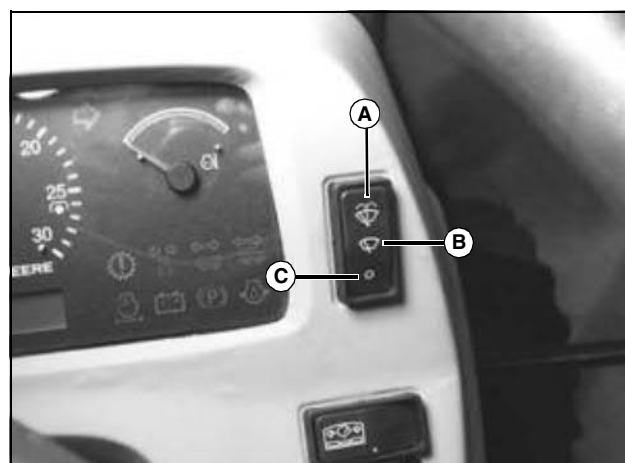

MX35773

Switch has three positions:

- **Top WASH position (A)** - Hold switch down to activate washer.
- **Center ON position (B)** - Window wiper is activated.
- **Bottom OFF position (C).**

OPERATING - MACHINE

Rear Wiper (Optional)

Switch has three positions with same functions as front wiper switch.

Filling Washer Fluid Reservoir

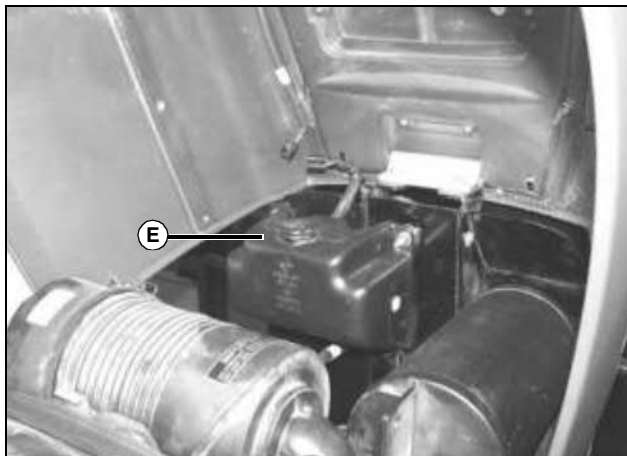

MX35774

Reservoir (E) is located under the hood and to the left of the muffler. Fill reservoir with non-freezing windshield washer fluid.

Using Display Mode Switch

The display mode switch can be used to scroll through hour meter and active error codes display on all machines. On eHydro machines, it can also be used to scroll through travel speed, MotionMatch and LoadMatch functions. The automatic switch of display information will happen as long as the Display Mode Switch is pressed in the current cycle.

Scroll through functions in the normal mode are in the following order:

1. Hour meter will display by default.
2. Press left side of switch once to display travel speed.
3. Press left side of switch again to display MotionMatch setting. If optional MotionMatch switch is installed, the long rollout and short rollout settings are displayed.
4. Press left side of switch again to display LoadMatch setting.
5. If active error codes are present, pressing the switch will scroll through each error code. In the normal mode, if a malfunction occurs, the corresponding error code is displayed and the malfunction indicator light will flash. The error can be acknowledged by pressing the switch.
6. Press left side of switch again to return to hour meter default.

The display mode switch and turn signal switch can be

used together to set MotionMatch. See Using MotionMatch (eHydro) in OPERATING.

Testing Safety Systems

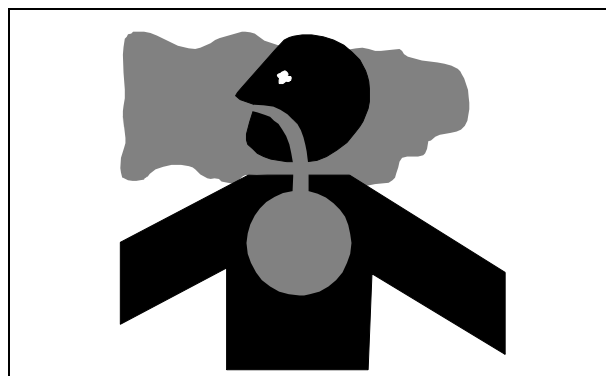

CAUTION: Avoid injury! Engine exhaust fumes contain carbon monoxide and can cause serious illness or death.

Move the machine to an outside area before running the engine.

Do not run an engine in an enclosed area without adequate ventilation.

- **Connect a pipe extension to the engine exhaust pipe to direct the exhaust fumes out of the area.**
- **Allow fresh outside air into the work area to clear the exhaust fumes out.**

The safety systems installed on your machine should be checked before each machine use. Be sure you have read the machine operator manual and are completely familiar with the operation of the machine before performing these safety system checks.

Use the following checkout procedures to check for normal operation of machine.

If there is a malfunction during one of these procedures, do not operate machine. **See your authorized dealer for service.**

Perform these tests in a clear open area. Keep bystanders away.

Testing Neutral Start Switch (PowrReverser)

1. Sit on operator's seat.
2. Lock park brake.

OPERATING - MACHINE

3. Push all PTO engagement knobs to the disengaged/off position.
4. Depress clutch pedal completely and:
 - Move the transmission range shift lever to the N (neutral) position.
 - Move the reverser lever to the forward or reverse position.
5. Turn key switch to start position.
 - Engine must not crank.
6. Turn key switch to off position and move reverser lever to the center N (neutral) position.

Testing Seat Switch (PowrReverser)

1. Sit on operator's seat.
2. Lock park brake.
3. Push all PTO engagement knobs to the disengaged/off position.
4. Depress clutch pedal completely and move the transmission range and gear shift levers into the N (neutral) position.
5. Start machine engine. Set engine speed at 1500 rpm.
6. Depress clutch pedal completely and:
 - Move the transmission gear shift lever to any position other than N (neutral) position.
 - Move the reverser lever to the forward or reverse position.
7. Raise up from operator's seat while depressing clutch pedal completely.
8. Engine should stop.
9. Turn key switch to off position and move transmission gear shift lever to the N (neutral) position.

Testing Rear PTO Knob

1. Sit on operator's seat.
2. Lock park brake.
3. Push all PTO engagement knobs to the disengaged/off position.
4. PowrReverser: Depress clutch pedal completely and move the transmission range and gear shift levers to the N (neutral) position.
5. Move the PTO selector lever to the rear PTO only position.
6. Pull the rear PTO engagement knob to the engaged/on

- position.
7. Turn key switch to start position.
 - Engine must not crank.
 8. Push all PTO engagement knobs to the disengaged/off position.
 9. Turn key switch to off position.

Testing Rear PTO and Seat Switch Interface

1. Sit on operator's seat.
2. Lock park brake.
3. Push all PTO engagement knobs to the disengaged/off position.
4. PowrReverser: Depress clutch pedal completely and:
 - Move the transmission range and gear shift levers into the N (neutral) position.
 - Move the reverser lever to the center neutral position.
5. Start engine.
6. Move the PTO selector lever to the rear PTO only position.
7. PowrReverser: Release clutch pedal.
8. Pull the rear PTO engagement knob to the engaged/on position.
9. Raise up from operator's seat. Do not dismount machine.
10. Engine should stop.
11. Push all PTO engagement knobs to the disengaged/off position.
12. Turn key switch to off position.

Testing Mid-PTO and Seat Switch Interface

1. Sit on operator's seat.
2. Lock park brake.
3. Push all PTO engagement knobs to the disengaged/off position.
4. PowrReverser: Depress clutch pedal completely and:
 - Move the transmission range and gear shift levers into the N (neutral) position.
 - Move the reverser lever to the center neutral position.
5. Start engine. Set engine speed at 1500 rpm.
6. PowrReverser: Release the clutch.
7. Move the PTO selector lever to the mid-PTO only position.

OPERATING - MACHINE

8. Pull the mid-PTO knob to the engaged/on position.
9. Raise up from operator's seat. Do not dismount machine.
10. Engine should stop.
11. Push all PTO engagement knobs to the disengaged/off position.
12. Start engine. Set engine speed at 1500 rpm.
13. Move the PTO selector lever to the mid and rear PTO position.
14. Pull the PTO engagement knob to the engaged/on position.
15. Raise up from operator's seat. Do not dismount machine.
16. Engine should stop.
17. Push all PTO engagement knobs to the disengaged/off position.
18. Turn key switch to off position.

Testing Rear PTO and Park Brake Interface

1. Sit on operator's seat.
2. Lock park brake.
3. Push all PTO engagement knobs to the disengaged/off position.
4. PowrReverser: Depress clutch pedal completely and:
 - Move the transmission range and gear shift levers into the center N (neutral) position.
 - Move the reverser lever to the center neutral position.
5. Start machine engine. Set engine speed at 1500 rpm.
6. PowrReverser: Release clutch pedal.
7. Raise up from operator's seat. Do not dismount machine.
8. Pull the rear PTO engagement knob to the engaged/on position.
 - Rear PTO should operate.
9. Rear PTO should operate.
10. Unlock park brake.
11. Engine should stop.
12. Push all PTO engagement knobs to the disengaged/off position.
13. Turn key switch to off position.

Using Fuel Shut-Off Valve

Close the valve when performing any type of engine

service, during transport of the machine, and during storage.

1. Locate the fuel shut-off valve on the right side of the machine on the fuel sediment filter.

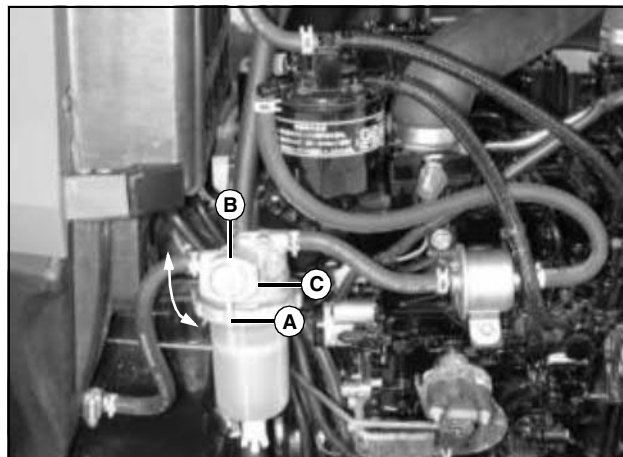

MX21816

2. Open or close fuel shut-off valve lever (A) as required:
 - **Open Valve:** Rotate valve lever to the "O" (vertical) position (B).
 - **Close Valve:** Rotate valve lever to the "S" (horizontal) position (C).

OPERATING - MACHINE

Using Brake Pedals (PowrReverser)

Using Brake Pedals As Driving Brake:

- CAUTION:** Avoid injury! Using unlocked brakes to stop the machine at high speeds may cause accidental turning or tipping.
- Lock pedals together when not using the turn brakes or for road travel or transport.
 - Slow down before making a turn.

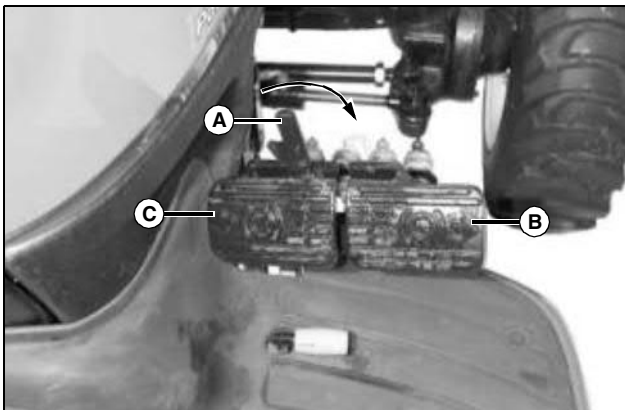

MX20924

1. Rotate brake pedal latch (A) clockwise until it locks into right turn brake pedal (B).
2. Depress either brake pedal to slow or stop the machine.
 - With latch down, brakes should stop machine in a straight line.

Using Brake Pedals to Assist In Turning:

IMPORTANT: Avoid damage! Do not apply turn brakes while an implement is engaged with the ground. Damage to the 3-point hitch and implement may occur.

NOTE: Turn brake pedals can be used to make tighter turns and may reduce unnecessary backing.

1. Rotate brake pedal latch (A) counterclockwise until it stops against left turn brake pedal (C). The brake pedals will now function independently.
 - To make a tighter left turn, depress left turn brake pedal (C) while turning to the left.
 - To make a tighter right turn, depress right turn brake pedal (B) while turning to the right.

Using Brake Pedals (eHydro)

Using Brake Pedals As Driving Brake:

- CAUTION:** Avoid injury! Using unlocked brakes to stop the machine at high speeds may cause accidental turning or tipping.
- Lock pedals together when not using the turn brakes or for road travel or transport.
 - Slow down before making a turn.

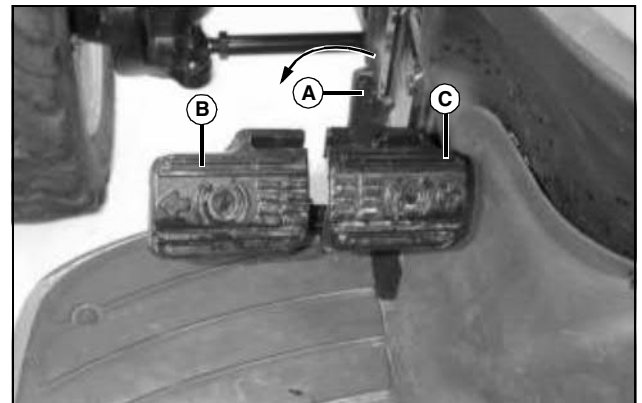

MX20925

Picture Note: Tractor without cab shown.

1. Rotate brake pedal latch (A) counterclockwise until it locks into left turn brake pedal (B).
2. Depress either brake pedal to slow or stop the machine.
 - With latch down, brakes should stop machine in a straight line.

Using Brake Pedals to Assist In Turning:

IMPORTANT: Avoid damage! Do not apply turn brakes while an implement is engaged with the ground. Damage to the 3-point hitch and implement may occur.

NOTE: Turn brake pedals can be used to make tighter turns and may reduce unnecessary backing.

1. Rotate brake pedal latch (A) clockwise until it stops against right turn brake pedal (C). The brake pedals will now function independently.
 - To make a tighter left turn, depress left turn brake pedal (B) while turning to the left.
 - To make a tighter right turn, depress right turn brake pedal (C) while turning to the right.

OPERATING - MACHINE

Using Park Brake

Locking Park Brake:



CAUTION: Avoid injury! Always lock park brake and move transmission range shift lever to a position other than N (neutral) before leaving machine unattended. Transmissions will not prevent machine motion without the park brake locked.

1. Lock both brake pedals together using brake pedal latch.
2. Press down on brake pedals with foot.
3. Tractors without Cabs:
 - Pull park brake lever up to the locked position. Park brake light should illuminate.
4. Tractors with Cabs:
 - Pull park brake knob out to the locked position. Park brake light should illuminate.
5. Remove foot from brake pedals.

Unlocking Park Brake:

1. Press down on brake pedals with foot.
2. Tractors without Cabs:
 - Pull up slightly on park brake lever while depressing the release button. Push park brake lever down to the unlocked position. Park brake light should be off.
3. Tractors with Cabs:
 - Push park brake knob in to the unlocked position. Park brake light should be off.
4. Remove foot from brake pedals. Both pedals should now be released from the locked position.

Using Throttle Controls

Hand Throttle Operation

Use the hand throttle lever to set a constant engine speed for stationary operation (all models) or for field operation such as tillage (PowrReverser only).

- **Decrease Engine Speed** - Pull hand throttle lever down.
- **Increase Engine Speed** - Push hand throttle lever up.

Foot Throttle Operation (PowrReverser Only)

Use the foot throttle to temporarily override/increase the hand throttle lever setting when the machine operation requires repeated engine speed change, such as when operating a loader.

1. Set the hand throttle lever at middle operating rpm.
2. Depress the foot throttle to increase rpm and machine speed.
3. Release the foot throttle to return engine speed to the previously-set hand throttle lever position.

Starting the Engine



CAUTION: Avoid injury! Engine exhaust fumes contain carbon monoxide and can cause serious illness or death.

Move the machine to an outside area before running the engine.

Do not run an engine in an enclosed area without adequate ventilation.

- **Connect a pipe extension to the engine exhaust pipe to direct the exhaust fumes out of the area.**
- **Allow fresh outside air into the work area to clear the exhaust fumes out.**

NOTE: It is recommended to install optional engine block heater and hydraulic oil heater if operating machine in temperatures below -18° C (0° F).

If temperature is below 0° C (32° F), follow the cold weather starting steps in this section.

1. Lock the park brake.
2. Push all PTO engagement knobs to the disengaged/off position.
3. Move transmission to neutral position:
 - PowrReverser: Depress clutch pedal completely and move the transmission gear lever and reverser lever to the N (neutral) position.
 - eHydro: Remove foot from forward and reverse travel pedals.



CAUTION: Avoid injury! Check to be sure area is clear of any bystanders before lowering implements to the ground.

4. Lower any rear mount or mid mount implement to the ground by pushing the rockshaft control lever forward.
5. Lower any front mounted implement to the ground using the SCV lever.
6. Set hand throttle lever to the 1/3 fast position.
7. Turn ignition key switch to the run position.

OPERATING - MACHINE

8. Check instrument panel indicator lights:
 - Alternator/battery charging light will illuminate.
 - Park brake light will illuminate if park brake is locked.
 - Engine oil pressure light will flash.
9. For cold weather starting, use the intake air heater system. Activate the intake air heater system by pushing in the ignition key switch with the key, and holding it there for the required time:
 - 10 - 15 seconds for temperatures as low as -18°C (0°F).
 - 15 - 30 seconds for temperatures below -18°C (0°F).

IMPORTANT: Avoid damage! Starter may be damaged if starter is operated for more than 20 seconds at a time:

- **Wait two minutes before trying again if engine does not start.**

10. Turn key switch to the start position. Release key when engine starts.
11. Check instrument panel indicator lights:
 - Engine oil pressure light should go out within 5 seconds.
 - Alternator/battery charging light should go out within 10 seconds.
12. Set engine speed at full throttle if indicator light does not go out after 10 seconds. If indicator light continues to stay on, stop the engine and check for cause.

IMPORTANT: Avoid damage! In cold weather, run engine several minutes to allow engine oil and transmission oil to warm.

NOTE: It is normal for the engine to be louder and for blue-white exhaust smoke to be present during engine warm-up. The amount of exhaust smoke depends on air temperature.

13. Warm the engine:
 - In warm weather, set hand throttle lever to the 1/2 fast position for 1 minute without load.
 - In cold weather, set hand throttle lever to the 1/2 fast position for 5 minutes without load.

Idling the Engine

NOTE: Allowing engine to idle for long periods of time will waste fuel and cause carbon build-up.

1. Adjust hand throttle lever to set engine speed at slow idle speed.

2. Lock the park brake.

Starting a Stalled Engine

IMPORTANT: Avoid damage! If engine stalls while operating under load, start engine immediately to prevent abnormal heat build-up in engine.

1. Push all PTO engagement knobs to the disengaged/off position.
2. Move transmission to neutral position:
 - PowrReverser: Depress clutch pedal completely and move the transmission gear lever and reverser lever to the N (neutral) position.
 - eHydro: Remove foot from forward travel and reverse travel pedals.
3. Start engine. Continue with normal operation, or set engine at slow idle speed for 2 minutes before stopping the engine.

Stopping the Machine

Normal Stopping

1. Position the machine on a firm, level surface.
2. Stop machine motion:
 - PowrReverser: Depress clutch pedal completely and depress both brake pedals.
 - eHydro: Remove foot smoothly from forward or reverse travel pedals to stop motion.
3. Move transmission to neutral position:
 - PowrReverser: Depress clutch pedal completely and move the transmission gear lever and reverser lever to the N (neutral) position.
4. Push all PTO engagement knobs to the disengaged/off position.



CAUTION: Avoid injury! Check to be sure area is clear of any bystanders before lowering implements to the ground.

5. Lower any rear mount or mid-mount implement to the ground by pushing the rockshaft control lever forward.
6. Lower any front mounted implement to the ground using the SCV lever.

OPERATING - MACHINE

IMPORTANT: Avoid damage! Do not stop engine immediately after hard or extended operation. Keep engine running at low idle for about 2 minutes to prevent heat build-up.

7. Adjust hand throttle lever to set engine at slow idle speed. Allow engine to idle for 2 minutes.



CAUTION: Avoid injury! Always lock park brake and move transmission range shift lever to a position other than N (neutral) before leaving machine unattended. Transmissions will not prevent machine motion without the park brake locked.

8. Lock the brake pedals together using the brake pedal latch.

9. Lock the park brake.

10. Turn ignition key switch to the off position.

11. Remove the key.

12. Wait for the engine and all moving parts to stop before leaving the operator's station.

Emergency Stopping (PowrReverser)

1. Depress clutch pedal all the way down and depress both brake pedals.

2. Turn key switch to off position. Do not release clutch pedal until all moving parts have stopped.

3. If possible, lock the park brake.

Emergency Stopping (eHydro)

1. Remove foot from forward or reverse travel pedals.

2. Depress both brake pedals.

3. Turn key switch to off position. Do not release brake pedals until all moving parts have stopped.

4. If possible, lock the park brake.

Operating PowrReverser Transmission

The range shift lever provides three speed ranges. The gear shift lever provides four gear positions. The reverser lever controls travel direction.

Use all three levers in different combinations to achieve twelve forward and twelve reverse speeds.

Machine motion must stop and the clutch pedal must be depressed before changing ranges. Gears may be changed while machine is in motion if clutch pedal is completely depressed.

IMPORTANT: Avoid damage! Select the proper speed range and gear for the job:

- Never overload engine by lugging machine at low idle speeds.

- Raise engine speed to match expected loads. If a slight increase in engine rpm occurs simultaneously with moving hand throttle lever forward, the engine is not overloaded.

1. Choose a speed range to match work application:

- A – Low speed/high power operations such as tilling hard soil, mowing high grass or positioning backhoe.
- B – Operations including moderate tilling, hauling, and grass mowing.
- C – High speed operations such as transport and light mowing.

2. Choose a gear that matches the immediate power/speed requirements:

- 1st Gear – High power, low speed operations.
- 2nd Gear – Medium power, moderate speed operations.
- 3rd Gear – Low power, moderate speed operations.
- 4th Gear – Low power, high speed operations.

Driving Machine (PowrReverser)



CAUTION: Avoid injury! Always check area around machine for bystanders and obstacles before operating the machine.

IMPORTANT: Avoid damage! To prevent transmission damage:

- Depress clutch pedal and stop machine motion completely before shifting the range lever.

- Always depress clutch pedal when shifting the gear lever.

- Never rest a foot on the clutch pedal while machine is in motion.

1. Start machine engine.

2. Move reverser lever to neutral position.

3. Unlock park brake.

4. Depress clutch pedal completely.

5. Choose A, B, or C speed range on transmission range shift lever to match work application.

OPERATING - MACHINE

6. Move the transmission gear shift lever to the desired gear position.
7. Move the reverser lever to the forward or reverse position.
8. Release clutch pedal gradually to take up load smoothly.
9. Continue to shift gears while moving under normal loads:
 - Depress clutch pedal completely and shift to next gear.
 - Release clutch pedal gradually to take up load smoothly.
10. Adjust throttle speed:
 - To maintain a constant operating speed, adjust the engine speed with the hand throttle lever.
 - To repeatedly increase and decrease engine speed, leave the hand throttle lever set at the middle position and use the foot throttle to change engine speed.

CAUTION: Avoid injury! Always check area around machine for bystanders and obstacles before repositioning machine or changing machine direction.

11. To change travel direction:
 - Clutch use is not required.
 - Move the reverser lever to the forward or reverse position.

Travel Speeds

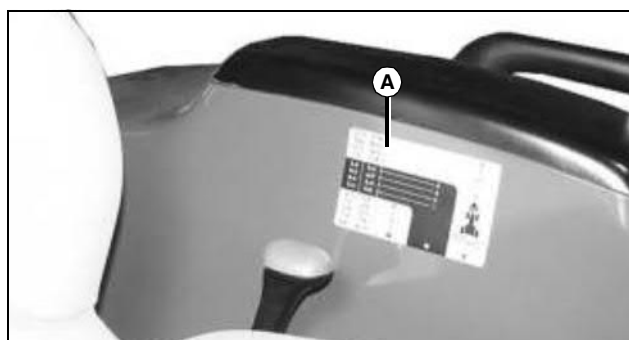

MX32736

The ground speed label (A) located on the left fender can be used to determine your travel speed.

If the tire size on your machine is within the range indicated on the label, and you are traveling with the engine speed at the rpm indicated on the label, the approximate travel speed for each range and/or gear is shown.

Operating eHydro Transmission

The range shift lever provides three speed ranges.

The range shift lever is used in conjunction with the forward and reverse travel pedals.

IMPORTANT: Avoid damage! Select the proper speed range and gear for the job:

- **Never overload engine by lugging machine at low idle speeds.**
- **Raise engine speed to match expected loads. If a slight increase in engine rpm occurs simultaneously with moving hand throttle lever forward, the engine is not overloaded.**

1. Choose a speed range to match work application.
 - A – Low speed/high power operations such as tilling hard soil, mowing high grass or positioning backhoe.
 - B – Operations including moderate tilling, hauling, and grass mowing.
 - C – High speed operations such as transport and light mowing.

Driving Machine (eHydro)

CAUTION: Avoid injury! Always check area around machine for bystanders and obstacles before operating the machine.

IMPORTANT: Avoid damage! To prevent transmission damage, stop machine motion completely before shifting the range shift lever.

1. Start machine engine.
2. Unlock park brake.
3. Choose A, B, or C speed range on transmission range shift lever to match work application.
4. Move hand throttle lever to desired operating speed.
5. Slowly depress forward pedal downward to travel forward. Slowly depress reverse pedal downward to travel in reverse.
 - The farther either travel pedal is depressed, the faster the machine will travel.
6. Release travel pedal to stop machine and change speed range.
7. Fully stop machine motion before turning off ignition.

OPERATING - MACHINE

Travel Speeds

Travel speed is displayed on your machine instrument panel. See Using Display Mode Switch in the OPERATING section.

Using Cruise Control (eHydro With Standard Cruise Control)



CAUTION: Avoid injury! Use cruise control only in large, open areas. Shut off before turning or when in areas with many obstacles.

NOTE: The cruise control is only operational when the machine is traveling forward.

Engaging Cruise Control

1. Depress forward travel pedal until desired travel speed is reached.
2. Fully depress top of cruise control switch to engage cruise control.
 - Instrument panel cruise control indicator light will illuminate when cruise control is activated.
3. Release forward travel pedal.
4. To adjust travel speed, disengage cruise control and engage cruise control again at a different speed.

Disengaging Cruise Control

NOTE: The machine will stop if cruise control is disengaged while the machine is in motion. To maintain forward motion, depress the forward travel pedal before disengaging cruise control.

1. Fully depress bottom of cruise control switch, or depress the right brake pedal.
 - Instrument panel cruise control indicator light should go out when the cruise control is disengaged.

Using Cruise Control (eHydro With Automotive Cruise Control Option)



CAUTION: Avoid injury! Use cruise control only in large, open areas. Shut off before turning or when in areas with many obstacles.

NOTE: The cruise control is only operational when the machine is traveling forward.

Engaging Cruise Control

1. Depress forward travel pedal until desired travel speed is reached.
2. Fully depress top of cruise control switch to engage cruise control.
3. Fully depress bottom of Res/Set switch.
 - Instrument panel cruise control indicator light will illuminate when cruise control is activated.
4. Release forward travel pedal.
5. Adjust maximum travel speed:
 - Fully depress top of accel/decel switch repeatedly to increase speed by increments.
 - Fully depress bottom of accel/decel switch repeatedly to decrease speed by increments.

NOTE: Machine must be moving forward, not stopped, for resume function to operate.

6. Fully depress top of accel/decel switch to resume cruise speed after cruise control has been disengaged.

Disengaging Cruise Control

NOTE: The machine will stop if cruise control is disengaged while the machine is in motion. To maintain forward motion, depress the forward travel pedal before disengaging cruise control.

1. Fully depress bottom of cruise switch to return switch to middle position, or depress the right brake pedal.
 - Instrument panel cruise control indicator light should go out when the cruise control is disengaged.

Using SpeedMatch Option (eHydro)

SpeedMatch enables the operator to set the desired maximum travel speed for the machine. Full forward or reverse pedal travel distance can be used to control machine travel speed between stop and the desired maximum travel speed.

1. Depress forward travel pedal until desired maximum travel speed is reached.
2. Fully depress bottom of cruise switch to activate speedmatch function.
3. Fully depress bottom of accel/decel switch to set maximum travel speed.
4. Release forward travel pedal. Completely depress forward travel pedal to achieve desired maximum speed.
5. Adjust maximum travel speed:
 - Fully depress top of accel/decel switch repeatedly to increase speed by increments.

OPERATING - MACHINE

- Fully depress bottom of accel/decel switch repeatedly to decrease speed by increments.

6. Fully depress top of cruise switch to return switch to middle position and disengage speedmatch.

Using MotionMatch (eHydro)

MotionMatch enables the operator to adjust machine acceleration and deceleration rates. Shorter starting and stopping distances can be set for applications requiring rapid changes in direction, such as operating with a loader. Longer starting and stopping distances can be set to avoid turf damage in other applications.

A MotionMatch setting of 1 is the shortest rolling (starting/stopping) distance, and a setting of 9 is the longest rolling (starting/stopping) distance.

1. Fully depress top of MotionMatch™ switch for quicker acceleration/deceleration response levels, and to reduce machine starting/stopping distances.
2. Fully depress bottom of MotionMatch switch for slower acceleration/deceleration response levels, and to increase machine starting/stopping distances.

Changing MotionMatch Setting

1. Press and hold the display mode switch until the display reads “Release”.
2. Release the display mode switch and display should read “Coast”.
3. Press the display mode switch once again.
4. For machines without MotionMatch switch:
 - a. Push the turn signal switch and return to neutral position to change to desired setting between 1 and 9. Position 5 is displayed as “DEF”, the factory default.
5. For machines with MotionMatch switch:
 - a. Push the turn signal switch and return to neutral position to change to desired setting between 5 and 9. Position 5 is displayed as “LONG_D”, the factory default.
 - b. Push the turn signal switch and return to neutral position to change to desired setting between 1 and 5. Position 5 is displayed as “SHRT_D”, the factory default.
6. To confirm the changes for MotionMatch setting, press display mode switch once again.

Using LoadMatch (eHydro)

LoadMatch enables the operator to prevent the engine stalling during heavy load applications such as operating with a loader. This feature is turned on and off using the

display mode switch

1. Turn key switch to ON position.
2. No error codes should be displayed. If any errors are displayed, activate the display mode switch (A) to acknowledge the error.
3. Press and hold the display mode switch (A) until the display reads “rELEAS”.
4. The last edited command will display, either Coast or Load.
5. If Load is not displayed, use left or right turn signals to select the Load command.
6. Activate the display mode switch (A) to edit the LoadMatch setting.
7. The LCD (B) will display the last setting for LoadMatch, either On or Off.
8. Activate the left or right turn signals (C) to turn LoadMatch On or Off.
9. When the desired setting is displayed, activate the display mode switch (A) to store the setting.
10. The LCD (B) will flash the entered command twice and then change to the normal mode.

Using Differential Lock (Traction Assist)



CAUTION: Avoid injury! Driving at high speeds with the traction assist engaged may result in loss of steering control. Do not engage traction assist or turn with the traction assist engaged while operating machine at high speeds or on slopes.

The differential lock is used to provide better traction when the rear wheels start to slip. Engaging the differential lock will lock the right and left side rear axles together and cause both rear wheels to turn at equal speeds for maximum traction.

IMPORTANT: Avoid damage! Using the traction assist function improperly can damage the transaxle:

- Reduce speed and allow drive wheels to rotate at same speed before engaging or disengaging traction assist.
- Disengage traction assist when driving on dry asphalt or concrete.
- Use traction assist only when necessary for improved ground engagement.

OPERATING - MACHINE

NOTE: Turning radius is increased when the differential lock is engaged. To assist turning, release the differential lock and use the turn brake pedals.

Engaging Differential Lock

1. Stop or slow machine movement.

NOTE: Differential lock will remain engaged as long as rear wheel slippage occurs. If tires slip and regain traction repeatedly, hold down pedal with foot so differential lock remains engaged.

2. Push down on differential lock pedal to engage differential lock.

Disengaging Differential Lock

1. Remove foot from differential lock pedal.

NOTE: Rear wheel slippage will keep differential lock engaged. Lock will automatically disengage when traction equalizes.

2. If lock does not disengage when foot is removed from pedal, depress one turn brake pedal and then the other.

Using Mechanical Front Wheel Drive (MFWD)

Mechanical front wheel drive (MFWD) enables the powertrain to drive both front and rear axles for improved traction on difficult ground conditions and provides 4-wheel braking. MFWD can be engaged and disengaged on-the-go with light loads and on low traction surfaces.



CAUTION: Avoid injury! Use extra caution when driving on slopes. To increase traction and provide four-wheel braking, engage mechanical front wheel drive (MFWD) when driving on slopes. Be aware that MFWD can improve access to dangerously sloped terrain, thereby increasing the possibility of tipover.

To improve braking on sloped, icy, wet, or graveled surfaces, engage the MFWD. Add ballast to the tractor and travel at a reduced speed to avoid skidding and loss of steering control.

IMPORTANT: Avoid damage! Always disengage MFWD when driving on a paved surface.

Put the transmission levers in neutral to move the machine when the engine is not running.

1. Pull up on MFWD lever to engage MFWD.
 - Instrument panel MFWD light will illuminate when MFWD is activated.

NOTE: It may be necessary to reduce engine load to disengage front wheel drive.

2. Push down MFWD lever to disengage MFWD.

Tips for Operating MFWD:

- Maintain front tire pressure at maximum allowable level to ensure proper tire performance in all field conditions.
- Engage MFWD to provide four-wheel braking.
- Disengage MFWD when driving machine to or from work site to increase front tire life.

Using the Power-Take-Off (PTO) Safely

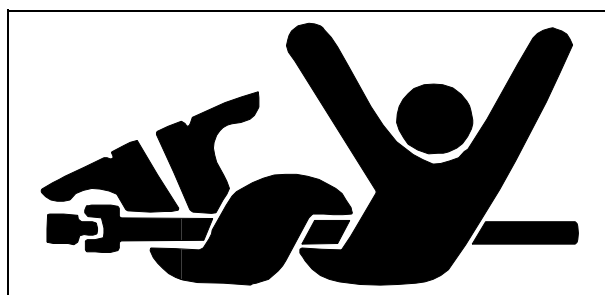

CAUTION: Avoid injury! Stay clear of rotating drivelines:

- Entanglement in rotating driveline can cause serious injury or death.
- Keep hands, feet and clothing away.
- Make sure that all shields are installed and used properly.
- Stop the engine and be sure PTO driveline is stopped before getting near it.

Using Rear and Mid-PTO (Operator on Seat)

NOTE: The mid-PTO is available as optional equipment, and is only operational with the operator on the seat.

NOTE: The PTO selector lever has three operating positions:

- Top (tractors without a cab) or rearward (for tractors with a cab) for rear PTO only.
- Bottom (tractors without a cab) or forward (for tractors with a cab) for mid-PTO only.
- Center for both rear and mid-PTO at the same time.

OPERATING - MACHINE

Engaging Rear PTO Only

1. Sit on operator's seat.
2. Stop machine motion and:
 - PowrReverser model: Move the reverser lever to neutral position, and push all PTO engagement knobs to the disengaged/off position.
 - eHydro model: Remove foot from forward and reverse travel pedals, and push all PTO engagement knobs to the disengaged/off position.

NOTE: The starter will not crank if the rear/mid PTO knob is pulled to the engaged/on position. If the operator leaves the seat with the engine running and the rear/mid PTO engaged, the safety interlock system will stop the engine and all implements.

3. Reduce throttle setting to 1500 rpm.
4. Move the PTO selector lever to top/rearward position for rear PTO only.
5. Pull the rear PTO engagement knob to the engaged/on position to engage the rear PTO.
 - The instrument panel PTO engaged light will illuminate when the rear PTO is engaged.
6. Adjust the hand throttle lever forward to the desired speed for implement used.

NOTE: The PTO marker on the tachometer indicates engine speed for a standard 540 PTO.

Disengaging Rear PTO

1. Adjust engine rpm to low idle.
2. Push all PTO engagement knobs to the disengaged/off position to disengage the rear PTO.
 - The instrument panel PTO engaged light will go out when the rear PTO is disengaged.

Engaging Mid-PTO Only

1. Sit on operator's seat.
2. Stop machine motion and:
 - PowrReverser model: Move the reverser lever to neutral position.
 - eHydro model: Remove foot from forward and reverse travel pedals.
3. Push all PTO engagement knobs to the disengaged/off position.

NOTE: The starter will not crank if the rear/mid PTO engagement knob is pulled to the engaged/on position. If the operator leaves the seat with the engine running and the rear PTO engaged, the safety interlock system will stop the engine and all implements.

4. Reduce throttle setting to 1500 rpm.

NOTE: The PTO selector lever has three operating positions:

- **Top (tractors without a cab) or rearward (for tractors with a cab) for rear PTO only.**
- **Bottom (tractors without a cab) or forward (for tractors with a cab) for mid-PTO only.**
- **Center for both rear and mid-PTO at the same time.**

5. Move the PTO selector lever to bottom/forward position for mid-PTO only.
6. Pull the mid-PTO engagement knob to the engaged/on position.
 - The instrument panel PTO engaged light will illuminate when the mid-PTO is engaged.
7. Adjust the hand throttle lever forward to the desired speed for implement used.

NOTE: The PTO marker on the tachometer indicates engine speed for a standard 540 PTO. At 540 rpm rear PTO, mid-PTO speed will be 2100 rpm.

Disengaging Mid-PTO

1. Adjust engine rpm to low idle.
2. Push the mid-PTO engagement knob to the disengaged/off position to disengage the mid-PTO.
 - The instrument panel PTO engaged light will go out when the mid-PTO is disengaged.

Engaging Both Rear PTO and Mid-PTO at Same Time

1. Sit on operator's seat.
2. Stop machine motion and:
 - PowrReverser model: Move the reverser lever to neutral position.
 - eHydro model: Remove foot from forward and reverse travel pedals.
3. Push all PTO engagement knobs to the disengaged/off position.

NOTE: The starter will not crank if the PTO engagement knob is pulled to the engaged/on position. If the operator leaves the seat with the engine running and the rear PTO engaged, the safety interlock system will stop the engine and all implements.
4. Reduce throttle setting to 1500 rpm.

OPERATING - MACHINE

5. Move the PTO selector lever to center position to operate both rear PTO and mid-PTO at the same time.

6. Pull the PTO engagement knob to the engaged/on position.

- Two instrument panel PTO engaged lights will illuminate when both PTO's are engaged.

7. Adjust the hand throttle lever forward to the desired speed for implement used.

NOTE: The PTO marker on the tachometer indicates engine speed for a standard 540 PTO. At 540 rpm rear PTO, mid-PTO speed will be 2100 rpm.

Using Rear PTO (Operator off Seat)

NOTE: The rear PTO can be engaged with the operator off the seat. The Safety Interlock System will stop the engine and all implements if the mid-PTO is engaged and the operator gets off the seat.

NOTE: The PTO selector lever has three operating positions:

- **Top (tractors without a cab) or rearward (for tractors with a cab) for rear PTO only.**
- **Bottom (tractors without a cab) or forward (for tractors with a cab) for mid-PTO only.**
- **Center for both rear and mid-PTO at the same time.**

Engaging Rear PTO

1. Sit on operator's seat.

2. Move transmission to neutral position:

- **PowerReverser:** Depress clutch pedal completely and move the transmission gear and range shift levers and the reverser lever to the N (neutral) position.
- **eHydro:** Move the range shift lever to the N (neutral) position.

3. Lock park brake.

4. Push all PTO engagement knobs to the disengaged/off position.

NOTE: The starter will not crank if the rear/mid PTO engagement knob is pulled to the engaged/on position.

5. Start the engine and adjust speed to 1500 rpm.

6. Move the PTO selector lever to top/rearward position for rear PTO only.

7. Get off the operator's seat.

8. Pull the rear PTO engagement knob to the engaged/on position to engage the rear PTO.

- The engine should continue to run.

- The instrument panel PTO engaged light will illuminate when the rear PTO is engaged.

9. Adjust the hand throttle lever forward to the desired speed for implement used.

NOTE: The PTO marker on the tachometer indicates engine speed for a standard 540 PTO.

Disengaging Rear PTO

1. Adjust engine rpm to low idle.

2. Push all PTO engagement knobs to the disengaged/off position.

- The instrument panel PTO engaged light will go out when the rear PTO is disengaged.

Using Drawbar Hitch



CAUTION: Avoid injury! Use only the drawbar that was provided with the machine (if equipped), or the optional drawbar available from your John Deere Dealer. Do not install or use any other type drawbar.

To avoid rearward upset, all towed loads must be attached to the drawbar, not just to the center link or draft arms.

IMPORTANT: Avoid damage! Maximum static vertical load on drawbar should not exceed the maximum recommendations. Drive slowly with heavy loads.

Maximum Drawbar Loads

Certain heavy equipment such as a loaded single-axle trailer can place excessive strain on the drawbar. Strain is greatly increased by speed and rough ground. Do not exceed the maximum static vertical load in the SPECIFICATIONS section.

Adjusting Drawbar Length

IMPORTANT: Avoid damage! For drawn PTO-driven implements, the drawbar must be in the operating position.

The drawbar is equipped with two adjusting holes for changing drawbar length and one hole for storage.

OPERATING - MACHINE

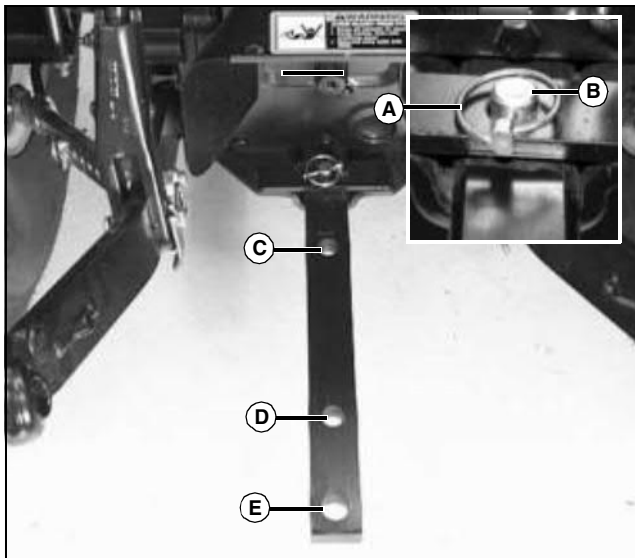

MX5227, M63801

1. Remove quick-lock pin (A) and drilled pin (B).
2. Adjust drawbar to operating position (C) or (D), or to storage position (E).
3. Install drilled pin (B) up from bottom of machine. Secure with quick-lock pin (A).

Using 3 Point Hitch

NOTE: The 3-point hitch on your machine is classified as a Category 1 hitch.

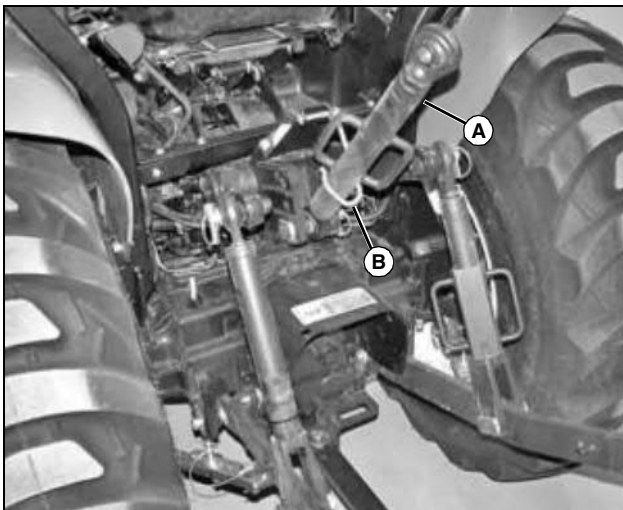

MX26261

- Place center link (A) in storage hook (B) when the hitch is not in use.

Positioning Center Link

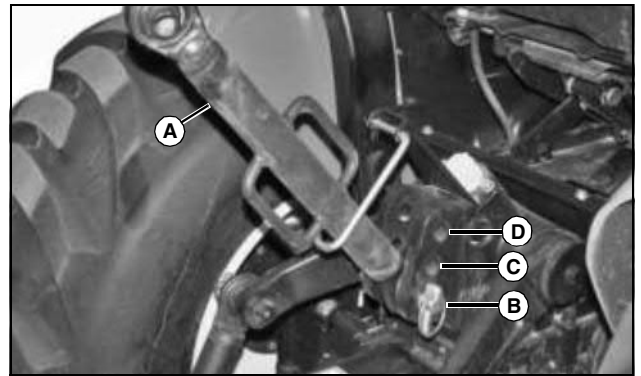

MX26262

- **For light and medium draft loads:** Install center link (A) in bottom hole (B) of mounting bracket. Example of light and medium draft load implements would include a landscape rake.
- **For medium and heavy draft loads:** Install center link in middle hole (C) of mounting bracket. Example of medium and heavy draft load implements would include a tiller or box blade.
- **For very heavy draft loads:** Install center link in top hole (D) of mounting bracket. Example of very heavy draft load implements would include a plow or ripper.

Using Rockshaft Control Lever

Use rockshaft control lever to raise and lower equipment attached to the 3-point hitch.

The six calibrated settings are for reference only and do not signify specific operating depths. When the rockshaft control lever is moved forward, the draft arms will lower closer to the ground.

Lower Implement: Push rockshaft control lever forward.

Raise Implement: Pull rockshaft control lever rearward.

The adjustable depth stop can be adjusted to maintain a particular implement operating depth. To use the depth stop knob:

1. Operate implement for a few minutes to determine the desired operating depth.
2. Loosen the depth stop knob.
3. Move knob against rockshaft control lever.
4. Tighten knob to keep the depth stop in position. Implement will operate in same position each time rockshaft control lever is pushed against the depth stop.

OPERATING - MACHINE

Using Rate of Drop/Lock Valve

CAUTION: Avoid injury! Excessive rate-of-drop may cause injury or damage. Fully lowering implement should take at least 2 seconds.

IMPORTANT: Avoid damage! To prevent overheating hydraulic oil and damaging machine, do not raise rockshaft when drop/lock valve is closed.

The rate of drop/lock valve controls the rate of rockshaft drop when the rockshaft control lever is operated. This provides direct rate of drop control for 3-point hitch mounted implements. The valve can also be used to hydraulically lock the rockshaft (three-point hitch) in a desired position.

Increase Rate of Drop: Rotate drop/lock valve knob counter-clockwise to make drop faster.

Decrease Rate of Drop: Rotate drop/lock valve knob clockwise to make drop slower.

CAUTION: Avoid injury! Do not use the rockshaft drop/lock valve for holding an attachment in raised position for service work. Loss of hydraulic pressure could result in sudden drop of attachment. Lower attachment onto blocks or remove from machine before servicing.

Lock 3-Point Hitch: Rotate drop/lock valve knob clockwise until tight.

Unlock 3-Point Hitch: Rotate drop/lock valve knob counter-clockwise.

Using Draft Links

CAUTION: Avoid injury! Look down and behind before and while backing. Clear area of all bystanders before backing machine.

1. Slowly back machine into position to align draft links with implement lift brackets.

2. Park machine safely. (See Parking Safely in the SAFETY section.)

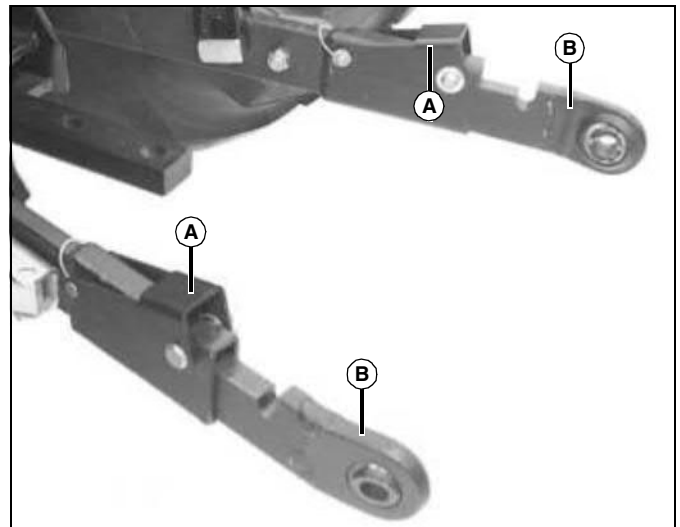

MX5091

3. For machines equipped with optional telescoping draft links: Raise locking lever (A) and pull link (B) to extend as needed.

4. Connect draft links to the implement.

CAUTION: Avoid injury! Fingers and hands can be pinched or crushed. Be aware of potential pinch points and keep hands away.

IMPORTANT: Avoid damage! Telescoping draft link locking levers must be in locked position before operating the machine or link damage could occur.

5. For machines equipped with optional telescoping draft links:

- Sit on operator's seat and start engine.
- Back machine until each lock lever snaps and secures each draft link in the locked position.

Leveling Implement Front-to-Rear

Leveling a 3-point hitch mounted implement front-to-rear is accomplished by adjusting the length of the center link:

1. Park machine safely. (See Parking Safely in the Safety section.)

OPERATING - MACHINE

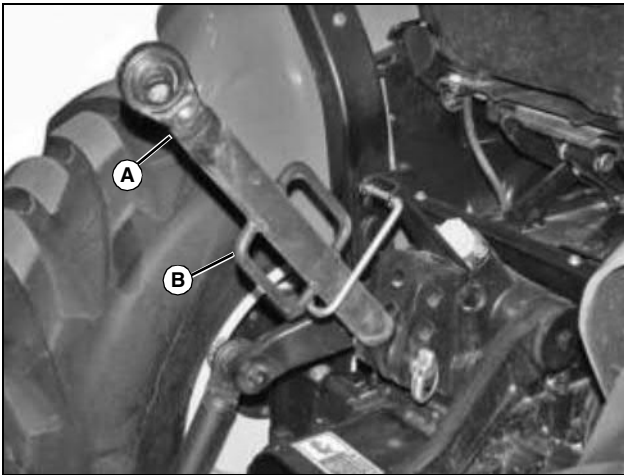

MX26262

2. Loosen locknut (A).

IMPORTANT: Avoid damage! Do not turn center link body past the stops, or threads may be damaged.

3. Rotate handle (B) to lengthen or shorten the center link.
4. Tighten locknut (A).

Leveling Implement Side-to-Side



MX26261

Use turn handle (A) on the right adjustable lift link (B) to level a 3-point hitch implement side-to-side.

1. Park machine safely. (See Parking Safely in the Safety section.)

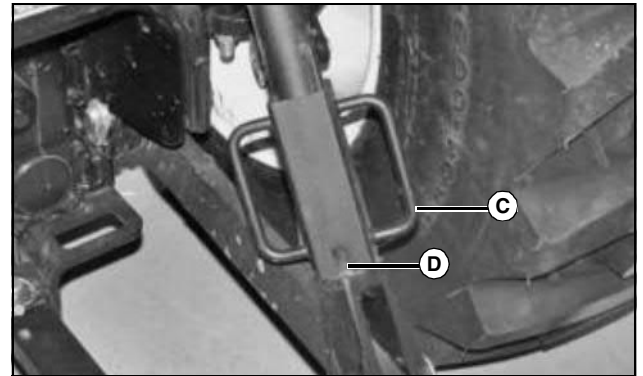

MX26263

2. Raise lift link turn handle (C) from transport position and locking tab (D).
3. Rotate handle (C) to raise or lower draft link until 3-point hitch mounted implement is level from side-to-side.
4. Return handle to the transport position with handle notch on locking tab (D).

Adjusting Implement Side-to-Side Sway

NOTE: Check implement operator's manual procedure for adjusting sway links. When sway links have been properly adjusted, side sway of implement is controlled by position of links.

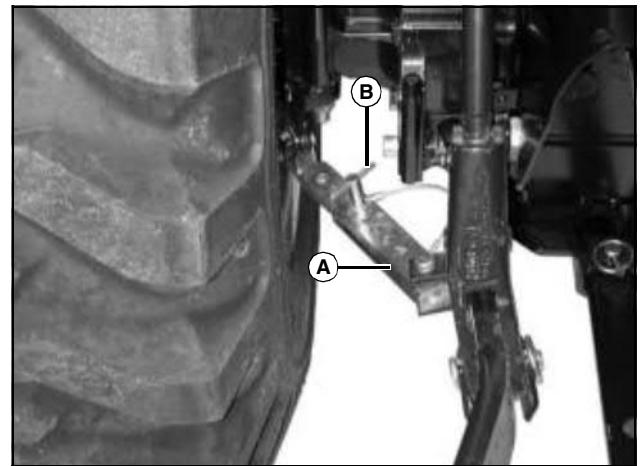

MX20929

Use left and right sway links (A) to adjust 3-point hitch implement side-to-side sway:

1. Park machine safely. (See Parking Safely in the SAFETY section.)
2. Remove locking pin (B).
3. Slide links to adjust length.
4. Install locking pin (B).

Adjusting Draft Links to Float Position

Adjusting 3-point hitch stops to the float position will allow both draft links to raise slightly as the implement follows

OPERATING - MACHINE

ground contour.

Adjust stops to the float position for 3-point hitch implements such as a cultivator or mower. These implements will have ground gauging skids or wheels which may otherwise cause the implement to twist relative to the machine.

1. Park machine safely. (See Parking Safely in the SAFETY section.)

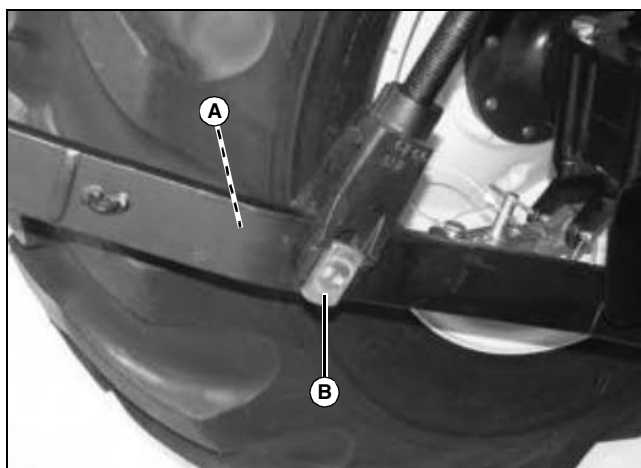

MX25811

Picture Note: Float Position

2. Remove spring locking pin (A) and rotate stop pin (B) 90 degrees to position shown..

Adjusting Draft Links to Rigid Position

Adjusting 3-point hitch stops to the rigid position will restrict movement of the draft links as the implement follows ground contour.

Adjust stops to the rigid position for 3-point hitch implements such as plows and ground engaging implements that should not twist relative to the machine.

1. Park machine safely. (See Parking Safely in the SAFETY section.)

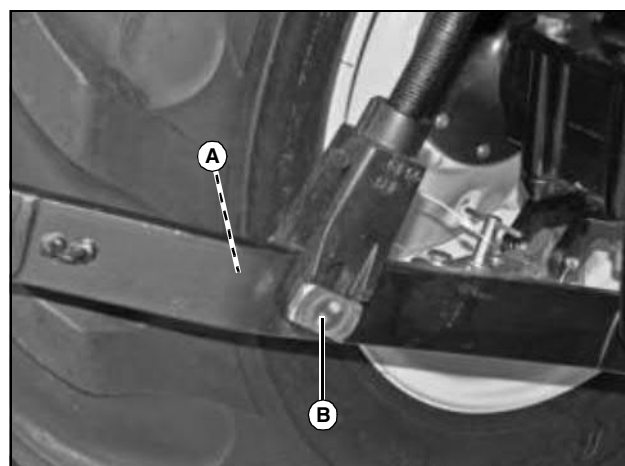

MX25810

Picture Note: Rigid Position

2. Remove spring locking pin (A) and rotate stop pin (B) 90 degrees to position shown.

Using iMatch™ Quick-Hitch

Installing Hitch

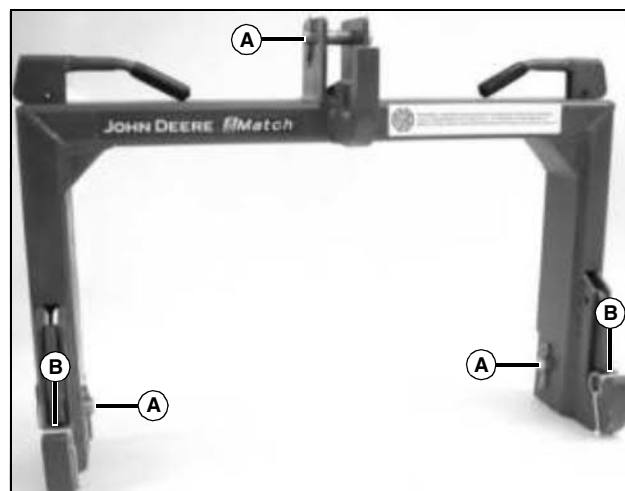

MX10720

1. Remove three drilled pins (A) and two bushings (B) from hitch.
2. Use machine rockshaft control lever to fully lower 3-point hitch draft links.
3. Park machine safely. (See Parking Safely in the SAFETY section.)
4. Position hitch near draft links and adjust 3-point hitch sway links to align draft links with hitch.
5. Install hitch on draft links using drilled pins.
6. Install 3-point hitch center link on hitch using center link quick-lock pin and drilled pin.

OPERATING - MACHINE

Connecting Implement

1. Install two bushings included with hitch on drilled pins in implement draft link lift brackets.

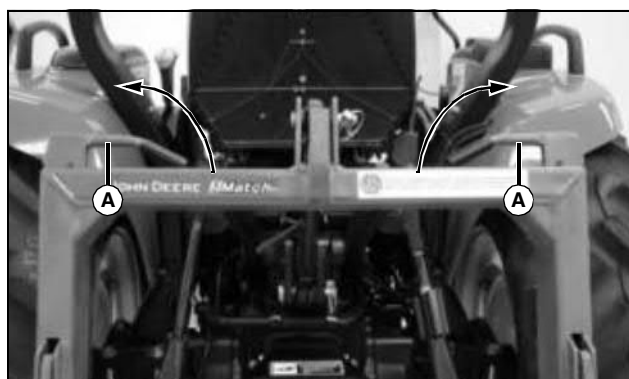

MX10706

2. Move levers (A) on hitch to unlocked position.
3. Back machine into position and align hitch with implement lift brackets.
4. Use rockshaft control lever to position hitch under lift brackets and lift implement from ground.

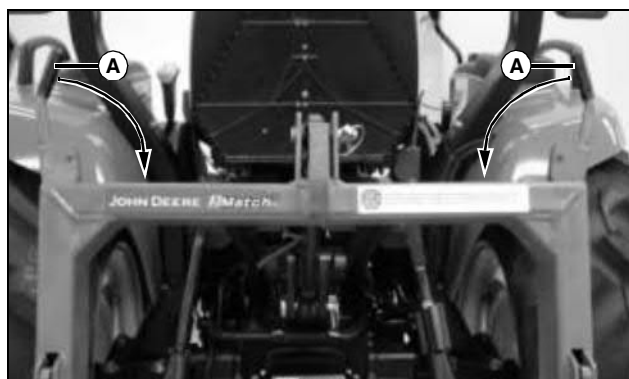

MX10713

5. Fully raise implement. Move levers (A) on hitch to locked position.

Removing Implement and Hitch

1. With implement in raised position, move levers to unlocked position, then lower implement to ground.
2. Move tractor forward to disengage hitch from implement.
3. Move levers on hitch to locked position.
4. Use machine rockshaft control lever to fully lower hitch and 3-point draft links.
5. Remove drilled pins from 3-point hitch center link and draft links.
6. Place drilled pins in hitch for storage.
7. Move tractor forward to disengage from hitch.

Connecting Implement Hydraulic Hoses



CAUTION: Avoid injury! Escaping fluid under high pressure can penetrate the skin and cause serious injury. Avoid the hazard by relieving pressure before connecting hydraulic or other lines. Tighten all connections before applying pressure.

- Search for leaks with a piece of cardboard. Protect hands and body from high pressure fluids.
- If an accident occurs, see a doctor immediately. Any fluid injected into the skin must be surgically removed within a few hours or gangrene may result. Doctors unfamiliar with this type of injury should reference a knowledgeable medical source. Such information is available from Deere & Company Medical Department in Moline, Illinois, U.S.A. In the United States and Canada only, this information may be obtained by calling 1-800-822-8262.

1. Park machine safely. (See Parking Safely in the SAFETY section.)
2. Relieve hydraulic pressure:
 - Move dual selective control valve (SCV) lever rearward-to-forward and side-to-side several times.
 - Move third SCV lever rearward-to-forward several times if equipped.
3. See your implement operator's manual for specific instructions on connecting hydraulic hoses to couplers. Install hose ends in couplers with matching colors.
 - Colors for the couplers are shown on the label installed on the machine near the couplers.
4. See your implement operator's manual for specific instructions on operating SCV controls.

IMPORTANT: Avoid damage! To prevent contamination of female quick couplers, color-coded hose ends should be installed in the couplers when not being used.

OPERATING - MACHINE

Using Dual Selective Control Valve Lever

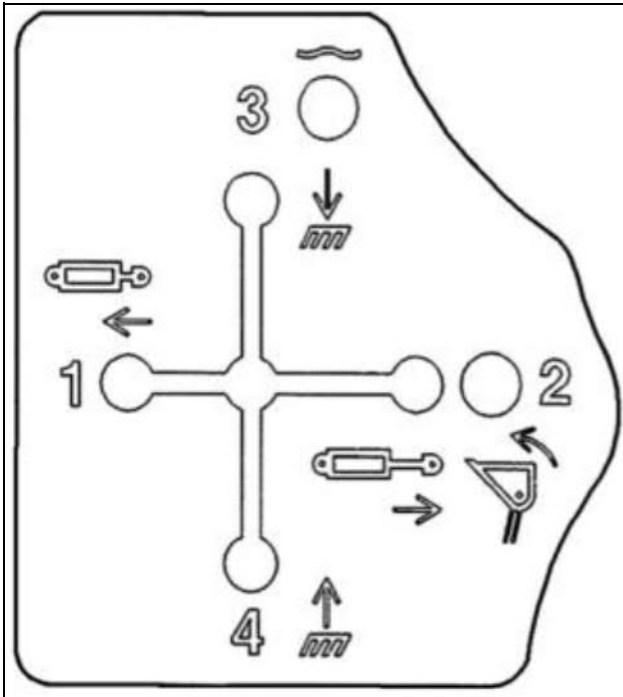

LVU13242

Picture Note: Standard label which may not exactly match label on your machine.

The label installed on the machine next to the dual selective control valve (SCV) lever shows the different lever positions.

Lever positions numbered 1-4 on the label match hydraulic line couplers numbered 1-4 on the machine near the couplers. Moving the lever to position 1 will supply fluid to coupler 1 and return fluid through coupler 2 and so forth.

Lever Position	Fluid Supply	Fluid Return
Left to position 1	1	2
Right to position 2	2	1
Foward to position 3	3	4
Rearward to position 4	4	3

Move the lever to the full right or “regen” position for faster loader bucket dumping.

Move the lever to the full forward or “float” position to remove pressure in both lines 3 and 4 and allow fluid to flow back and forth between the lines. The lever may be left in the “float” position.

Using Dual Selective Control Valve (SCV) Lock Lever

Tractor without Cab

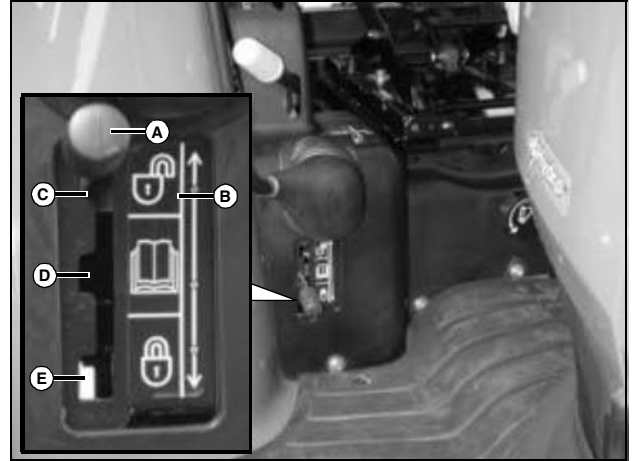

MX20931, MX10719

Selective Control Valve (SCV) lock lever (A) allows the operator to control the type of dual SCV lever movement needed for a particular operation or situation. Operation of the lock lever is indicated on label (B).

- To allow movement of dual SCV lever in all directions, move lock lever to the top position (C). Operation of the dual SCV is totally unlocked.
- To prohibit engagement of the regen (regeneration) function of the dual SCV, move lock lever to the middle position (D). This position is recommended for all implements except for the front loader. Heavily-loaded loader buckets will dump more rapidly when the regen function is engaged. The regen function is available only with the lock lever in position C.
- To prohibit movement of dual SCV lever in all directions, move lock lever to the bottom position (E). Operation of the dual SCV is totally locked.

OPERATING - MACHINE

Tractor with Cab

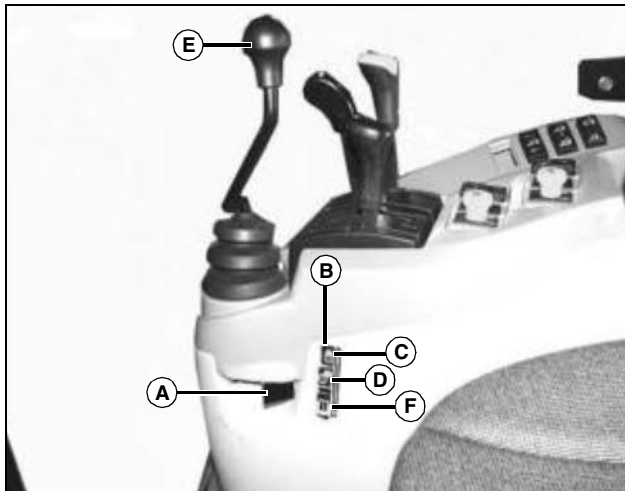

MX22938

Selective Control Valve (SCV) lock lever (A) allows the operator to control the type of dual SCV lever movement needed for a particular operation or situation. Operation of the lock lever is indicated on label (B).

- To allow movement of dual SCV lever in all directions, push the lock lever inward to center position (D). Operation of the dual SCV is totally unlocked.
- To prohibit engagement of the regen (regeneration) function of the dual SCV, push the lock lever all the way inward (F). This position is recommended for all implements except for the front loader. Heavily-loaded loader buckets will dump more rapidly when the regen function is engaged.
- To prohibit movement of dual SCV lever in all directions, make sure SCV lever (E) is in center position, and pull the lock lever straight outward (C). Operation of the dual SCV is totally locked.

NOTE: After extended use, the dual SCV lever may require cable adjustment to lock out.

Using Hydraulic Third Selective Control Valve (SCV)



CAUTION: Avoid injury! Escaping fluid under high pressure can penetrate the skin and cause serious injury. Avoid the hazard by relieving pressure before connecting hydraulic or other lines. Tighten all connections before applying pressure.

- Search for leaks with a piece of cardboard. Protect hands and body from high pressure fluids.
- If an accident occurs, see a doctor immediately. Any fluid injected into the skin must be surgically removed within a few hours or gangrene may result. Doctors unfamiliar with this type of injury should reference a knowledgeable medical source. Such information is available from Deere & Company Medical Department in Moline, Illinois, U.S.A. In the United States and Canada only, this information may be obtained by calling 1-800-822-8262.

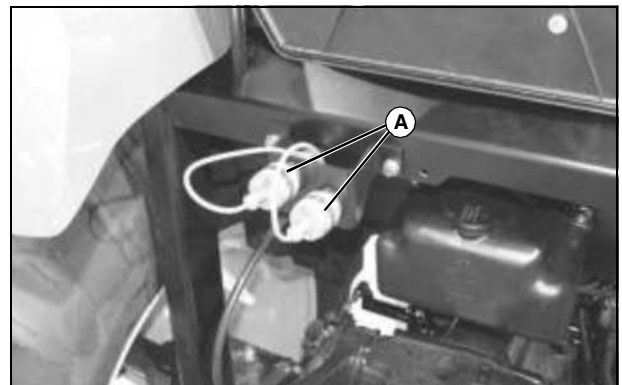

MX35751

Picture Note: Tractor with cab shown.

This machine model series can be equipped with an optional hydraulic third Selective Control Valve (SCV) and hydraulic outlets to operate hydraulically-driven implements.

The machine-mounted hydraulic outlets are female quick couplers (A).

When the implement hydraulic hoses are connected to the couplers, move the third SCV lever forward to divert fluid to the lower connector line and return through the upper connector line. Move the lever rearward to divert fluid to the upper connector line and return through the lower connector line. Move the lever to the full forward or "float position" to remove pressure in both connector lines and allow fluid to flow back and forth between the lines.

OPERATING - MACHINE

See your implement Operator's Manual for implement functions which correspond to lever positions.

IMPORTANT: Avoid damage! To prevent contamination of female quick couplers, color-coded hose ends should be installed in the couplers when not being used.

Using Diverter Valve

CAUTION: Avoid injury! Escaping fluid under high pressure can penetrate the skin and cause serious injury. Avoid the hazard by relieving pressure before connecting hydraulic or other lines. Tighten all connections before applying pressure.

- Search for leaks with a piece of cardboard. Protect hands and body from high pressure fluids.
- If an accident occurs, see a doctor immediately. Any fluid injected into the skin must be surgically removed within a few hours or gangrene may result. Doctors unfamiliar with this type of injury should reference a knowledgeable medical source. Such information is available from Deere & Company Medical Department in Moline, Illinois, U.S.A. In the United States and Canada only, this information may be obtained by calling 1-800-822-8262.

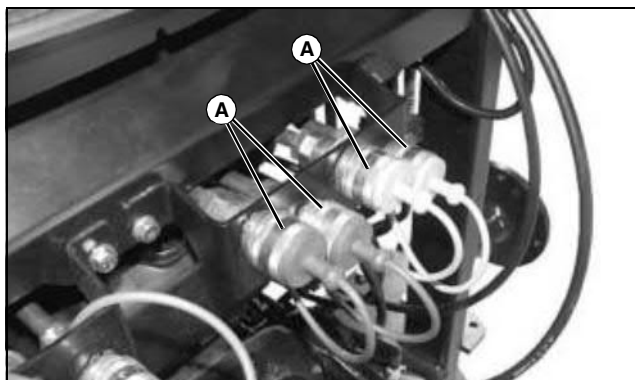

Picture Note: Tractor with cab shown.

This machine model series can be equipped with an optional diverter valve and hydraulic outlets to operate hydraulically-driven implements.

The machine-mounted hydraulic outlets are female quick couplers (A).

NOTE: If the key switch is moved to the off position, the dual SCV lever will default to operating the front quick couplers. The key switch must be moved to the run position and the diverter system re-activated to operate the rear couplers.

1. Press the front of the diverter switch to activate the rear SCV quick coupler ports. The switch indicator light will go on.
2. Press the back of the diverter switch to deactivate the rear SCV quick coupler ports. The switch indicator light will go off.

Using Accessory Electrical Outlet

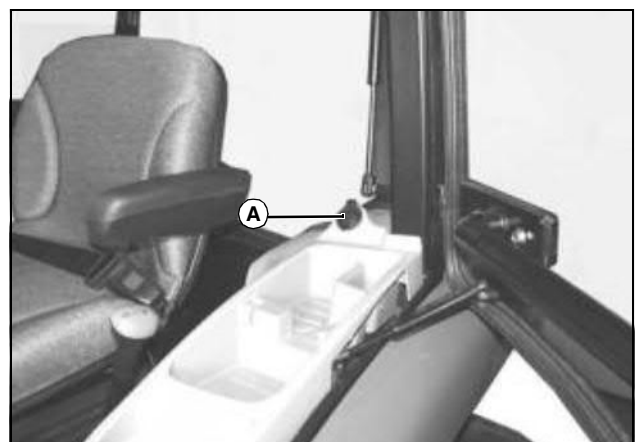

Accessory 12-volt electrical outlet (A) is used when connecting auxiliary equipment.

Ballasting Machine

CAUTION: Avoid injury! Ballasted machine may become unstable when attachment is raised. Always drive slowly over uneven ground and when turning with raised attachment.

IMPORTANT: Avoid damage! Do not overload tires. Do not exceed tire maximum inflation pressure or maximum load capacity.

Add weight to machine front end if needed for stability. Heavy pulling and heavy rear mounted implements tend to lift front wheels. Add enough ballast to maintain steering control and prevent tip over. Remove weight when it is no longer needed.

OPERATING - MACHINE

IMPORTANT: Avoid damage! Remove ballast from machine when no longer needed.

Implement Codes

Use the following tables to determine the number of front weights to use with John Deere implements that show implement code data in the ballasting section of the implement operator's manual.

Match the implement code from the implement manual with the codes for your type of hitch.

These codes are for ideal conditions. Actual field conditions may require additional ballast. Some John Deere implements may recommend using a certain number of front weights rather than giving implement codes.

Tractor Without Cab Implement Codes

Implement Code Using 42 lb. (20 kg) Weights		
Number of Weights	Standard 3-Point Hitch with Code	iMatch Quick-Hitch with Code
0	36	34
1	38	35
2	39	37
3	41	38
4	42	39
5	44	41
6	47	44
7	48	45
8	50	47
9	52	48
10	53	50

Implement Code Using 70 lb. (32 kg) Weights		
Number of Weights	Standard 3-Point Hitch with Code	iMatch Quick-Hitch with Code
0	36	34
1	39	36
2	41	38
3	44	41
4	46	43
5	49	46

Implement Code Using 70 lb. (32 kg) Weights		
Number of Weights	Standard 3-Point Hitch with Code	iMatch Quick-Hitch with Code
6	53	50
7	56	52
8	59	55
9	61	57
10	64	60

Tractor With Cab Implement Codes

Implement Code Using 42 lb. (20 kg) Weights		
Number of Weights	Standard 3-Point Hitch with Code	iMatch Quick-Hitch with Code
0	42	39
1	43	40
2	45	42
3	46	43
4	48	45
5	49	46
6	52	49
7	54	50
8	55	52
9	57	53
10	59	55

Implement Code Using 70 lb. (32 kg) Weights		
Number of Weights	Standard 3-Point Hitch with Code	iMatch Quick-Hitch with Code
0	42	39
1	44	41
2	47	44
3	49	46
4	52	48
5	55	51
6	59	55
7	62	57

OPERATING - MACHINE

Implement Code Using 70 lb. (32 kg) Weights		
Number of Weights	Standard 3-Point Hitch with Code	iMatch Quick-Hitch with Code
8	64	60
9	67	62
10	70	65

Tire Capacities

IMPORTANT: Avoid damage! Do not overload tires. Do not exceed tire maximum inflation pressure or maximum load capacity.

If required ballast will exceed tire load capacity, reduce load or install other tires.

Recommended operating pressures for Golf tires are 6 psi rear and 8 psi front. Operate at reduced loads. If MFWD is engaged with tires at maximum air pressure, front axle damage may result.

See tire maximum inflation pressure and maximum load capacities in the SPECIFICATIONS section.

Verify maximum tire inflation pressure and maximum load information if embossed into the tire side wall.

Using Rear Cast Iron Wheel Weights

IMPORTANT: Avoid damage! Do not overload tires. Do not exceed tire maximum inflation pressure or maximum load capacity.

1. Mount rear wheels in the wide position for improved stability.

CAUTION: Avoid injury! Machine component or attachment is heavy. Use a safe lifting device or get an assistant to help lift, install or remove component or attachment.

2. Fasten weight to each rear wheel using a safe lifting device. A total of three weights per wheel may be used. See your implement operator's manual for installation and number of weights to use.

Rear wheel weights are available from your John Deere Dealer.

Using Rear Ballast Box

CAUTION: Avoid injury! To improve front loader-machine stability, use of ballast box is recommended. Use ballast as recommended in loader operator's manual.

IMPORTANT: Avoid damage! Do not overload tires. Do not exceed tire maximum inflation pressure or maximum load capacity.

The rear ballast box is used for carrying ballast on the 3-point hitch. Approximate weight of different materials is given in the implement operator's manual.

Using Liquid Weight in Tires

CAUTION: Avoid injury! Installing liquid ballast requires special equipment and training. Injury may occur from exploding tire. Have the job done by your John Deere dealer or a tire service store.

IMPORTANT: Avoid damage! Cover rim completely with solution to avoid corrosion, but never more than 90 percent full. More solution would leave too little air space to absorb shocks. Damage to tire could occur.

NOTE: Use of alcohol as ballast is not recommended. Calcium chloride solution is heavier and more economical.

A solution of water and calcium chloride provides safe economical ballast, and will prevent freezing. If used properly, it will not damage tires, tubes, or rims.

A mixture of 0.4 kg of calcium chloride per liter of water (3.5 lb/gal), will not freeze solid above -45° C (-50° F).

Fill tubeless tires at least to valve stem level (minimum 75% full). Less solution would expose part of rim, possibly causing corrosion.

Tube-type tires may be filled to any level below 90%.

OPERATING - MACHINE

Using Front Weights

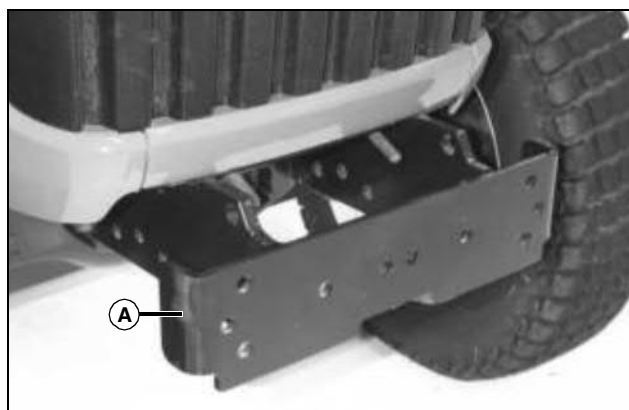

MX20594

Front weight bracket (A) is an integral part of the machine frame. The bracket will hold up to five Quick-Tatch® weights.

Quick-Tatch weights and attaching hardware are available at your John Deere dealer.

See your implement operator's manual for installation and required number of weights to use.

Front Weight Bracket Extension

A front weight bracket extension kit to hold additional Quick-Tatch weights is available at your John Deere dealer.

Transporting Machine on Trailer



CAUTION: Avoid injury! Use extra care when loading or unloading the machine into a trailer or truck.

Close fuel shut-off valve, if your machine is equipped.

IMPORTANT: Avoid damage! Transporting a machine on a trailer or on a truck bed at high speeds can result in hood or engine cover raising and possibly coming off machine if not secured.

- Position machine on trailer so hood or engine cover opens from rear of trailer to prevent wind from blowing hood or cover open.
- Secure hood or engine cover with existing machine locks or latches.
- Secure hood or engine cover with tie down straps if no locks or latches exist.

NOTE: Use a heavy-duty trailer to transport your machine.

1. Drive machine forward onto trailer.
2. Lower any implements to trailer deck.
3. Lock the park brake.
4. Stop the engine.
5. Remove the key.
6. Close the fuel shut-off valve.
7. Fasten machine to trailer with heavy-duty straps, chains, or cables. Both front and rear straps must be directed down and outward from machine. Trailer must have signs and lights as required by law.
8. Plug exhaust pipe to avoid unintended turbo spinning and damage.

Transporting Machine

Driving Machine Safely on Roads

Observe the following precautions when operating the machine on a road:



CAUTION: Avoid injury! Use caution when operating machine at transport speeds. Reduce speeds if towed load weighs more than machine. Consult towed equipment operator's manual for recommended transport speeds.

Use additional caution when transporting towed loads under adverse surface conditions, especially when turning, and on inclined surfaces.

Use of warning lights and turn signals are recommended when traveling on public roads unless prohibited by state or local regulations. An implement safety lighting kit is available from your John Deere dealer.

- Make sure brake pedals are locked together with the brake pedal latch.
- Make sure SMV (Slow Moving Vehicle) emblem and warning lights are clean and visible. If towed or rear-mounted equipment obstructs these safety devices, install SMV emblem and warning lights on equipment.
- Rotate light switch to road position.
- Drive slowly enough to maintain safe control at all times. Slow down for hillsides, rough ground, and sharp turns, especially when transporting heavy, rear-mounted implements.
- Adjust tread width position of rear wheels to provide maximum stability.
- If equipped, disengage the MFWD to reduce tire wear.

OPERATING - MACHINE

- Never coast machine downhill.

Pushing or Towing Machine



CAUTION: Avoid injury! Never tow machine faster than 16 km/h (10 mph). If possible, have someone operate steering and brakes of towed tractor.

IMPORTANT: Avoid damage! Push or tow machine for short distances only.

1. Push all PTO engagement knobs to the disengaged/off position.
2. Disengage the differential lock.
3. Unlock the park brake.
4. Move transmission to neutral position:
 - PowrReverser: Depress clutch pedal completely and move the transmission gear and range shift levers and the reverser lever to the N (neutral) position.
 - eHydro model: Move the range shift lever to the N (neutral) position.
5. If equipped, disengage the MFWD.
6. Make sure brake pedals are locked together with the brake pedal latch to slow or stop machine.

Towing Loads



CAUTION: Avoid injury! Stopping distance increases with speed and weight of towed load, and on slopes. Towed loads with or without brakes that are too heavy for the machine or are towed too fast can cause loss of control. Consider the weight of the equipment and its load.

Observe these recommended maximum road speeds, or local speed limits which may be lower:

- **If towed equipment does not have brakes, do not travel more than 32 km/h (20 mph) and do not tow loads more than 1.5 times the tractor weight.**

- **If towed equipment has brakes, do not travel more than 40 km/h (25 mph) and do not tow loads more than 4.5 times the machine weight.**

Ensure the load does not exceed the recommended weight ratio. Add ballast to recommended maximum for machine, lighten the load, or get a heavier towing unit. The machine must be heavy and powerful enough with adequate braking power for the towed load. Use additional caution when towing loads under adverse surface conditions, when turning, and on inclines.

1. Hitch the towed load only to the drawbar. Lock the drawbar and pin in place.
2. Install a safety chain to the machine drawbar support and to the towed load. Provide only enough slack to permit turning.
3. Before descending a hill, shift to a gear low enough to control machine travel speed without having to use the brake pedals to brake the machine and installed implements.

OPERATING - MACHINE

Using Safety Chain

CAUTION: Avoid injury! Hitch towed loads only to the drawbar to avoid rearward upset. Do not use the safety chain for towing loads.

IMPORTANT: Avoid damage! Secure the towed load to the drawbar. The safety chain is designed to help control the towed load should it separate from the drawbar.

Use a chain with a strength rating greater than the gross weight of the towed load.

Replace or repair the safety chain if one or more links or fittings are broken, stretched or damaged.



MX26260

1. Use the appropriate adapter parts (A) to attach the safety chain to the machine drawbar support and to the towed load. Provide only enough slack to permit turning.
2. Install additional attaching points (B) for the chain on drawbar to reduce slack in chain when necessary.
3. Remove the safety chain and store when not in use.

Raising and Lowering Roll-Over Protective Structure (ROPS)

Lowering ROPS Crossbar

CAUTION: Avoid injury! Always wear seat belt when operating machine with folding Roll-Over Protective Structure (ROPS) in upright position. Do not jump from machine if machine tips.

If ROPS must be folded to operate in a low clearance area, do not use seat belt. Raise ROPS and use seat belt as soon as conditions permit.

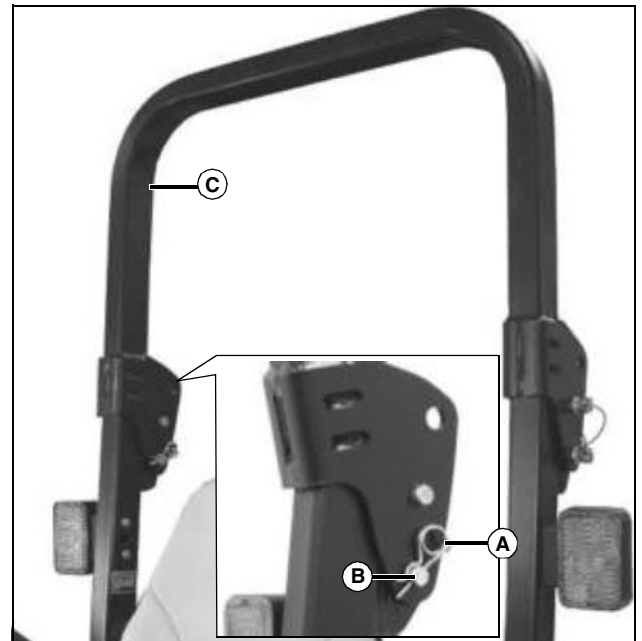

MX20944, MX10724

1. Remove spring locking pin (A) and drilled pin (B) on each side of the ROPS.
2. Carefully lower ROPS crossbar (C).

OPERATING - MACHINE

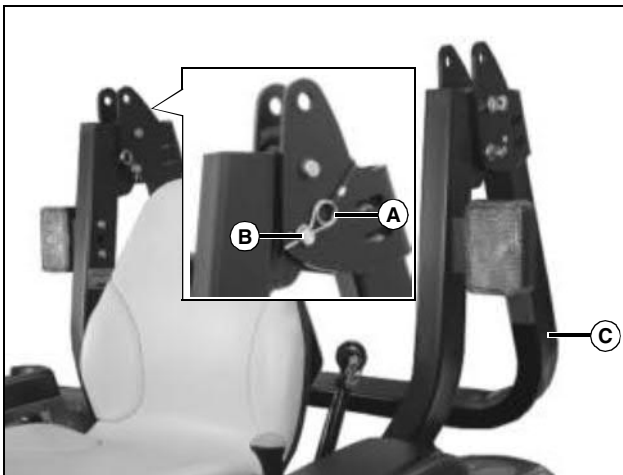

MX20945, MX10726

3. Align crossbar bracket holes with support bracket holes on each side of the ROPS.

4. Install drilled pins (B) and spring locking pins (A) to lock crossbar (C) in the lowered position.

Raising ROPS Crossbar

1. Remove spring locking pins (A) and drilled pins (B) on each side of the ROPS.

2. Carefully raise ROPS crossbar (C) to the operating position.

3. Align crossbar bracket holes with support bracket holes on each side of the ROPS.

4. Install drilled pins (B) and spring locking pins (A) to lock crossbar (C) in the raised position.

REPLACEMENT PARTS

Service Literature

If you would like a copy of the Parts Catalog or Technical Manual for this machine call:

- **U.S. & Canada:** 1-800-522-7448.
- **All Other Regions:** Your John Deere dealer.

Parts

We recommend John Deere quality parts and lubricants, available at your John Deere dealer.

Part numbers may change, use part numbers listed below when you order. If a number changes, your dealer will have the latest number.

When you order parts, your John Deere dealer needs the serial number or product identification number (PIN) for your machine or attachment. These are the numbers that you recorded in the Product Identification section of this manual.

Order Service Parts Online

Visit <http://JDParts.deere.com> for your Internet connection to parts ordering and information.

Part Numbers

Item	Part Number
Air Cleaner Assembly:	
• Primary Element	• RE68048
• Secondary Element	• RE68049
Engine Oil Filter	M806419
Fuel Filter Element	M811031
Alternator Belt - 40 Amp Alternator	LVU11661
Alternator Belt - 55 or 75 Amp Alternator	LVU11662
Hydraulic Suction Oil Filter	LVA13065
Battery	TY25877
Light Bulbs (Tractor):	
• Head Lamp	• 57M7166
• Tail Lamp	• AR48041
• Flashers	• AD2062R
• Work Lamp (Option)	• R136239

Item	Part Number
Light Bulbs (Cab):	
• Tail Lamp	• M148478
• Work Lamp	• AH166909
• Turn/Warning Lamp	• RE49778
• Beacon Lamp	• 57M7019
• Dome Lamp	• RE200798
• Head Lamp	• 57M7166
Fuses:	
• 10 Amp	• 57M7689
• 15 Amp	• 57M7690
• 20 Amp	• 57M7691
• 30 Amp	• 57M8163

(Part numbers are subject to change without notice. Part Numbers may be different outside the U.S.A.)

SERVICE INTERVALS

Servicing Your Machine

IMPORTANT: Avoid damage! Operating in extreme conditions may require more frequent service intervals:

- **Engine components may become dirty or plugged when operating in extreme heat, dust or other severe conditions.**
- **Engine oil can degrade if machine is operated constantly at slow or low engine speeds or for frequent short periods of time.**

Please use the following timetables to perform routine maintenance on your machine.

As Needed

- Replace alternator belt.
- Replace air filter elements (see air restriction indicator).
- Replace cab air filters.
- Replace light bulbs.
- Replace fuses.
- Clean and replace battery.
- Replace radiator hoses and clamps.
- Check tire air pressure.
- Clean fuel tank overflow reservoir.
- Drain water and sediment from fuel tank, and service water separator.
- Check and adjust front wheel toe-in.
- Check and clean grille and side screens.
- Check and clean radiator cooling screen.
- Clean debris from engine compartment.
- Adjust all cables to acquire appropriate travel for engagement (cabs).

After First 10 Hours

- Check wheel bolt torque.
- Check cab rollover protection system mounting hardware torque.
- Check windshield wiper arm mounting hardware torque.

Every 10 Hours or Daily

- Test safety systems.
- Check engine oil level.
- Check transmission oil level.
- Check air filter rubber dust unloading valve.
- Check radiator coolant level.

Every 50 Hours

- Check front axle oil level.
- Lubricate machine.
- Check cab protection system mounting hardware torque.
- Clean or replace cab air filters.

Every 200 Hours

- Change engine oil and filter.
- Inspect alternator belt.
- Check air restriction indicator light.
- Check wheel bolt torque.

Every 400 Hours

- Change transmission oil and filter.
- Replace fuel filter.

Every 600 Hours

- Check engine low idle speed.
- Check air filter intake hoses and clamps.
- Change front axle oil.
- Check front axle thrust bolt torque.
- Check brake adjustment.

Yearly

- Change engine oil and filter if less than 200 hours of operation.
- Drain water from fuel tank and replace fuel filter.
- Check all hoses and clamps.
- Check battery electrolyte level.

SERVICE INTERVALS

Every 1200 Hours

- Check and clean inline hydraulic filter.
- Check engine valve clearance. See your John Deere dealer.

Every Two Years or 2000 Hours

- Flush and replace factory coolant. Flush cooling system and replace coolant with John Deere COOL-GARD engine coolant.
- Service fuel injection nozzles.

SERVICE LUBRICATION

Grease

IMPORTANT: Avoid damage! Use recommended John Deere greases to avoid component failure and premature wear.

The recommended John Deere greases are effective within an average air temperature range of -29 to 135 degrees C (-20 to 275 degrees F).

If operating outside that temperature range, contact your Servicing dealer for a special-use grease.

The following greases are preferred:

- John Deere Multi-Purpose SD Polyurea Grease
 - John Deere Multi-Purpose HD Lithium Complex Grease
- If not using any of the preferred greases, be sure to use a general all-purpose grease with an NLGI grade No.2 rating.

Wet or high speed conditions may require use of a special-use grease. Contact your Servicing dealer for information.

The following lubricant is preferred:

- SUPER LUBE® lubricant.¹

Lubricating Machine Grease Fittings

- **Extremely Wet and Muddy Conditions** - Lubricate machine grease fittings every 10 hours of operation or on a daily basis
- **All Other Conditions** - Lubricate machine grease fittings every 50 hours of operation

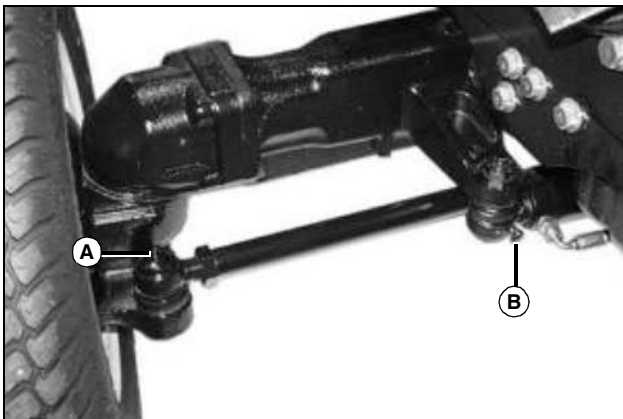

MX32647

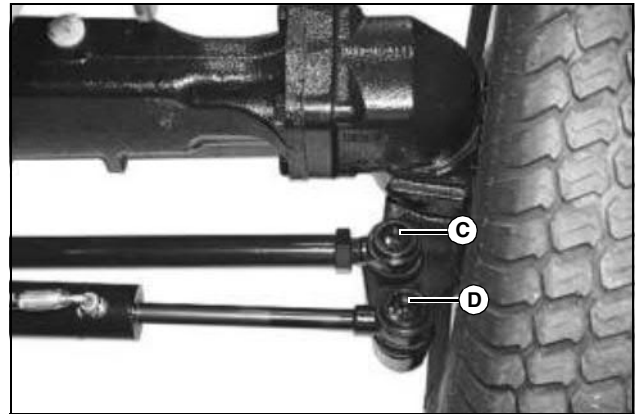

MX32648

- A - Left Tie Rod End
- B - Left Steering Cylinder Ball Joint
- C - Right Tie Rod End
- D - Right Steering Cylinder Ball Joint

Lubricating 3 Point Hitch

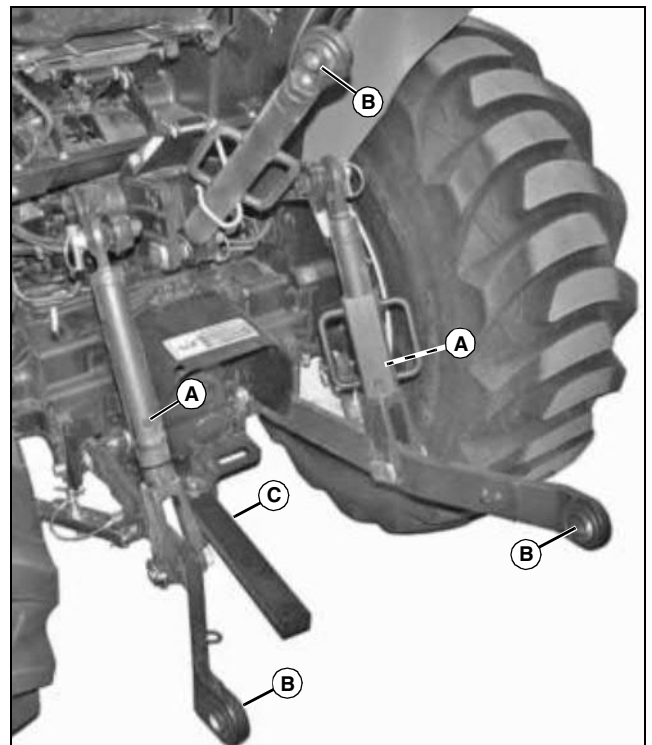

MX23851

- Lubricate lift link grease fittings (A) with recommended grease or an equivalent.
- Lubricate ball joints (B) and draw bar (C) with SUPER LUBE lubricant.

¹. SUPER LUBE is a registered trademark of Synco Chemical Corp.

SERVICE ENGINE

Engine Warranty Maintenance Statement

Maintenance, repair, or replacement of the emission control devices and systems on this engine, which are being done at the customer's expense, may be performed by any non-road engine repair establishment or individual. Warranty repairs must be performed by an authorized John Deere dealer.

Avoid Fumes



CAUTION: Avoid injury! Engine exhaust fumes contain carbon monoxide and can cause serious illness or death.

Move the machine to an outside area before running the engine.

Do not run an engine in an enclosed area without adequate ventilation.

- **Connect a pipe extension to the engine exhaust pipe to direct the exhaust fumes out of the area.**
- **Allow fresh outside air into the work area to clear the exhaust fumes out.**

Engine Oil

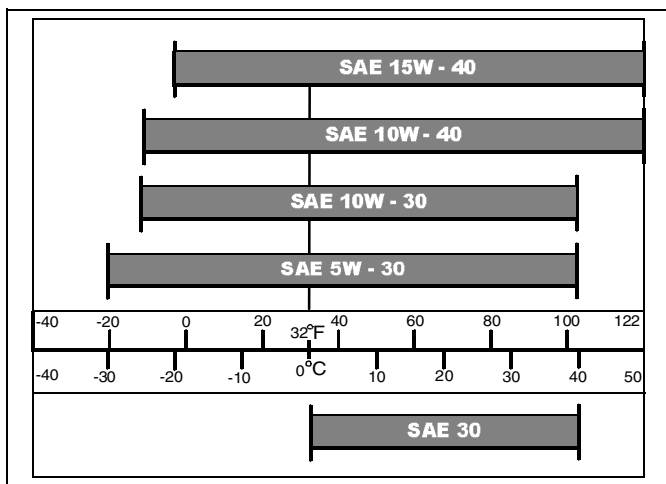

Choose oil viscosity based on the expected air temperature range during the period between oil changes.

John Deere PLUS-50™ oil is recommended. John Deere TORQ-GARD SUPREME™ and oils meeting ACEA Specification E4/E5 may also be used.

Other oils may be used if they meet one or more of the

following: API Service Classification CI-4, API Service Classification CH-4, or ACEA Specification E3.

Multi-viscosity diesel engine oils are preferred. Do not use break-in oils.

Checking Engine Speeds

Check engine speeds when engine is warmed up and not under load.

1. See low and high idle speeds in the SPECIFICATIONS section.
2. Observe tachometer.
3. If engine speeds are not within ± 25 rpm of specifications, see your John Deere dealer.

Checking Engine Oil Level

IMPORTANT: Avoid damage! Failure to check the oil level regularly could lead to serious engine problems if oil level is low:

- **Check oil level before operating.**
- **Check oil level when the engine is cold and not running.**
- **Keep level between the Full and the Add marks.**
- **Shut off engine before adding oil.**

NOTE: Check engine oil when engine is cold. If engine is warm, allow to cool for at least five minutes before checking oil.

1. Park the machine safely. (See Parking Safely in the SAFETY section.)

SERVICE ENGINE

IMPORTANT: Avoid damage! Dirt and contamination can enter engine when checking oil level. Clean area around dipstick before loosening or removing.

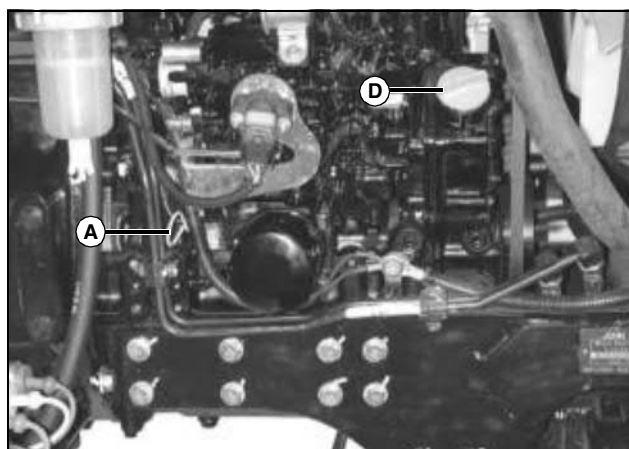

MX20949

2. Remove dipstick (A). Wipe with a clean cloth.
3. Install dipstick.

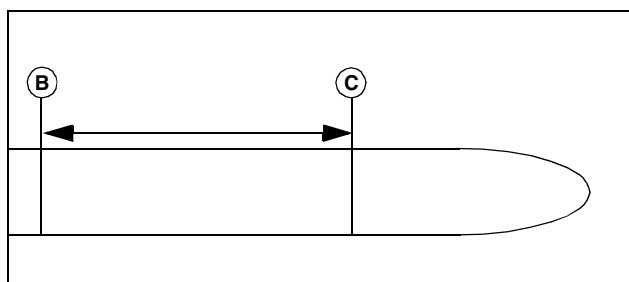

MIF

4. Remove dipstick.
5. Check oil level on dipstick. Oil level should be between levels (B) and (C) on dipstick.
6. If oil level is low:
 - a. Remove oil fill cap (D).
 - b. Add proper engine oil until oil level is within operating range on dipstick. Do not overfill.
7. Install oil fill cap (D).
8. If oil is above level (B) on the dipstick, drain to proper level.
9. Install dipstick.

Changing Engine Oil and Filter

1. Run engine to warm the oil.
2. Park machine safely. (See Parking Safely in the SAFETY section.)

3. Place drain pan under oil drain located on left side of engine.

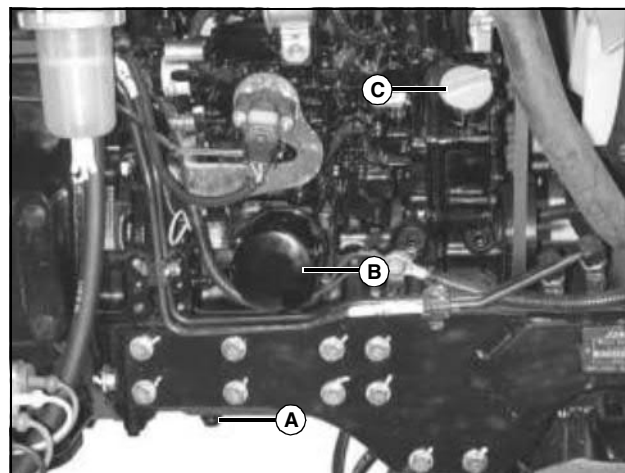

MX20949

4. Remove drain plug (A).
 - Remove two drain plugs on model 3720.
5. Wipe dirt from around oil filter (B).
6. Turn filter counter-clockwise to remove.
7. Put a light coat of clean engine oil on the gasket of new filter.
8. Install replacement oil filter by turning filter clockwise until gasket contacts filter base. Tighten additional one-half turn.
9. Install drain plug. Do not overtighten.
 - Install two drain plugs on model 3720.
10. Remove oil fill cap (C).
11. Add recommended engine oil.
12. Install oil fill cap.
13. Start and run engine at idle to check for leaks.
14. Stop engine. Fix any leaks before operating.
15. Check engine oil level and add oil if necessary.

Cleaning Dust Unloading Valve

IMPORTANT: Avoid damage! Do not operate engine without air cleaner element and rubber dust unloading valve installed.

1. Park the vehicle safely. (See Parking Safely in the SAFETY section.)
2. Allow engine to cool.
3. Access the engine compartment.

SERVICE ENGINE

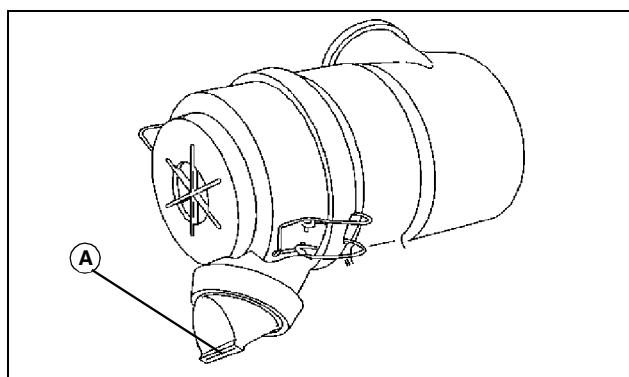

MX22502

4. Squeeze dust unloading valve (A) to clean. Remove and replace if damaged.

Servicing Air Filter Element

IMPORTANT: Avoid damage! Dirt and debris can enter the engine when removing the filter element. Service filter elements only when red signal is in view in the instrument panel. Shut off engine and turn off all lights before service.

Servicing Primary Element:

1. Park the machine safely. (See Park Safely in the SAFETY section.)
2. Allow engine to cool.
3. Check to be sure key switch and all lights are off. If the key switch or any lights are left on, the air restriction indicator light may continue to flash even after the filter has been replaced.
4. Raise hood.

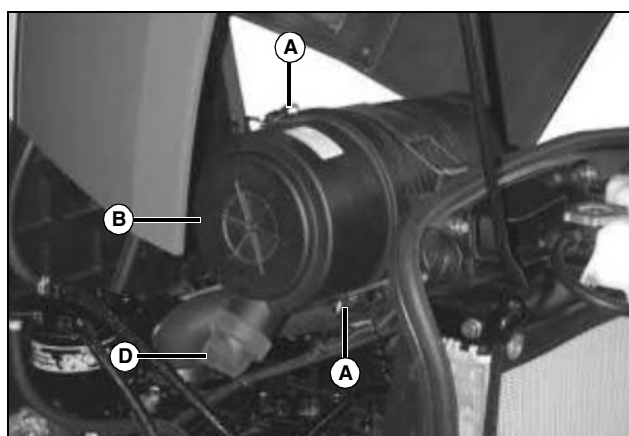

MX21767

5. Release latches (A) and remove air cleaner canister cover (B).

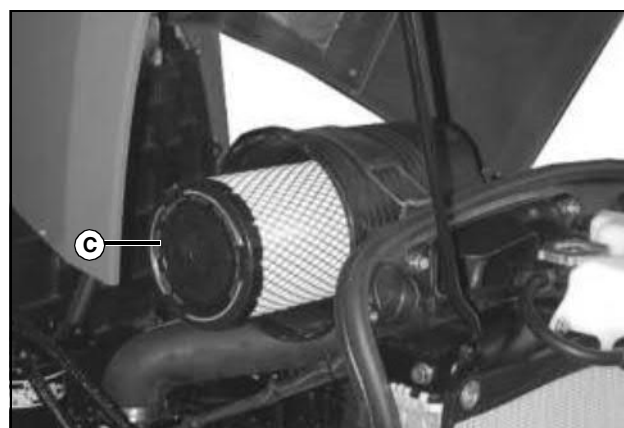

MX21768

6. Remove and discard primary element (C). Clean out any dirt in canister, taking care not to damage the secondary filter element. Replace with a new primary filter element.
7. Install air cleaner canister cover (B) with rubber dust unloading valve (D) pointing downward.
8. Check instruction molded into canister cover for proper installation.
9. Hook latches (A) onto cover.
10. Lower hood.

Servicing Secondary Element:

IMPORTANT: Avoid damage! Secondary element does not need routine replacement. Visually inspect it without removing from canister. Do not attempt to clean secondary element. If secondary element is replaced, install new primary and secondary element immediately to prevent dust from entering air intake system.

1. Remove air cleaner canister cover.
2. Remove and discard primary air filter element.

SERVICE ENGINE

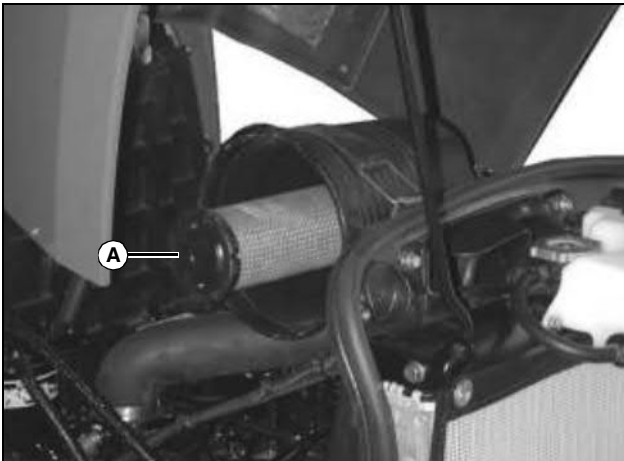

MX21769

NOTE: Upper air intake flange must be properly installed into shroud adapter (A) on radiator support frame.

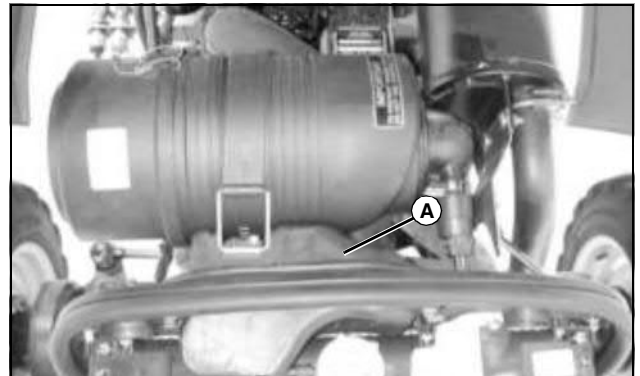

MX21817

3. Remove and discard secondary air filter element (A). Replace with a new secondary air filter element.
4. Install new primary air filter element.
5. Replace air cleaner canister cover.
6. Lower hood.

Checking Air Filter Hose

1. Park machine safely. (See Parking Safely in the SAFETY section.)
2. Raise hood.

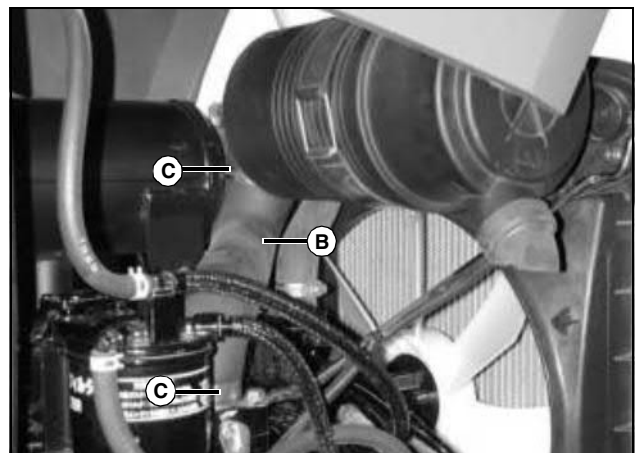

MX21766

Picture Note: Tractor without cab shown.

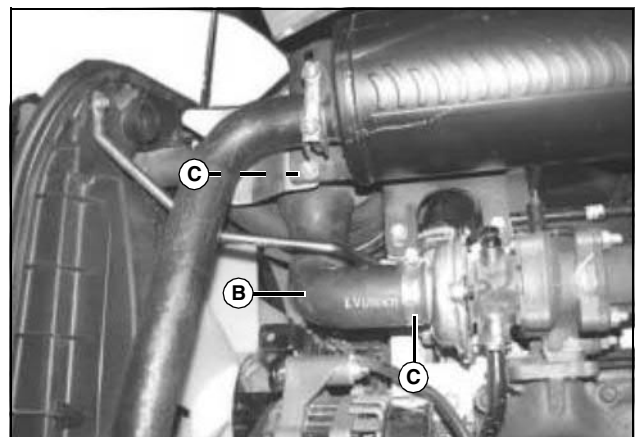

MX35768

Picture Note: Tractor with cab shown.

3. Locate lower air intake hose (B) below muffler, and tighten hose clamps (C).
4. Lower hood.

SERVICE ENGINE

Checking Air Restriction Indicator Light

- CAUTION:** Avoid injury! Servicing a machine while the engine is running is dangerous.
- Engine exhaust fumes contain carbon monoxide and can cause serious illness or death. Do not run an engine in an enclosed area without adequate ventilation.
 - Be cautious and wear protective clothing when servicing or working near a hot engine and components.
 - Keep hands, clothing, jewelry and long hair away from moving parts.

1. Park the machine safely. (See Park Safely in the SAFETY section.)
2. Start the engine.
3. Raise hood.



MX20948

4. Block the air intake hose (A) with cardboard or other solid material. Do not block with a cloth or any other material which would allow air to flow.
5. Increase throttle to full engine rpm.
6. The air restriction indicator light on the instrument panel should illuminate.
7. Turn off all light switches and stop the engine. The air restriction indicator light should go out.
8. Remove block to air intake hose and lower the hood.

Service Cooling System Safely

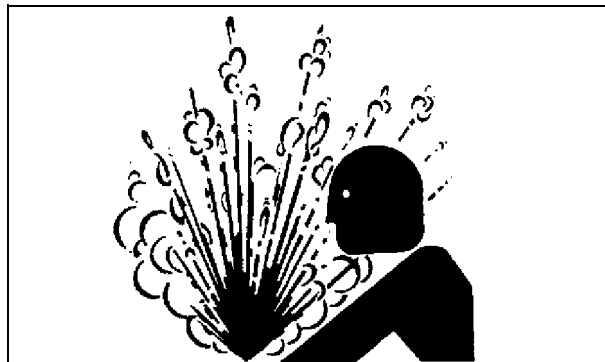

TS281

- CAUTION:** Avoid injury! The radiator will be hot and can burn skin. Built-up pressure may cause explosive release of coolant when the radiator cap is removed:
- Shut off the engine and allow to cool.
 - Do not remove the cap unless the radiator and the engine are cool enough to touch with bare hands.
 - Slowly loosen the cap to the first stop to release all pressure. Then remove the cap.

Checking Coolant Level

- IMPORTANT:** Avoid damage! Using incorrect coolant mixture can damage the radiator:
- Do not operate engine with plain water.
 - Do not exceed a 50% mixture of coolant and water.
 - Aluminum engine blocks and radiators require approved ethylene-glycol based antifreeze.

NOTE: If you suspect a leak, check the coolant level by removing the radiator cap and looking inside.

1. Park the vehicle safely. (See Park Safely in the SAFETY section.)
2. Allow engine to cool.
3. Raise hood.

SERVICE ENGINE

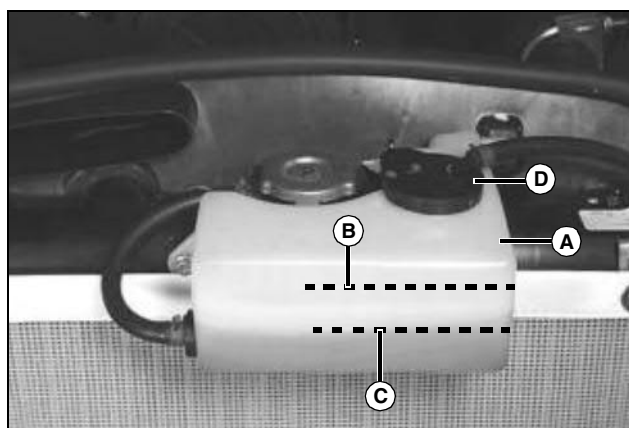

4. Check recovery tank (A) coolant level:

- If engine is warm, coolant level should be between the FULL HOT line (B) and the FULL COLD line (C).
- If engine is cold, coolant level should be at the FULL COLD line (C) on the recovery tank.

5. Remove recovery tank cap (D) if necessary to add coolant.

6. Add pre-diluted coolant or specified ratio of antifreeze and water.

7. Install recovery tank cap.

8. Lower hood.

Recommended Engine Coolant

IMPORTANT: Avoid damage! Using incorrect coolant mixture can cause overheating and damage to the radiator and engine:

- Do not operate engine with plain water.
- Do not exceed a 50% mixture of coolant and water.
- Aluminum engine blocks and radiators require approved ethylene-glycol based antifreeze.

The following John Deere coolants are preferred:

- COOL-GARD® PRE-DILUTED SUMMER COOLANT (TY16036).
- COOL-GARD® CONCENTRATED SUMMER COOLANT (TY16034).

If neither of the recommended coolants is available, use a glycol base coolant that meets the following specification:

- ASTM D4985 (JDM H24A2).

Check container label before using to be sure it has the

appropriate specifications for your machine. Use coolant with conditioner or add conditioner to coolant before using.

If using concentrate, mix approximately 50 percent antifreeze with 50 percent distilled or deionized water before adding to cooling system. This mixture will provide freeze protection to -37 degrees C (-34 degrees F).

Certain geographical areas may require lower temperature protection. See the label on your antifreeze container or consult your John Deere dealer to obtain the latest information and recommendations. Never exceed the maximum dilution rate for the coolant you are using. Exceeding the maximum rate will greatly reduce the coolant effectiveness.

Servicing Cooling System

Draining Cooling System

1. Park machine safely. (See Parking Safely in the SAFETY section.)
2. Allow engine to cool.
3. Raise hood.

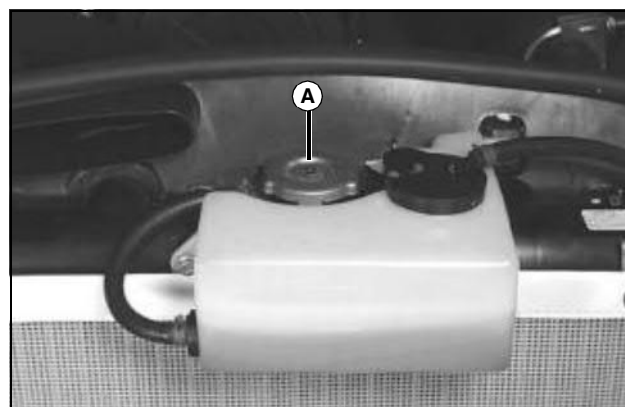

4. Slowly open radiator cap (A) to the first stop to release all pressure.

5. Close radiator cap tightly.

SERVICE ENGINE

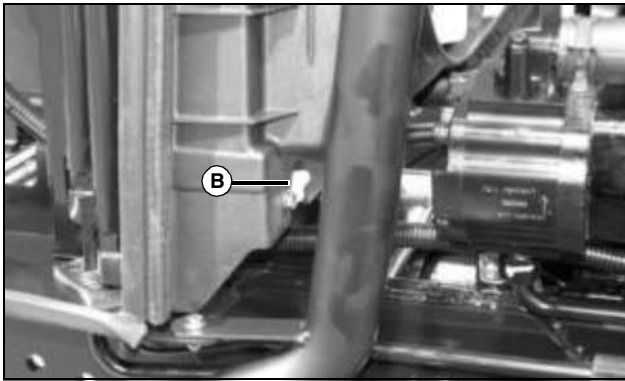

MX22968

6. Position drain pan under radiator petcock (B) on left side of machine. Open petcock and drain coolant.

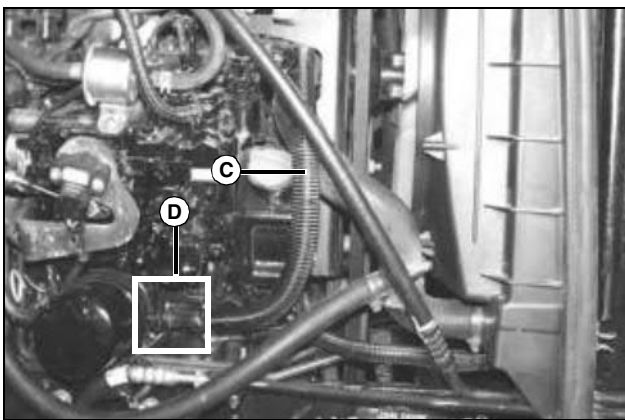

MX35769

Picture Note: Tractor with cab shown.

7. Disconnect coolant hose (C) at connection (D) to oil filter base, and allow all coolant to drain into pan.

8. After coolant drains from the recovery tank, remove radiator cap.

9. Close radiator petcock and connect coolant hose.

10. Flush cooling system.

Flushing Cooling System

1. Fill cooling system with clean water and John Deere Cooling System Cleaner, or John Deere Cooling System Quick Flush or an equivalent. Follow directions on container.

2. Install and tighten radiator cap.

3. Start and run engine until it reaches operating temperature.

4. Stop engine.

5. Open radiator petcock and disconnect coolant hose.

6. Drain cooling system immediately before rust and dirt settle.

7. Close radiator petcock and connect coolant hose.

Filling Cooling System

IMPORTANT: Avoid damage! Using incorrect coolant mixture can damage the radiator:

- Do not operate engine with plain water.
- Do not exceed a 50% mixture of coolant and water.
- Aluminum engine blocks and radiators require approved ethylene-glycol based antifreeze.

NOTE: John Deere COOL-GARD coolant is recommended when adding new coolant to the cooling system.

Follow the directions on the container for correct mixture ratio.

1. Allow radiator to cool.
2. Fill cooling system with recommended coolant:
3. Install and tighten radiator cap.
4. Run engine until it reaches operating temperature.
5. Stop engine.
6. Allow engine to cool. (Some coolant may be drawn into the radiator from the recovery tank during cool down.)
7. Raise hood.

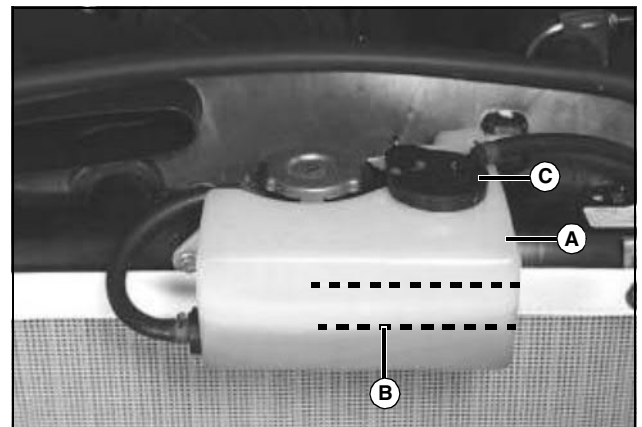

MX32645

8. Check recovery tank (A) coolant level:

- After engine cools, coolant level should be at the FULL COLD line (B) on the recovery tank.

9. Remove cap (C) from recovery tank to add coolant if necessary.

10. Lower hood.

Checking Radiator Hoses

1. Park machine safely. (See Parking Safely in the SAFETY section.)

SERVICE ENGINE

2. Allow engine to cool.
3. Raise hood.

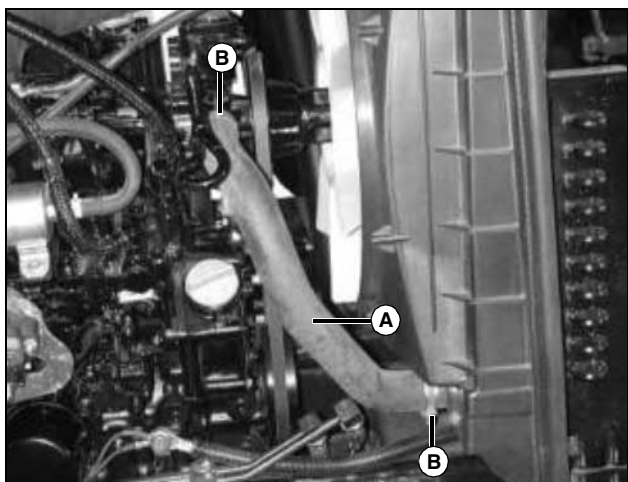

Picture Note: Tractor without cab shown.

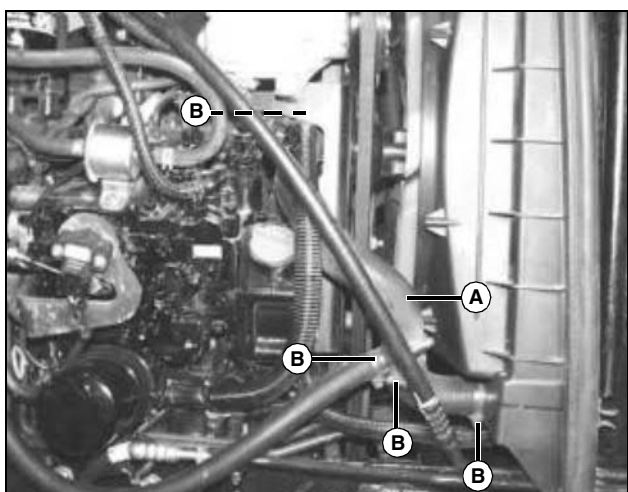

Picture Note: Tractor with cab shown.

4. Check lower radiator hose (A) for damage or cracking. Replace if necessary.
5. Tighten hose clamps (B) as needed.

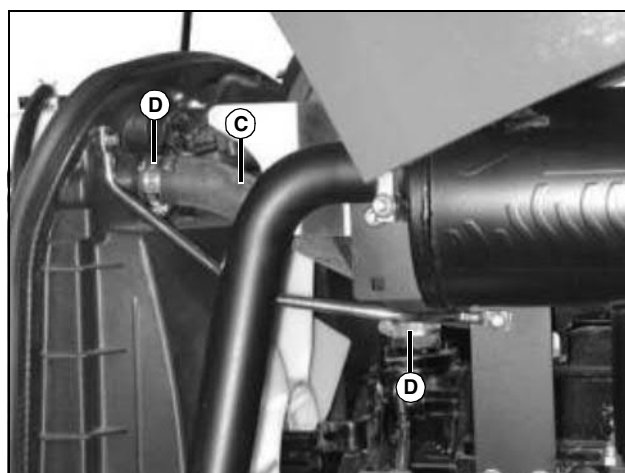

MX20938

6. Check upper radiator hose (C) for damage or cracking. Replace if necessary.
7. Tighten hose clamps (D) as needed.
8. Lower hood.

Adjusting Compressor Belt Tension



CAUTION: Avoid injury! Rotating parts can catch fingers, loose clothing, or long hair. Wait for engine and all moving parts to stop before leaving operator's station to adjust or service machine.

Checking Belt Tension

1. Park machine safely. (See Parking Safely in the SAFETY section.)
2. Raise hood.

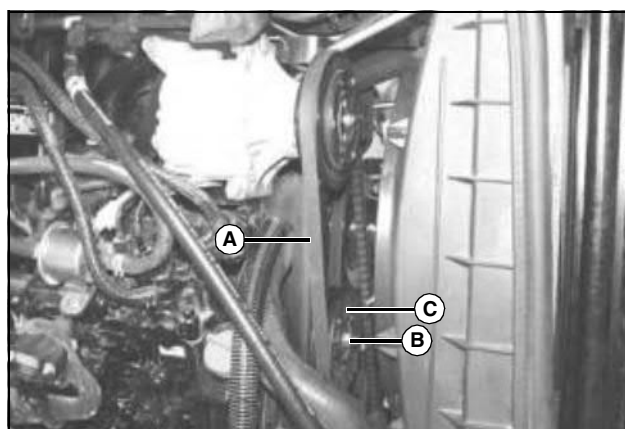

MX35883

3. Apply moderate thumb pressure to belt (A) halfway

SERVICE ENGINE

between the pulleys. Belt should deflect inward approximately 9 mm (3/8 in.).

4. Adjust belt tension if deflection is more or less than specified.

Adjusting Belt Tension

1. Loosen nut (B) on tensioner sheave (C).
2. Slide tensioner downward for more tension on belt or upward for less tension on belt.
3. Tighten nut on tensioner sheave and check belt tension. Adjust as necessary.
4. Lower hood.

Replacing Belt

NOTE: Replace alternator belt if excessive wear, damage or stretching is detected.

1. Raise hood.
2. Disconnect black negative (-) cable from battery.
3. Loosen nut (B) on tensioner sheave (C).
4. Slide tensioner upward to remove tension on belt, and remove belt from compressor sheave, engine sheave, and tensioner sheave.
5. Install new belt over engine sheave and then onto remaining sheaves.
6. Apply pressure to tensioner sheave (C) until tension is correct and tighten nut (B).
7. Check belt tension, and adjust as necessary.
8. Connect black negative (-) cable to battery.
9. Lower hood.

Servicing the Alternator Belt



CAUTION: Avoid injury! Rotating parts can catch fingers, loose clothing, or long hair. Wait for engine and all moving parts to stop before leaving operator's station to adjust or service machine.

Checking Belt Tension

1. Park machine safely. (See Parking Safely in the SAFETY section.) Allow engine to cool.
2. Raise hood.

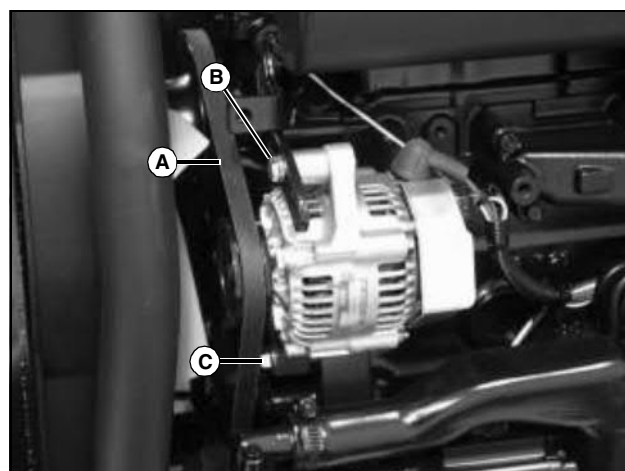

MX4765

Picture Note: Tractor without cab shown.

3. Apply moderate thumb pressure to belt (A) halfway between the pulleys. Belt should deflect inward approximately 9 mm (3/8 in.).
4. Adjust belt tension if deflection is more or less than specified.

Adjusting Belt Tension

1. Loosen top adjusting bolt:
 - For tractors without a cab, loosen top adjusting bolt (B).
 - For tractors with a cab, loosen top adjusting bolt and nut.
2. Loosen mounting bolt (C).
3. Apply outward pressure to alternator housing until tension is correct.
4. Tighten bolts (B) and (C).
5. Check belt tension.
6. Lower hood.

Replacing Belt

NOTE: Replace alternator belt if excessive wear, damage or stretching is detected.

1. Raise hood.
2. Disconnect black negative (-) cable from battery.

SERVICE ENGINE

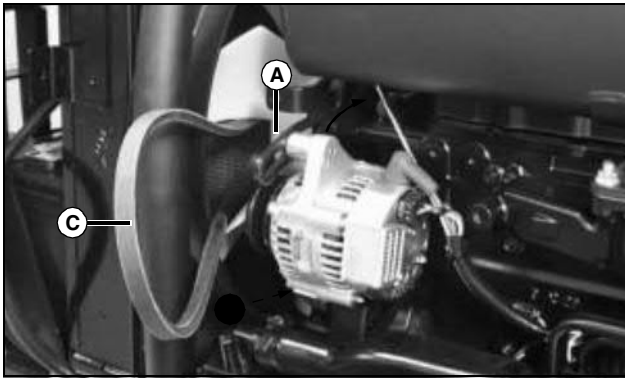

MX4773

3. Loosen top adjusting bolt:
 - For tractors without a cab, loosen top adjusting bolt (A).
 - For tractors with a cab, loosen top adjusting bolt and nut.
4. Loosen mounting bolt (B).
5. Apply inward pressure to alternator housing.
6. Remove belt (C) from alternator sheave, fan sheave and crankshaft sheave.
7. Route defective belt over fan and remove.
8. Install new belt over fan and onto sheaves.
9. Apply outward pressure to alternator housing until tension is correct.
10. Tighten bolts (A) and (B).
11. Check belt tension. Adjust as necessary.
12. Connect black negative (-) cable to battery.
13. Lower hood.

Servicing Water Separator Sediment Bowl



CAUTION: Avoid injury! Fuel vapors are explosive and flammable:

- Do not smoke while handling fuel.
- Keep fuel away from flames or sparks.
- Shut off engine before servicing.
- Cool engine before servicing.
- Work in a well-ventilated area.
- Clean up spilled fuel immediately.

NOTE: Change filter when fuel is low.

1. Park machine safely. (See Parking Safely in the SAFETY section.)

2. Allow engine to cool.

NOTE: Red ring in bottom of sediment bowl will float on water. If ring is floating, sediment bowl should be cleaned.

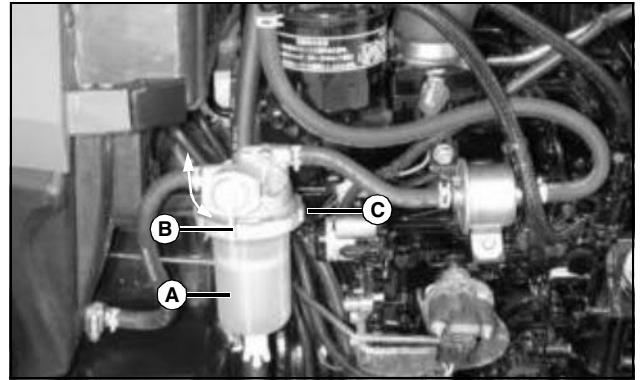

MX21816

3. Check for water and deposits in sediment bowl (A).
4. Clean sediment bowl and replace fuel filter if necessary.

Cleaning Water Separator Sediment Bowl

1. Close fuel shut-off valve (B).
 2. Position drain pan under sediment bowl to catch fuel spillage.
 3. Turn locking collar (C) counterclockwise to remove bowl.
 4. Remove and retain the plastic ring and spring from sediment bowl.
 5. Clean bowl, plastic ring, and spring.
 6. Install plastic ring and spring in original position in sediment bowl.
 7. Place sediment bowl and locking collar in position.
 8. Tighten locking collar to filter head to secure.
 9. Open fuel shut-off valve.
- NOTE: Fuel system is self bleeding.**
10. Crank engine to bleed fuel system.

SERVICE ENGINE

Cleaning Fuel Filter Sediment Bowl and Replacing Filter



CAUTION: Avoid injury! Fuel vapors are explosive and flammable:

- Do not smoke while handling fuel.
- Keep fuel away from flames or sparks.
- Shut off engine before servicing.
- Cool engine before servicing.
- Work in a well-ventilated area.
- Clean up spilled fuel immediately.

NOTE: Change filter when fuel is low.

1. Park machine safely. (See Parking Safely in the SAFETY section.) Allow engine to cool.
2. Raise hood.

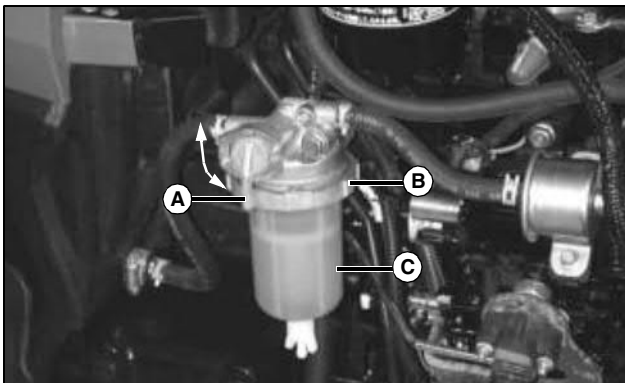

MX20939

3. Close fuel shut-off valve (A).
4. Position drain pan under fuel filter sediment bowl to catch fuel spillage.
5. Turn locking collar (B) counterclockwise to remove bowl (C).
6. Remove and discard the fuel filter.
7. Remove and retain the plastic ring and spring from sediment bowl.
8. Clean bowl, plastic ring, and spring.
9. Install plastic ring and spring in original position in sediment bowl.
10. Install new filter to filter head.
11. Place sediment bowl and locking collar in position.
12. Tighten locking collar to filter head to secure.
13. Open fuel shut-off valve.
14. Lower hood.

NOTE: Fuel system is self bleeding.

15. Crank engine to bleed fuel system.

Replacing Fuel Filter



CAUTION: Avoid injury! Fuel vapors are explosive and flammable:

- Do not smoke while handling fuel.
- Keep fuel away from flames or sparks.
- Shut off engine before servicing.
- Cool engine before servicing.
- Work in a well-ventilated area.
- Clean up spilled fuel immediately.

NOTE: Change filter when fuel is low.

1. Park machine safely. (See Parking Safely in the SAFETY section.)
2. Allow engine to cool.
3. Close fuel shut-off valve.

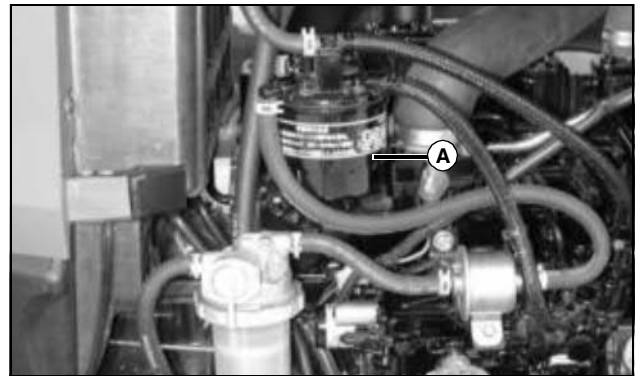

MX21816

4. Position drain pan under fuel filter (A) to catch fuel spillage.
5. Turn filter counterclockwise to remove and discard.
6. Apply fuel to surface of new filter gasket.
7. Install new filter to filter head. Tighten to one complete turn after filter contacts head.
8. Open fuel shut-off valve.

SERVICE ENGINE

Fuel Injection Pump

IMPORTANT: Avoid damage! Do not clean a warm or hot fuel injection pump with steam or water. Clean with compressed air if pump is not cooled.

NOTE: The fuel injection pump is calibrated by the engine manufacturer and should not require any adjustments.

If engine is hard to start, lacks power, or runs rough, see Troubleshooting Section of this manual.

After performing the check in the troubleshooting section and your engine is still not performing correctly, contact your John Deere dealer.

Fuel Injection Nozzles

IMPORTANT: Avoid damage! Do not service or remove fuel injection nozzles. Service life of injection nozzles may be shortened by overheating, improper operation, poor fuel quality, or excessive idling.

If injection nozzles are not working correctly or are dirty, engine will run poorly. See your John Deere dealer for service.

Cleaning Grille and Side Screens

IMPORTANT: Avoid damage! Grille and side screens must be clean to prevent engine from overheating and to allow adequate air intake.

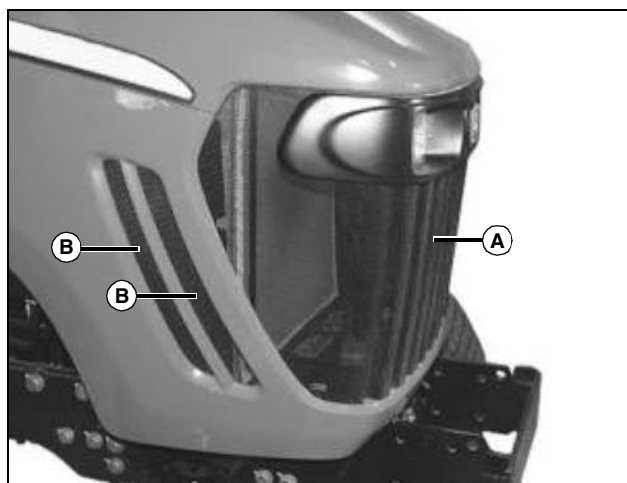

MX32640

1. Check grille (A) and side screens (B), on both sides, for dirt, grass clippings and debris.

2. Clean with a brush or cloth.

Cleaning Radiator Screen and Fins



CAUTION: Avoid injury! Compressed air can cause debris to fly a long distance.

- Clear work area of bystanders.
- Wear eye protection when using compressed air for cleaning purposes.
- Reduce compressed air pressure to 210 kPa (30 psi).

IMPORTANT: Avoid damage! The radiator cooling screen must be clean to prevent engine from overheating and to allow adequate air intake.

1. Park machine safely. (See Parking Safely in the SAFETY section.)
2. Raise hood.

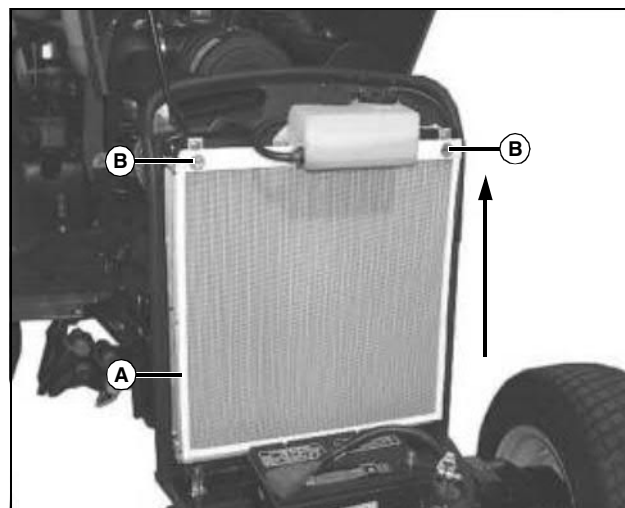

MX32637

Picture Note: Tractor without cab shown.

3. Lift and remove radiator screen (A) off of clips (B) on top of radiator.
4. Clean screen with compressed air, brush or cloth, or screen may be carefully washed to remove dirt and debris.

SERVICE ENGINE

IMPORTANT: Avoid damage! Reduced air intake can cause overheating. Keep radiator cooling fins clean.

Do not use pressure washers to clean radiator cooling fins. The force produced by pressure washers will damage the radiator and cooling fins.

Reduce compressed air pressure to 210 kPa (30 psi) when cleaning radiator and cooling fins. Spray compressed air straight into radiator. Do not spray radiator on an angle or cooling fins will be bent.

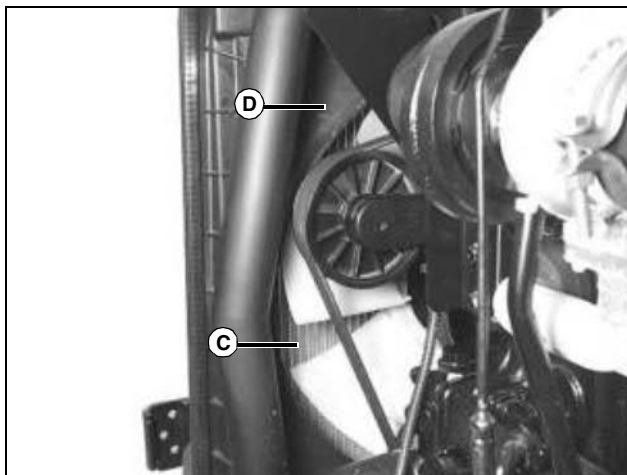

MX32639

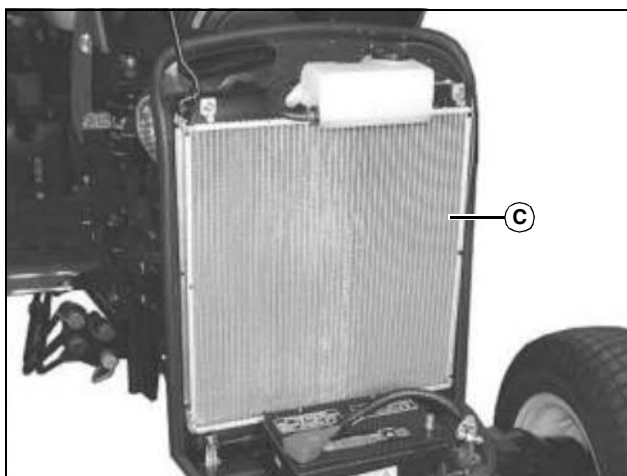

MX32638

5. Remove all dirt and debris from radiator fins (C), and fan shroud (D) using compressed air or water.
6. Install radiator screen.
7. Lower hood.

SERVICE TRANSMISSION

Transmission and Hydraulic Oil

IMPORTANT: Avoid damage! Use recommended oil only. Do not use engine oil or "Type F" automatic transmission fluid.

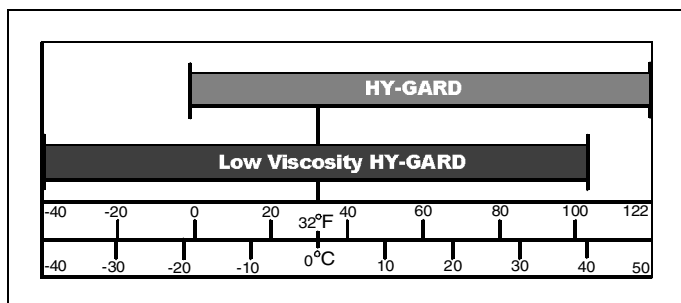

Choose oil viscosity based on the expected air temperature range during the period between oil changes.

John Deere Low Viscosity HY-GARD™ transmission/hydraulic fluid is recommended. John Deere HY-GARD transmission/hydraulic fluid may also be used for temperatures above -18° C (0° F).

Other oils may be used if they meet John Deere standard JDM J20C or J20D.

Checking Front Axle Oil Level

IMPORTANT: Avoid damage! Allow oil one hour to settle before checking level to ensure accurate dipstick reading. Repeat oil level check after several hours of operation.

1. Park machine safely. (See Parking Safely in the SAFETY section.) Allow machine to cool down for at least one hour.

IMPORTANT: Avoid damage! Dirt and debris in oil may cause damage to the transaxle. Clean area around opening before removing dipstick.

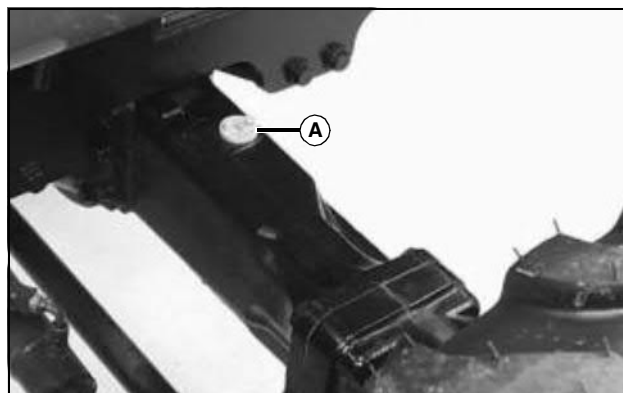

MX4769

2. Loosen and remove dipstick (A) located on right side of front axle.

3. Wipe dipstick clean with a rag. Install and tighten dipstick.



MX4775

4. Remove dipstick again. Oil level should be indicated on the dipstick, but not above the full line (B). If oil level is low:

- Add recommended oil through dipstick fill opening until oil level is correct.
- Install and tighten dipstick.

5. Check front axle oil level again after the first several hours of operation.

Changing Front Axle Oil

- Operate machine to warm front axle oil.
- Park machine safely. (See Parking Safely in the SAFETY section.)

SERVICE TRANSMISSION

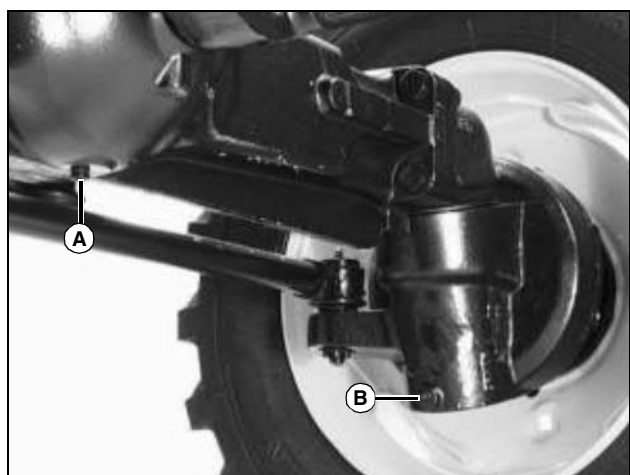

MX4776

3. Position drain pan under differential drain plug (A).

NOTE: The front axle contains approximately 5.0 L (1.3 gal) of oil.

4. Remove differential drain plug and allow oil to drain.
5. Position drain pan under axle drain plug (B) on both sides of front axle.
6. Remove axle drain plugs and allow oil to drain.
7. Install and tighten all three drain plugs after all oil has drained.

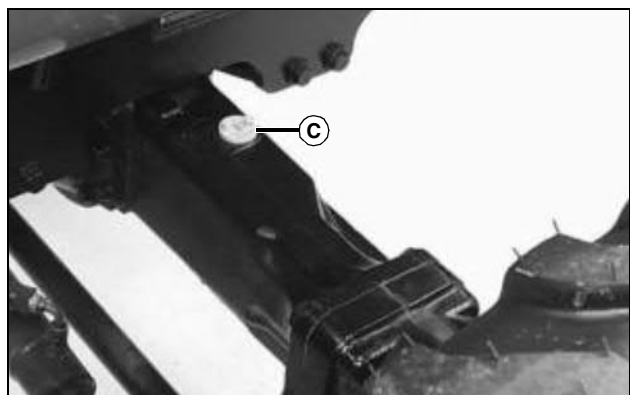

MX4769

8. Remove dipstick (C) located on right side of front axle.
9. Add approximately 5.0 L (1.3 gal) of recommended oil into dipstick filler opening.
10. Install and tighten dipstick.

IMPORTANT: Avoid damage! Allow oil one hour to settle before checking level to ensure accurate dipstick reading. Repeat oil level check after several hours of operation.

11. Check front axle oil level.

Adjusting Front Axle Thrust Bolt Torque

NOTE: Adjust bolt torque at the required service interval to prevent excessive forward and rearward movement of the front axle.

1. Park machine safely. (See Parking Safely in the Safety section.)



CAUTION: Avoid injury! The machine can fall or slip from an unsafe lifting device or supports.

- Use a safe lifting device rated for the load to be lifted.
- Lower machine onto jack stands or other stable supports and block wheels before servicing.

2. Raise front axle off ground to take machine weight off the front axle.

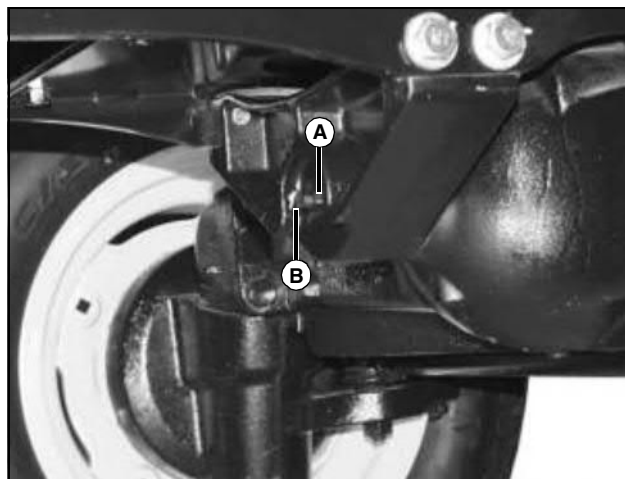

MX32689

3. Loosen jam nut (A).
4. Tighten bolt (B) to 32 N•m (24 lb-ft). Do not overtighten.
5. Tighten back the jam nut.
6. Lower front axle back to ground.

Checking Transmission Oil Level

IMPORTANT: Avoid damage! Allow oil one hour to settle before checking level to ensure accurate dipstick reading. Repeat oil level check after several hours of operation.

1. Park machine safely. (See Parking Safely in the SAFETY section.) Allow machine to cool down for at least one hour.

SERVICE TRANSMISSION



MX23853

2. Remove dipstick (A) located behind operator's seat. Wipe dipstick with a clean rag.
3. Install dipstick.

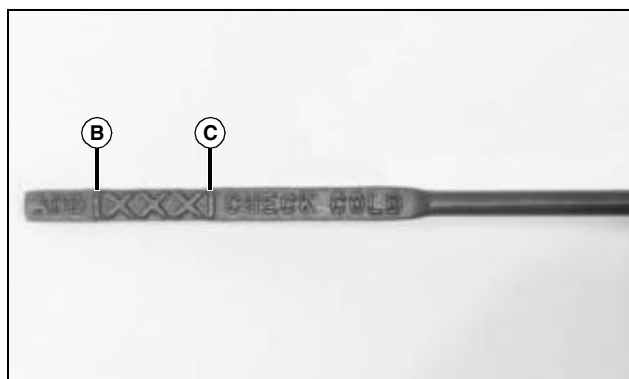

MX4777

4. Remove dipstick and check oil level. Oil level should be between the minimum (B) and maximum (C) lines.

IMPORTANT: Avoid damage! Help prevent dirt and other contaminants from entering the transmission. Clean area around fill cap before removing.

Do not overfill transmission. Oil expands during operation and could overflow.

5. If oil level is low:
 - Remove oil fill cap (D). Add recommended oil at fill cap location.
6. Install and tighten fill cap.

Changing Transmission Oil and Hydraulic Suction Oil Filter



CAUTION: Avoid injury! Touching hot surfaces can burn skin. The engine, components, and fluids will be hot if the engine has been running. Allow the engine to cool before servicing or working near the engine and components.

IMPORTANT: Avoid damage! If there is evidence of severe oil contamination, it may be necessary to change the oil several times. Contamination of hydraulic fluid could cause transmission damage or failure.

Severe or unusual conditions may require a more frequent service interval.

1. Run engine a few minutes to warm the transmission oil.
2. Park machine safely. (See Parking Safely in the SAFETY section.)

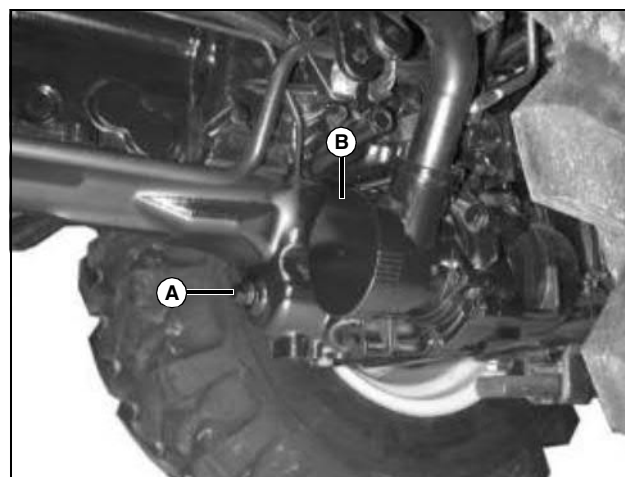

MX20941

3. Position drain pan under transmission drain plug (A) and suction filter assembly on left side of transmission. Remove plug and allow oil to drain.
4. Remove cover (B) and allow oil to drain.
5. Remove filter assembly and replace with new filter assembly.
6. Install cover.
7. Install transmission drain plug.

SERVICE TRANSMISSION

NOTE: The inline hydraulic filter should be cleaned at the same time the transmission oil is changed, but not every time. See **SERVICE INTERVALS**.

12. Stop engine.
13. Check transmission oil level.

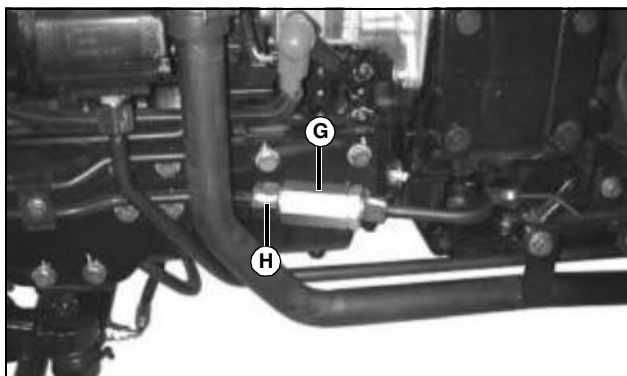

MX20942

8. Clean inline hydraulic filter:
 - a. Position drain pan under filter (G).
 - b. Remove filter from lines.
 - c. Remove nut (H) with internal element from case.
 - d. Clean case and internal element with a mild solvent. Allow to dry.

NOTE: Direction-of-flow arrow on filter points toward transmission fitting.

- e. Assemble and install hydraulic filter assembly.

IMPORTANT: Avoid damage! Help prevent dirt and other contaminants from entering the transmission. Clean area around fill cap before removing.

Do not overfill transmission. Oil expands during operation and could overflow.



MX23853

9. Remove fill cap (I).
10. Add recommended oil into filler opening.
11. Start engine. Check for oil leaks around filter base and drain plugs.

SERVICE STEERING & BRAKES

Tractor Without Cab

Adjusting Brake (Pedals)

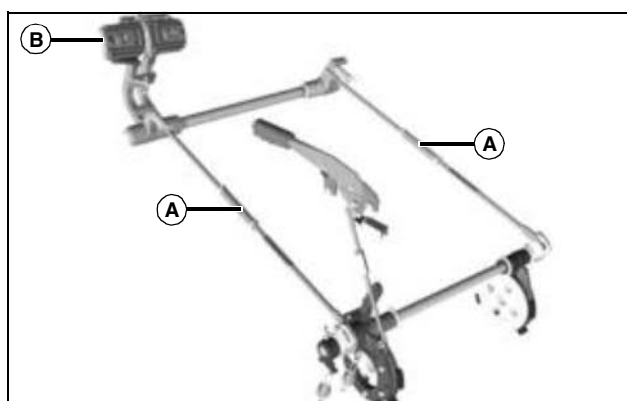

MX21773

1. Loosen jam nuts on brake linkage and adjust each turnbuckle (A) so there is about 22 - 30 mm (0.87 - 1.2 in.) of free play at the pedals (B).
2. Check to be sure free play is about the same for both pedals.
3. Tighten jam nuts to lock in place.
4. Adjust park brake linkage.

Adjusting Park Brake

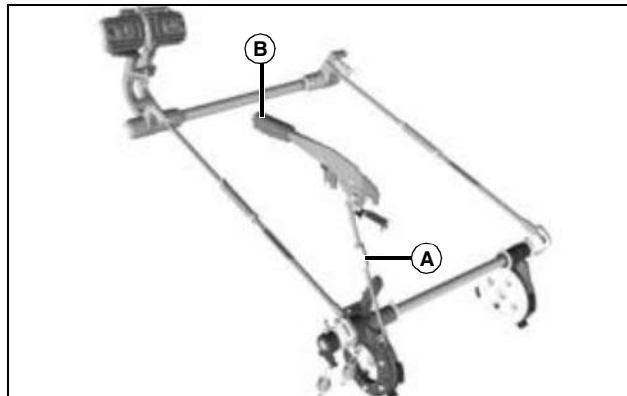

MX21773

1. With the brake (pedals) properly adjusted (but not actuated), adjust clevis (A) of the park brake linkage so there is 2 clicks of free play in the linkage.
2. The park brake lever (B) should begin to lock at 3 clicks of lever travel, and the brakes should be fully locked at 6 - 8 clicks.

Tractor With Cab

1. Lift both rear wheels several inches off the ground.
2. Place a visible white horizontal line on the wheels or

hubs to observe wheel RPM during setup.

NOTE: If the two rear transmission brake bell crank springs (A) are attached to the ROPS, proceed to the next step. If not, install missing spring(s).

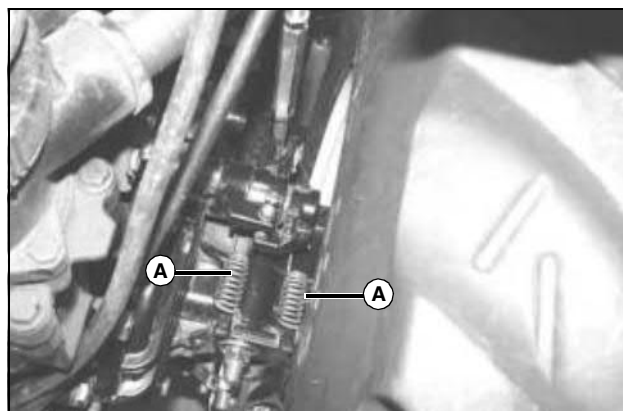

MX35885

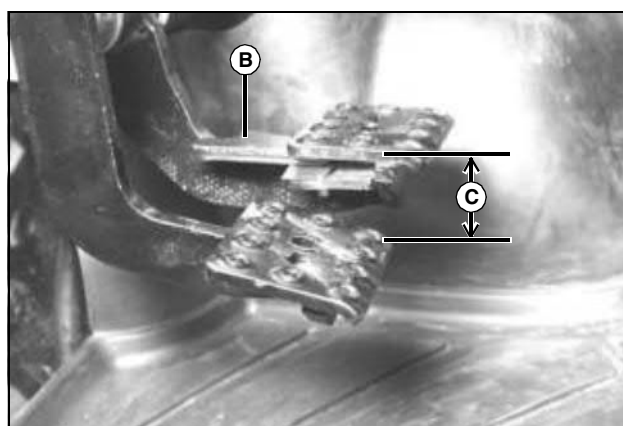

MX35884

3. Rotate lever (B) clockwise to unlock brake pedal latch.
4. Push/pull on the pedal foot pad to make sure they are traveling at an equal distance, about 40 mm (1-37/64 in.) (C) from the starting point.
5. If both pedals are traveling an equal distance, then proceed to the next step. If not, adjustment is necessary:

SERVICE STEERING & BRAKES

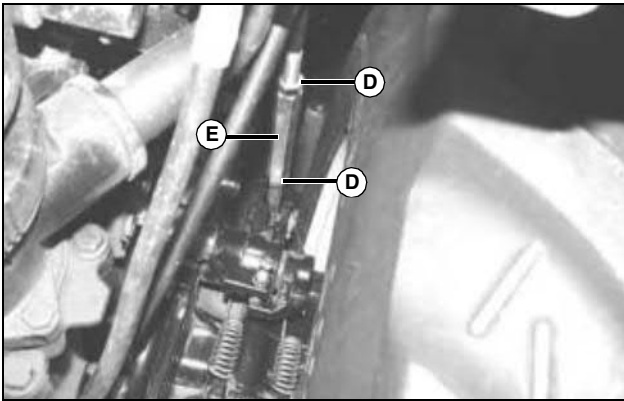

MX35885

Picture Note: Left rear shown.

- To adjust lift pedal linkage, loosen both jam nuts (D) away from the turnbuckle (E). Turn turnbuckle clockwise to increase pedal travel distance, and counterclockwise to decrease pedal travel distance.
 - Adjust pedal linkage on opposite side, so both pedals travel the same distance of approximately 40 mm (1-37/64 in.) from the starting point.
6. Lock the pedals together.
 7. Start the tractor, place the transmission in B-2 position, and set the engine throttle speed to 2000 RPM.
 8. Press down on brake pedals.
 9. Both wheel hubs should slow down at the same time (or similar) rate of speed. If not, adjust turnbuckles until they slow down at about the same rate of speed.
 10. Tighten both jam nuts against the turnbuckles adjusted.
 11. Lower tractor.

SERVICE ELECTRICAL

WARNING: Battery posts, terminals and related accessories contain lead and lead components, chemicals known to the State of California to cause cancer and reproductive harm. **Wash hands after handling.**

Service the Battery Safely

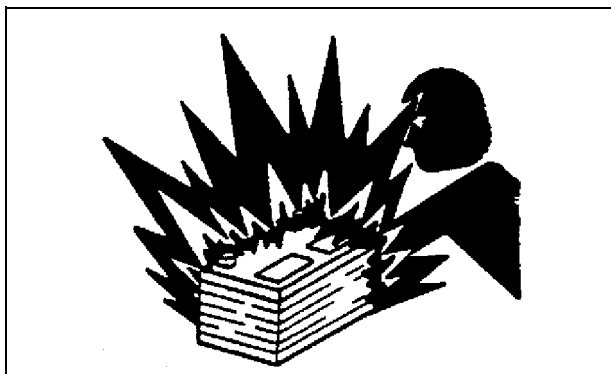

CAUTION: Avoid injury! Battery electrolyte contains sulfuric acid. It is poisonous and can cause serious burns:

- Wear eye protection and gloves.
- Keep skin protected.
- If electrolyte is swallowed, get medical attention immediately.
- If electrolyte is splashed into eyes, flush immediately with water for 15-30 minutes and get medical attention.
- If electrolyte is splashed onto skin, flush immediately with water and get medical attention if necessary.

The battery produces a flammable and explosive gas. The battery may explode:

- Do not smoke near battery.
- Wear eye protection and gloves.
- Do not allow direct metal contact across battery posts.
- Remove negative cable first when disconnecting.
- Install negative cable last when connecting.

Checking Battery Electrolyte Level

NOTE: Add only distilled water to replace battery electrolyte.

1. Park the machine safely. (See Parking Safely in the SAFETY section.)
2. Remove battery cell caps. Make sure cap vents are not plugged.

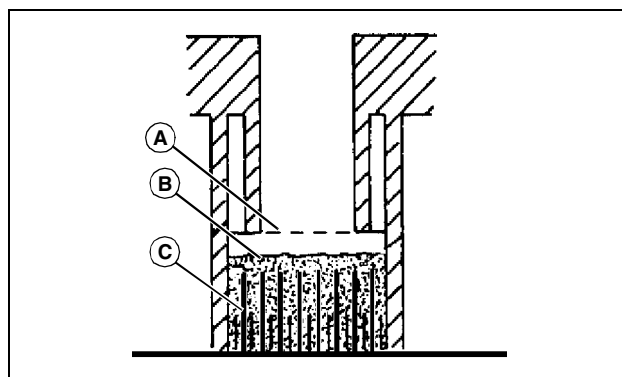

M39772

3. Check electrolyte level. Electrolyte (B) should be approximately halfway between bottom of filler neck (A) and top of plates (C).

IMPORTANT: Avoid damage! Do not overfill battery. Electrolyte can overflow when battery is charged and cause damage.

4. Add only distilled water if necessary.
5. Install battery cell caps.

Removing and Installing Battery

Removing:

1. Park machine safely. (See Parking Safely in the SAFETY Section.)
2. Raise hood.

SERVICE ELECTRICAL

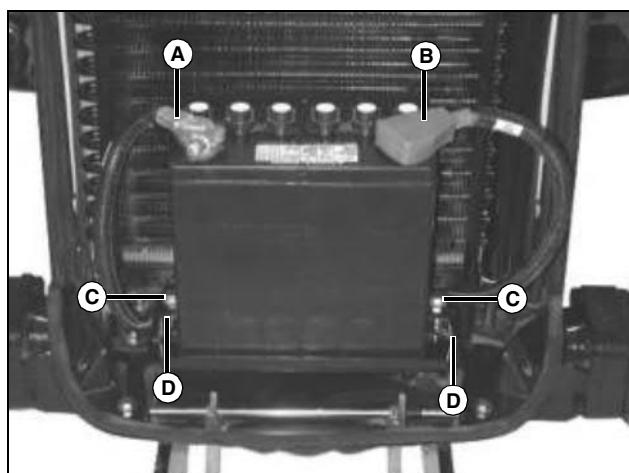

MX20943

3. Disconnect negative (-) battery cable (A).
4. Push red cover (B) back away from positive (+) battery cable and remove cable from battery.
5. Loosen bolts (C) and remove battery compartment hold-down brackets (D).
6. Remove battery.

Installing:

1. Install battery into machine.
2. Connect positive (+) cable to battery positive (+) terminal first, then negative (-) cable to battery negative (-) terminal.
3. Apply spray lubricant to terminals to prevent corrosion.
4. Slide red cover over positive battery cable.
5. Install battery compartment hold-down brackets and bolts. Do not overtighten.
6. Lower hood.

Cleaning Battery and Terminals

1. Park machine safely. (See Parking Safely in the SAFETY section.)
2. Disconnect and remove battery.
3. Wash battery with solution of four tablespoons of baking soda to one gallon of water. Be careful not to get the soda solution into the cells.
4. Rinse the battery with plain water and dry.
5. Clean terminals and battery cable ends with wire brush until bright.
6. Install battery.
7. Attach cables to battery terminals using washers and nuts.

8. Apply spray lubricant to terminal to prevent corrosion.

Using Booster Battery



CAUTION: Avoid injury! The battery produces a flammable and explosive gas. The battery may explode:

- Do not smoke or have open flame near battery.
- Wear eye protection and gloves.
- Do not jump start or charge a frozen battery. Warm battery to 16°C (60°F).
- Do not connect the negative (-) booster cable to the negative (-) terminal of the discharged battery. Connect at a good ground location away from the discharged battery.

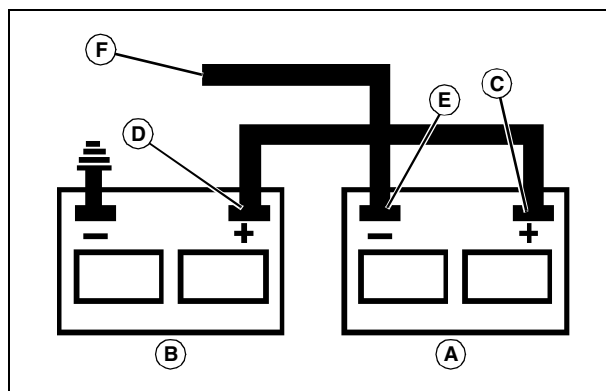

M71044

A - Booster Battery

B - Disabled Vehicle Battery

1. Connect positive (+) booster cable to booster battery (A) positive (+) post (C).
2. Connect the other end of positive (+) booster cable to the disabled vehicle battery (B) positive (+) post (D).
3. Connect negative (-) booster cable to booster battery negative (-) post (E).

IMPORTANT: Avoid damage! Electric charge from booster battery can damage machine components. Do not install negative booster cable to machine frame. Install only to the engine block.

Install negative booster cable away from moving parts in the engine compartment, such as belts and fan blades.

4. Connect the other end (F) of negative (-) booster cable to a metal part of the disabled machine engine block away

SERVICE ELECTRICAL

from battery.

5. Start the engine of the disabled machine and run machine for several minutes.
6. Carefully disconnect the booster cables in the exact reverse order: negative cable first and then the positive cable.

Replacing Headlight Bulb

CAUTION: Avoid injury! Halogen light bulb contains gas under pressure. The bulb may shatter if the glass is scratched or dropped. Wear eye protection and handle bulb with care when replacing.

1. Park machine safely. (See Parking Safely in the SAFETY section.)
2. Raise hood.

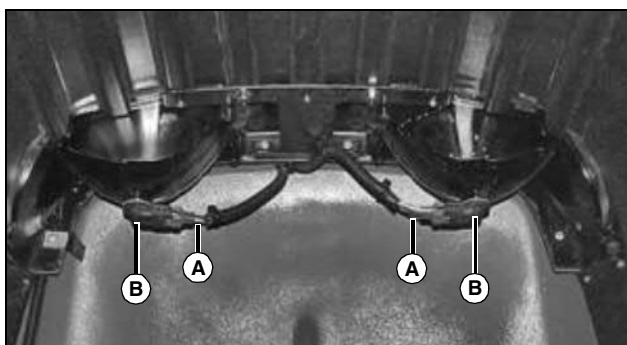

3. Disconnect wire harness (A) from defective headlight bulb assembly.
4. Rotate bulb assembly (B) to remove from housing socket.

NOTE: Do not touch the new bulb assembly with bare hands. Use a clean cloth to install, and hold the bulb only by the connector.

5. Install new bulb assembly into housing socket and rotate to lock in place.
6. Connect wire harness to bulb assembly.
7. Check operation of headlights.
8. Lower hood.

Replacing Light Bulbs (Tractor With Cab)

CAUTION: Avoid injury! Halogen light bulb contains gas under pressure. The bulb may shatter if the glass is scratched or dropped. Wear eye protection and handle bulb with care when replacing.

Dome Light Bulb

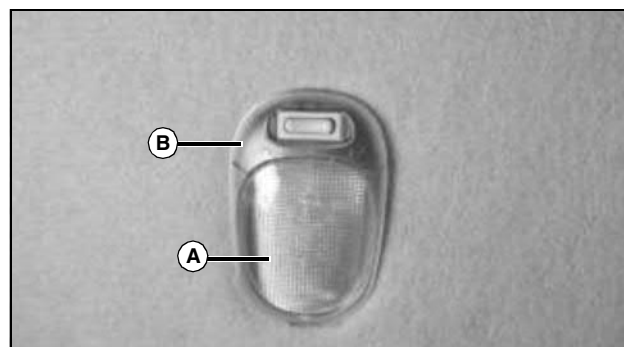

1. Remove cover (A) from housing (B) using a screwdriver.

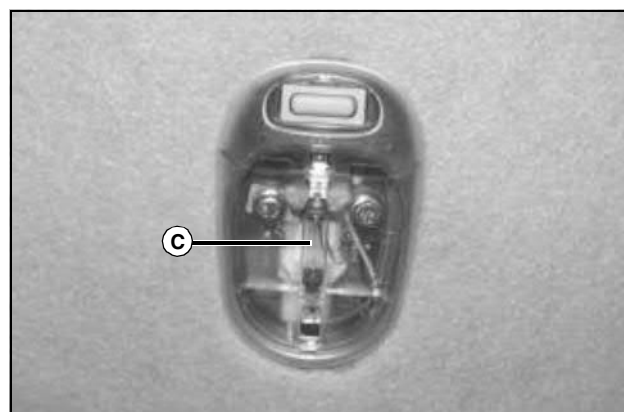

2. Pull bulb (C) from socket.
3. Install new bulb and cover.

SERVICE ELECTRICAL

Taillight Bulb

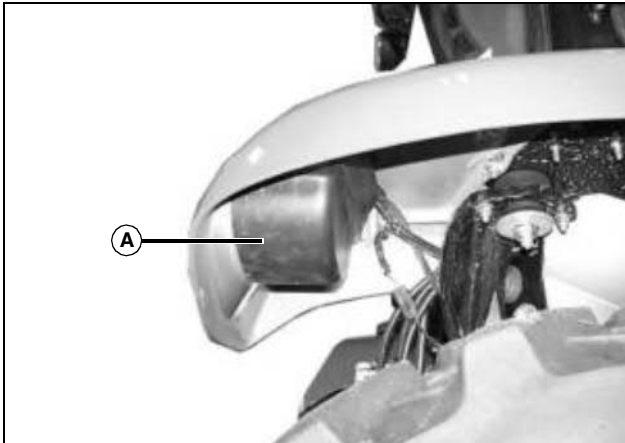

MX35858

Picture Note: Left rear shown.

1. Remove four screws and cover (A) under fender.



MX35874

2. Rotate socket (B) and remove from housing.
3. Install new bulb and socket in housing.
4. Install cover and screws to fender.

Rotary Beacon Light Bulb

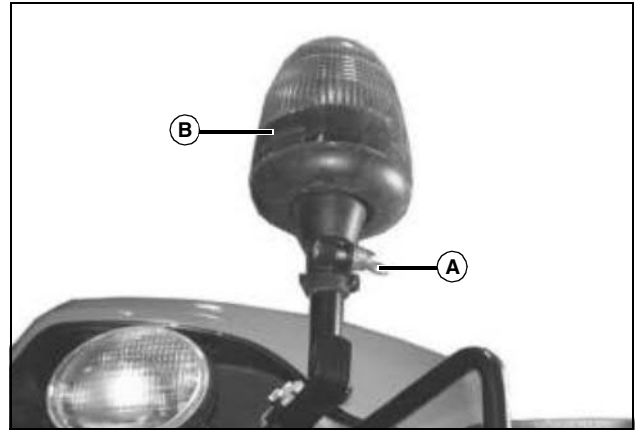

MX35861

1. Loosen wing nut (A) and remove rotary beacon light assembly.

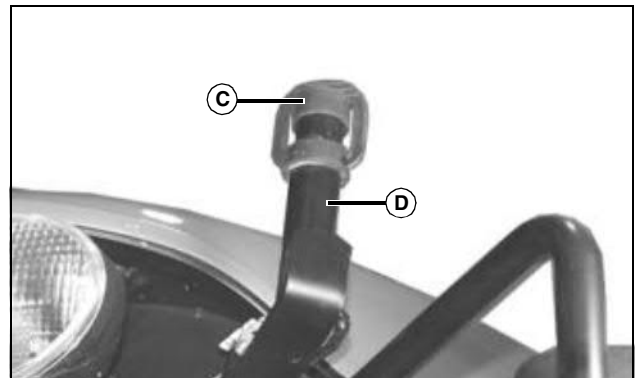

MX35862

2. Install rubber cap (C) on mounting shaft (D).

SERVICE ELECTRICAL

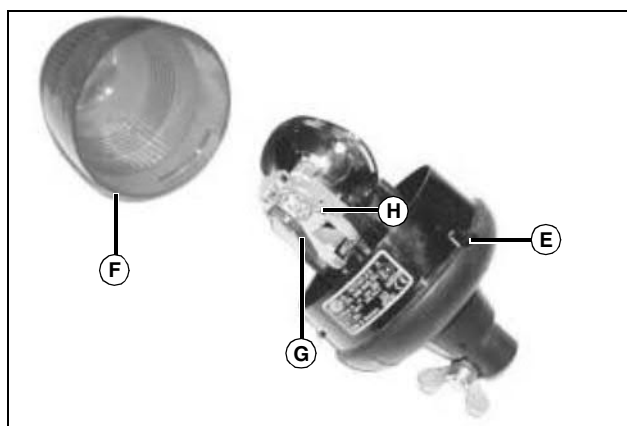

MX35863

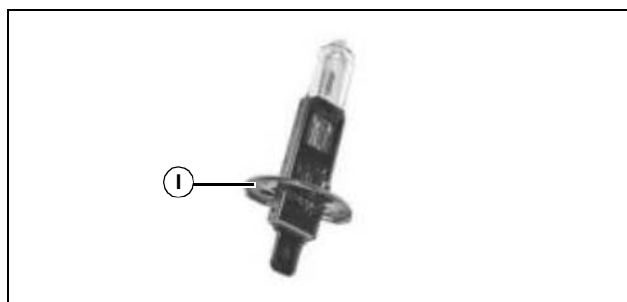

MX35864

3. Depress tab (E) and rotate lens (F) counterclockwise to remove.
4. Pull tab (G) away from bulb.
5. Unlatch retaining spring (H) and remove light bulb (I).
6. Install new bulb in reverse order of removal.

Warning Light Bulb

NOTE: Bulb replacement procedures for front and rear warning lights are similar. On rear warning light, bracket for the work light is also removed when removing two screws. Front right side shown.

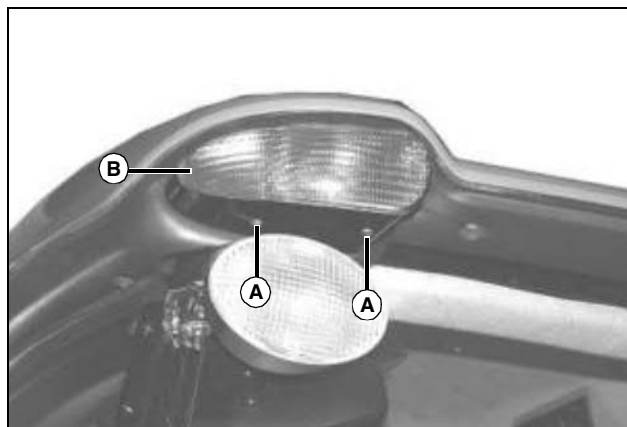

MX35878

1. Remove two hex socket head screws (A) and lens assembly (B) from cab roof panel.

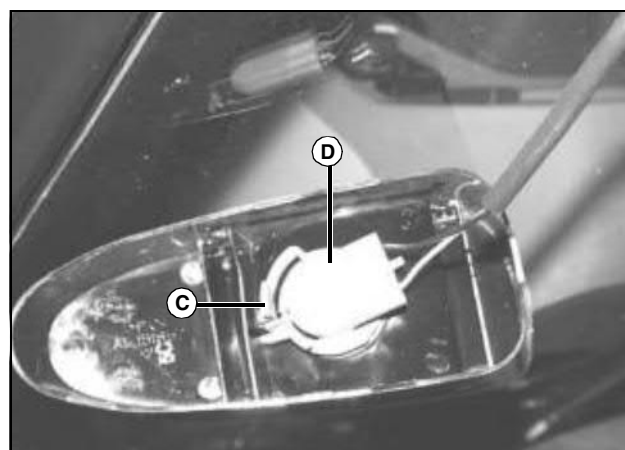

MX35879

2. Push in tab (C) and rotate socket (D) counterclockwise to remove from housing. Install new bulb into socket.
3. Install socket, and rotate clockwise to lock tab into position.
4. Install housing with two hex socket head screws.

Work Light Bulb

NOTE: Bulb replacement procedures for front and rear work lights and optional auxiliary work lights are the same. Rear left side shown.

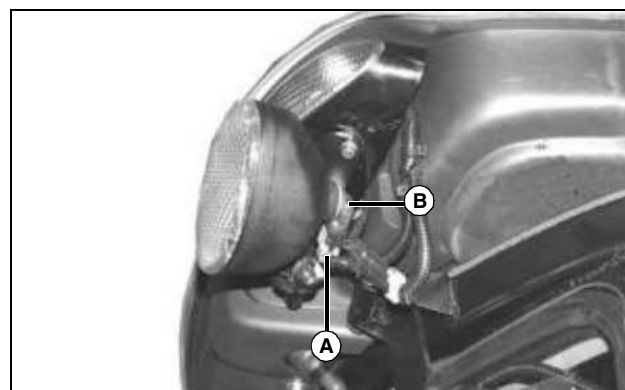

MX35880

1. Disconnect wiring harness connector (A).
2. Rotate bulb base (B) counterclockwise and remove from housing.
3. Install new bulb into housing and rotate bulb base clockwise to install.
4. Connect wiring harness connector.

Replacing Light Bulbs (Tractor Without Cab)

Replacing Taillight Bulb

1. Park machine safely. (See Parking Safely in the SAFETY section.)

SERVICE ELECTRICAL

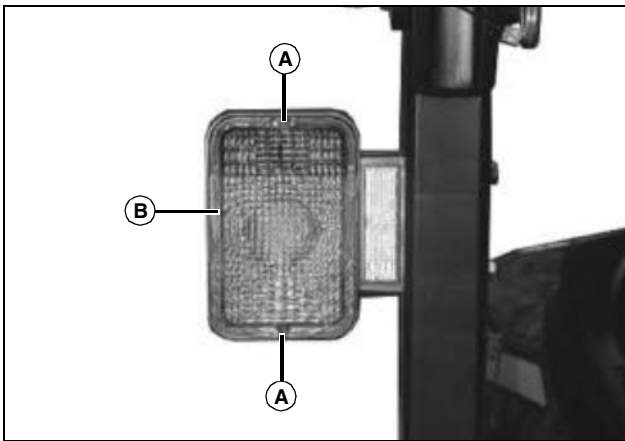

MX20946

2. Remove two screws (A) and lens (B).

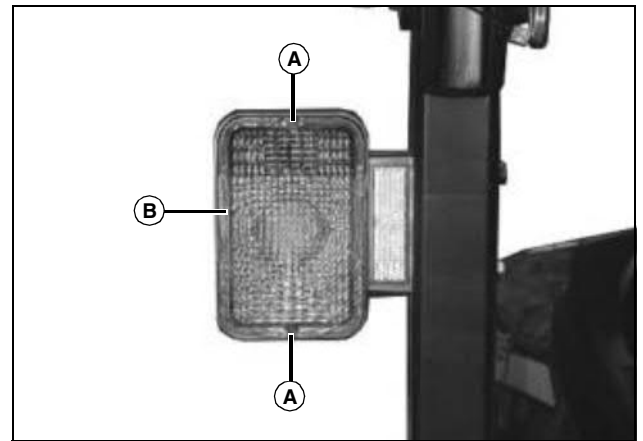

MX20946

2. Remove two screws (A) and lens (B).

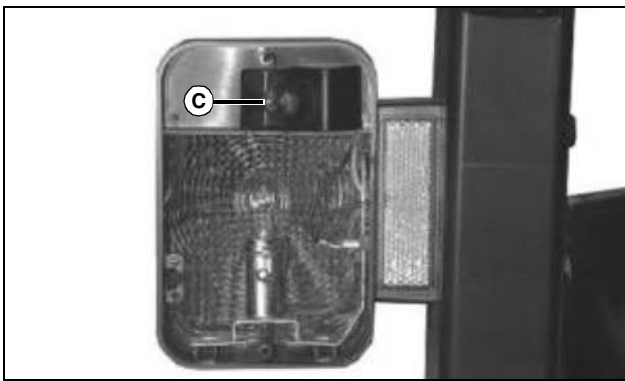

MX20947

3. Pull bulb (C) straight out to remove. Do not twist bulb.
4. Push new bulb into socket.
5. Check operation of taillights.
6. Install lens and screws.

Replacing Warning Light Bulb

1. Park machine safely. (See Parking Safely in the SAFETY section.)

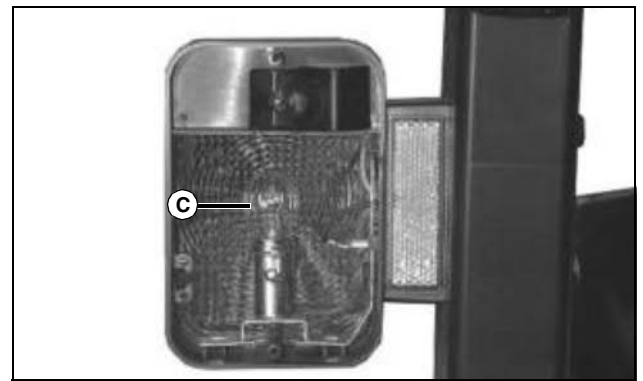

MX20947

3. Push down and rotate bulb (C) to remove. Do not twist bulb.
4. Push down and rotate new bulb into socket.
5. Check operation of warning lights.
6. Install lens and screws.

Replacing Fuses

IMPORTANT: Avoid damage! The electrical system may be damaged if incorrect replacement fuses are used. Replace the bad fuse with a fuse of the same amp rating.

All Tractors

1. Park machine safely. (See Parking Safely in the SAFETY section.)

SERVICE ELECTRICAL

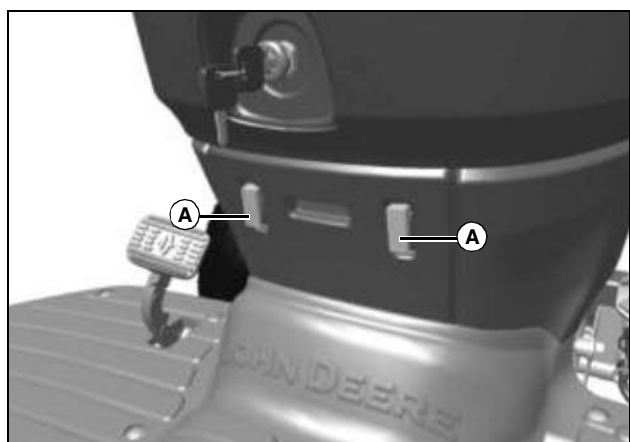

MX32668

2. Raise two levers (A) and lower fuse block access cover.
3. Fuse identification:

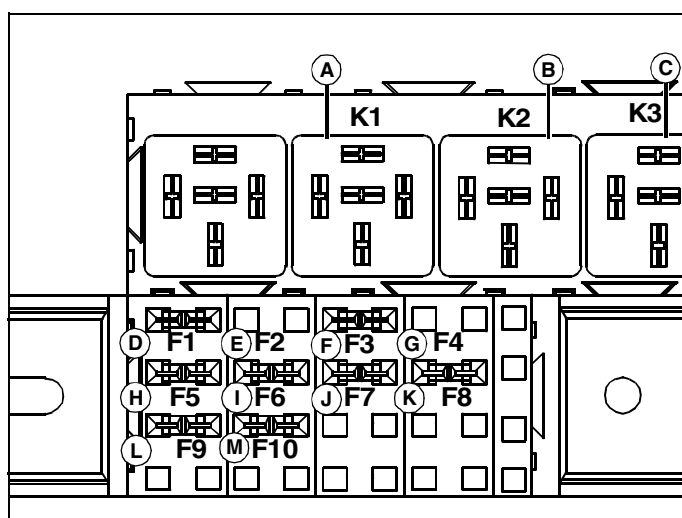

Position	Circuit	Fuse Size
K1 (A)	Fuel Relay	N/A
K2 (B)	Start Relay	N/A
K3 (C)	Intake Manifold Heater Relay	N/A
F1 (D)	Key Switch	30 amp
F2 (E)	Blank	N/A
F3 (F)	Light Switch	30 amp
F4 (G)	Blank	N/A
F5 (H)	Switched Power	20 amp
F6 (I)	Work Light	20 amp
F7 (J)	Headlight	20 amp

Position	Circuit	Fuse Size
F8 (K)	Blank	N/A
F9 (L)	Electronic Drive Controller (eHydro only)	10 amp
F10 (M)	Diverter Kit (Optional)	20 amp

4. Pull defective fuse from socket.
5. Push new fuse into socket.
6. Install fuse block access cover.

Tractors With Cabs

1. Park machine safely. (See Parking Safely in the SAFETY section.)



MX35866

2. Pull forward and out on the access cover (A) to remove the cover.
3. Fuse identification:

SERVICE ELECTRICAL

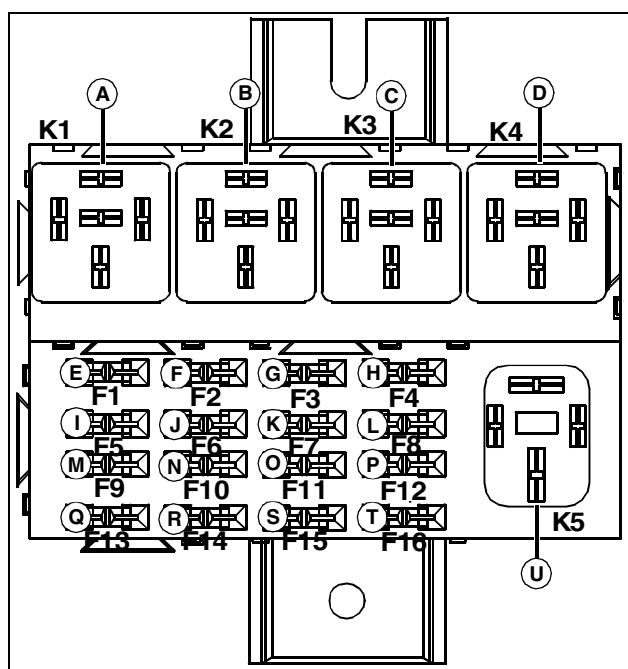

MIF

Position	Circuit	Fuse Size
F12 (P)	Headlights	15 amp
F13 (Q)	Work Lights	30 amp
F14 (R)	Trailer Power Option	30 amp
F15 (S)	Blank	N/A
F16 (T)	Power Outlet	15 amp
K5 (U)	Intake Manifold Heater Relay	N/A

4. Pull defective fuse from socket.
5. Push new fuse into socket.
6. Install fuse block access cover.

Position	Circuit	Fuse Size
K1 (A)	Fuel Relay	N/A
K2 (B)	Start Relay	N/A
K3 (C)	Front Work Light Relay	N/A
K4 (D)	Rear Work Light Relay	N/A
F1 (E)	Key Switch	30 amp
F2 (F)	Main Light Switch/Horn	30 amp
F3 (G)	HVAC Blower 1	20 amp
F4 (H)	HVAC Blower 2	20 amp
F5 (I)	Ignition Run Power	15 amp
F6 (J)	Display Power	10 amp
F7 (K)	Marker Lights 1	15 amp
F8 (L)	Marker Lights 2	15 amp
F9 (M)	Transmission Controls	10 amp
F10 (N)	Wipers	20 amp
F11 (O)	Air Seat/Diverter Options	20 amp

SERVICE MISCELLANEOUS

Using Proper Fuel (Diesel)

Use the proper diesel fuel to help prevent decreased engine performance and increased exhaust emissions. Failure to follow the fuel requirements listed below can void your engine warranty.

Consult your local fuel distributor for properties of the diesel fuel in your area.

In general, diesel fuels are blended to satisfy the low temperature requirements of the geographical area in which they are marketed.

Diesel fuels specified to EN 590 or ASTM D975 are recommended.

Required fuel properties

In all cases, the fuel shall meet the following properties:

Cetane number of 45 minimum. Cetane number greater than 50 is preferred, especially when temperatures are below -20°C (-4°F) or elevations above 1500 m (5000 ft).

Cold Filter Plugging Point (CFPP) should be at least 5°C (9°F) below the expected lowest temperature or **Cloud Point** below the lowest ambient temperature.

Fuel lubricity should pass a maximum scar diameter of 0.45 mm as measured by ASTM D6079 or ISO 12156-1.

IMPORTANT: Avoid damage! Improper fuel additive usage may cause damage on fuel injection equipment of diesel engines.

If a fuel of low or unknown lubricity is used, addition of John Deere PREMIUM DIESEL FUEL CONDITIONER at the specified concentration is recommended.

Sulfur content

- Diesel fuel quality and fuel sulfur content must comply with all existing emissions regulations for the area in which the engine operates.
- Use of diesel fuel with sulfur content less than 0.05% (500 ppm) is required.
- Use of ultra-low sulfur diesel fuel with sulfur content less than 0.0015% (15 ppm) is acceptable.

IMPORTANT: Avoid damage! Do not mix diesel engine oil or any other type of lubricating oil with diesel fuel.

Using Bio-Diesel Fuel

Bio-diesel fuels may be used only if the bio-diesel fuel properties meet the latest edition of ASTM D6751, EN14214, or equivalent specification.

The current maximum allowable bio-diesel concentration is a 5% blend (also known as B5) in petroleum diesel fuel.

To learn of any changes to the recommendations for bio-diesel usage with your diesel engine, ask your John Deere dealer or reference the Services and Support link on the John Deere Commercial and Consumer Equipment website.

Handling and Storing Diesel Fuel



CAUTION: Avoid injury! Handle fuel carefully. Do not fill the fuel tank when engine is running. Do not smoke while you fill the fuel tank or service the fuel system.

IMPORTANT: Avoid damage! Do not use galvanized containers—diesel fuel stored in galvanized containers reacts with zinc coating in the container to form zinc flakes. If fuel contains water, a zinc gel will also form. The gel and flakes will quickly plug fuel filters and damage fuel injectors and fuel pumps.

- Fill the fuel tank at the end of each day's operation to prevent water condensation and freezing during cold weather.

IMPORTANT: Avoid damage! The fuel tank is vented through the filler cap. If a new cap is required, always replace it with an original vented cap.

- When fuel is stored for an extended period or if there is a slow turnover of fuel, add a fuel conditioner to stabilize the fuel and to prevent water condensation. Contact your fuel supplier for recommendations.

SERVICE MISCELLANEOUS

Filling Fuel Tank

CAUTION: Avoid injury! Fuel vapors are explosive and flammable:

- Shut engine off before filling fuel tank.
- Allow engine to cool before refueling.
- Do not smoke while handling fuel.
- Keep fuel away from flames or sparks.
- Fill fuel tank outdoors or in well ventilated area.
- Clean up spilled fuel immediately.
- Use clean approved non-metal container to prevent static electric discharge.
- Use clean approved plastic funnel without screen or filter to prevent static electric discharge.

IMPORTANT: Avoid damage! Dirt and water in fuel can cause engine damage:

- Clean dirt and debris from the fuel tank opening.
- Use clean, fresh, stabilized fuel.
- Fill the fuel tank at the end of each day's operation to keep condensation out of the fuel tank.
- Use a non-metallic funnel with a plastic mesh strainer when filling the fuel tank or container.

Fill fuel tank at the end of each day's operation to prevent condensation and freezing during cold weather.

1. Park machine safely. (See Parking Safely in the SAFETY section.)
2. Allow engine to cool.
3. Remove any trash from area around fuel tank cap.
4. Remove fuel tank cap slowly to allow any pressure built up in tank to escape.
5. Fill fuel tank only to bottom of filler neck.
6. Install fuel tank cap.

Raising and Lowering Hood

Raising

1. Park machine safely. (See Parking Safely in the SAFETY section.)

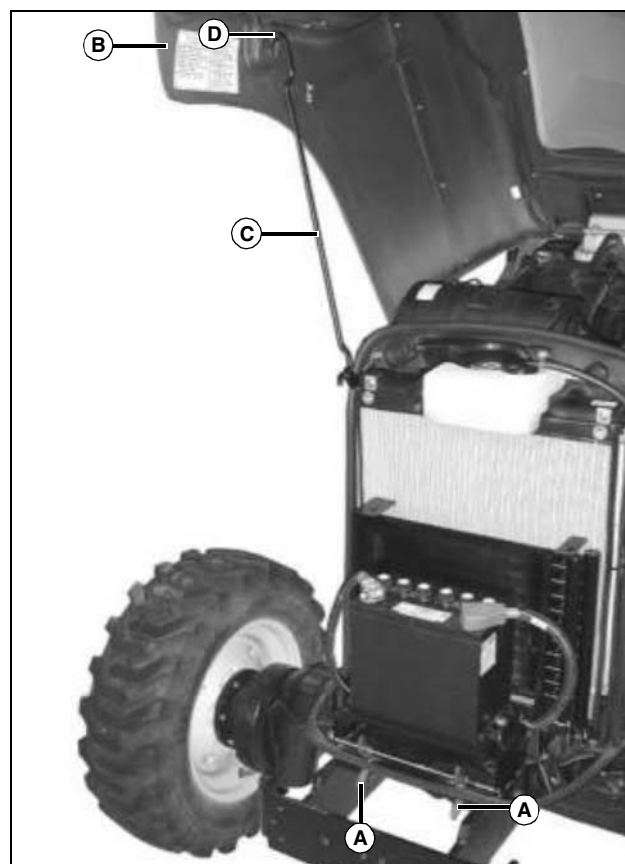

MX20948

2. Lift either hood release lever (A).
3. Raise hood (B), and raise support rod (C) to secure into bracket hole (D).

Lowering

1. Lift hood slightly to remove weight from support rod (C).
2. Release support rod from bracket hole (D), and lower support rod to latch on machine frame.
3. Slowly lower hood.
4. Push down on front of hood to lock the latch.

Servicing Air Conditioner

Air Conditioner Checks

Check the following if air conditioner will not cool, or if cooling is intermittent:

CAUTION: Avoid injury! Refrigerant under pressure. Improper servicing may cause refrigerant to penetrate eyes and skin or cause burns.

SERVICE MISCELLANEOUS

IMPORTANT: Avoid damage! R134a refrigerant must be used. This requires special equipment and procedures. See your John Deere dealer.

NOTE: Some oil seepage from compressor shaft seal, on the lower front, is normal.

1. If air conditioner clutch slips after tractor has been in storage, compressor may be stuck.

- Stop engine and turn ignition switch to stop (off) position.
- Raise hood and rotate clutch hub back and forth to free compressor.

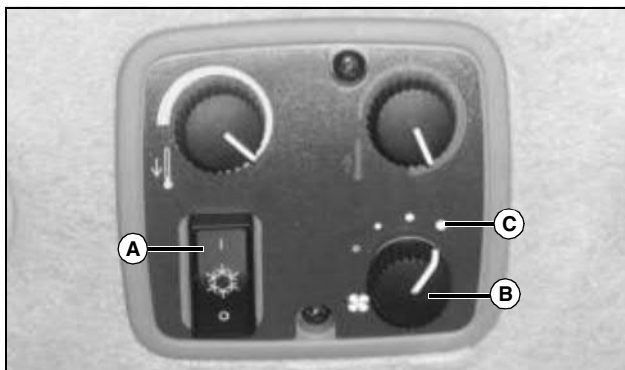

MX22964

2. Run engine at 2000 rpm. Push top half of A/C and defrost switch (A) and set blower control knob (B) to high position (C). If cooling is intermittent, clean hood grille, radiator and condenser. If problem is not solved, see your John Deere dealer.

3. Inspect operator enclosure (cab) filter for restriction. If problem persists, see your John Deere dealer to have evaporator core cleaned.

Cleaning Air Conditioner Condenser



CAUTION: Avoid injury! Compressed air can cause debris to fly a long distance.

- Clear work area of bystanders.
- Wear eye protection when using compressed air for cleaning purposes.
- Reduce compressed air pressure to 210 kPa (30 psi).

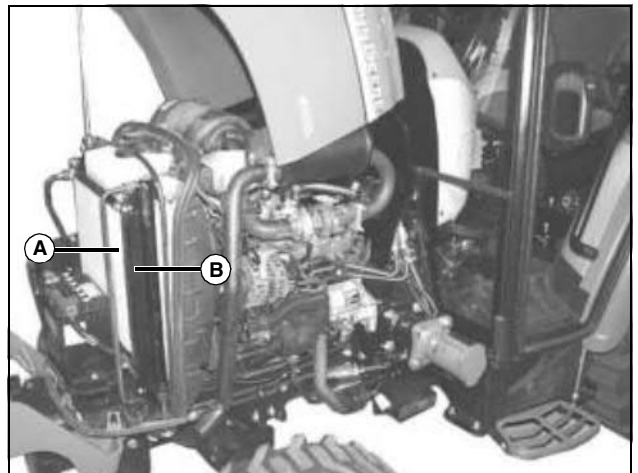

MX35851

1. Raise hood, remove screen (A), and check air conditioner condenser (B) for dirt and debris. Clean condenser using a brush or compressed air.

2. If a more thorough cleaning is necessary, clean radiator from behind with compressed air or water. Straighten any bent fins.

Cleaning Cab Air Filter

IMPORTANT: Avoid damage! Remove any rear implement before servicing cab air filter. Do not stand on 3-point hitch, drawbar hitch or PTO shield.

SERVICE MISCELLANEOUS

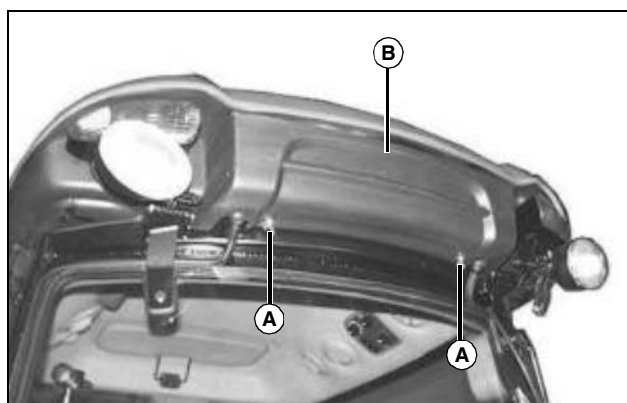

1. Remove two wing bolts (A), washers, and filter base (B).

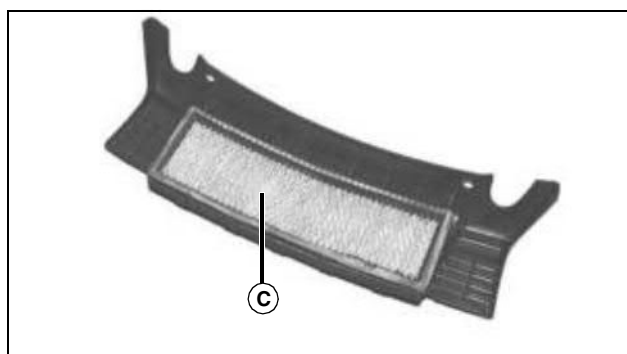

2. Remove filter (C) from filter base, and clean with compressed air. Inspect filter for damage. Replace if necessary.

3. Install filter back into filter base.

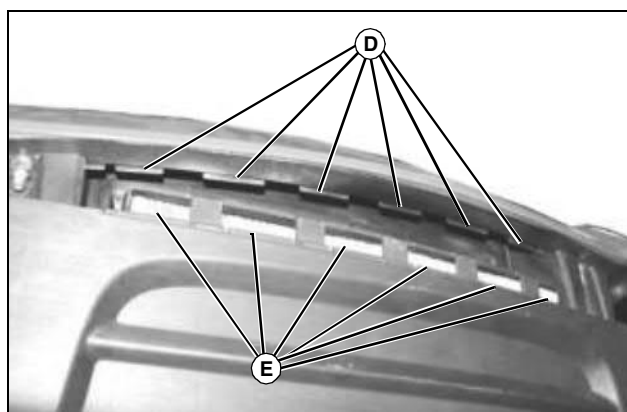

4. Install filter base, making sure six tabs (D) on roof panel are installed into slots (E) in filter base. Secure base assembly back into roof panel with two washers and wing bolts.

Checking Cab Rollover Protection System Installation



CAUTION: Avoid injury! To maintain operator protection and ROPS certification:

- Do not repair or revise the ROPS.
- Any alteration of the ROPS must be approved by the manufacturer.

IMPORTANT: Avoid damage! Make certain all parts are installed correctly. If cab protection system is loosened or removed for any reason, tighten mounting capscrews to specification.

The protection offered by cab protection system will be impaired if cab protection system is subjected to structural damage, as in an overturn incident, or is in any way altered by welding, bending, drilling, or cutting. A damaged cab protection system should be replaced, not reused. Any alteration to the cab protection system must be approved by the manufacturer.

1. When installation of equipment on a machine necessitates loosening or removing cab protection system, mounting capscrews should be tightened to specification.
2. Inspect cab protection system mounting hardware every 50 hours for proper torque or replacement.



3. Lift up rubber floor mat (A) to access FRONT mounting hardware.

SERVICE MISCELLANEOUS



MX35533

4. Remove fastener and pull insulation liner away from fender to access REAR mounting hardware (B).
5. Tuck the insulation liner under the fender panels when complete.
6. Tighten the mounting hardware to 260 N•m (192 lb-ft).

Checking Wheel Bolts and Hardware

CAUTION: Avoid injury! Check rim, hub, and axle hardware periodically to prevent possible machine roll-over.

When machine is new or anytime wheel hardware is loosened, tighten all bolts after one hour of operation and every four hours thereafter until proper torque values are maintained.

Tightness of wheel hardware must be maintained according to service interval recommendations. Check wheel bolt tightness as follows:

Front Wheel Bolts

Tighten front wheel bolts alternately to 140 N•m (103 lb-ft).

Rear Wheel Bolts

Tighten rear wheel bolts alternately to 140 N•m (103 lb-ft).

Removing and Installing Wheels

CAUTION: Avoid injury! Remove wheels safely.

- Use a safe lifting device and support machine securely on jack stands.
- Block front and rear of wheel not raised to prevent machine movement.
- Wheel can be heavy or difficult to handle when removing.

Front Wheel Removal

1. Loosen lug nuts slightly before raising front axle.
2. Raise front of machine and lower onto support stands so that machine is supported by front axle.
3. Remove lug bolts and wheel.

NOTE: If the front wheels are being removed to perform work on the front axles, lower machine onto suitable stands that will support the machine by the frame.

Front Wheel Installation

1. Install wheels onto axle, insert lug bolts and lightly tighten bolts.
2. Raise front of machine, remove support stands and lower machine to floor.
3. Tighten lug bolts to 140 N•m (103 lb-ft).

Rear Wheel Removal

1. Loosen lug bolts slightly before raising machine rear axle.
2. Raise rear of machine and lower onto support stands so that machine is supported by rear axle.
3. Remove lug bolts and wheel.

Rear Wheel Installation:

1. Install wheels onto axle, insert lug bolts and lightly tighten bolts.
2. Raise rear of machine, remove support stands and lower machine to floor.
3. Tighten lug bolts to 140 N•m (103 lb-ft).

SERVICE MISCELLANEOUS

Checking Tire Pressure



CAUTION: Avoid injury! Explosive separation of tire and rim parts is possible when they are serviced incorrectly:

- Do not attempt to mount a tire without the proper equipment and experience to perform the job.
- Do not inflate the tires above the recommended pressure.
- Do not weld or heat a wheel and tire assembly. Heat can cause an increase in air pressure resulting in an explosion. Welding can structurally weaken or deform the wheel.
- Do not stand in front or over the tire assembly when inflating. Use a clip-on chuck and extension hose long enough to allow you to stand to one side.

1. Check tires for damage.
2. See tire pressures in SPECIFICATIONS.
3. Check tire pressure with an accurate gauge.
4. Add or remove air, if necessary

Selecting Front Tire Rolling Direction



CAUTION: Avoid injury! Remove wheels safely.

- Use a safe lifting device and support machine securely on jack stands.
- Block front and rear of wheel not raised to prevent machine movement.
- Wheel can be heavy or difficult to handle when removing.

Machines equipped with directional type tires (such as bar tires) have directional arrows located on the tire sidewall. Under most conditions, tires should be installed with the directional arrow pointing in the direction of travel.

If machine is mainly used for loader operations, lug direction may be reversed to increase tire life and improve traction while backing out of dirt piles.

Move wheel from one side of machine to the other to change tire rolling direction.

Changing Wheel Spacing and Tread Width

The front and rear wheels can be mounted in wide or narrow positions to increase or decrease wheel spacing. To provide best stability, operate machine with rear wheels mounted in the wide tread position whenever possible.



CAUTION: Avoid injury! Remove wheels safely.

- Use a safe lifting device and support machine securely on jack stands.
- Block front and rear of wheel not raised to prevent machine movement.
- Wheel can be heavy or difficult to handle when removing.

IMPORTANT: Avoid damage! Always make sure tires rotate in proper direction. Arrows on sidewall should point in direction of forward rotation.

Front Wheel Positions:

- Wide position - Install wheel with valve stem to the inside.
- Narrow position - Install wheel with valve stem to the outside.

Rear Wheel Positions:

- Wide position - Install wheel with valve stem to the inside.
- Narrow position - Install wheel with valve stem to the outside.

For 8 position wheels, the mounting flanges on the rear rims are closer to one edge of the rim than the other, allowing the inner wheels to be mounted in different positions. By changing this position of the wheel on the rim, up to eight different tread widths can be achieved on some machines.

Various positions cannot be used because the tires would strike the fenders. Certain other positions may result in equal tread widths.

Tread width is measured from centerline-to-centerline of each tire.

Mounting Guidelines

- To keep tire rotation in the proper direction when wheels are reversed without removing tires from rims, move each wheel to the opposite side of the machine.
- Rims can be attached to either side of wheel.
- Mounting flanges on rim are closer to one edge of rim.
- Tread width can be changed by turning the wider side in or out.
- To keep tire rotation in the proper direction, move each rim

SERVICE MISCELLANEOUS

to opposite side of machine, rather than turning the rims around.

- Dished wheels can be reversed.
- Tighten all bolts to specifications.

Rear Tire Tread Width Dimensions

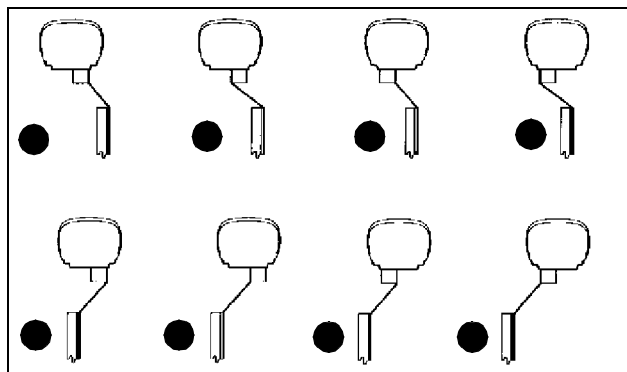

	Rear Tire Size	
Position	22.5LL-16.1 6PR GOLF GA	44x18.00-20 4PR R3 TI
1 (Narrow)	1.5 m (59 in.)	1.4 m (55 in.)*
2	1.6 m (64 in.)	1.7 m (67 in.)
3	N/A	N/A
4	N/A	N/A
5	N/A	N/A
6	N/A	N/A
7	N/A	N/A
8 (Wide)	N/A	N/A

	Rear Tire Size	
Position	17.5L-24 8PR R4 TI	13.6-28 4PR R1 TI
1 (Narrow)	N/A	N/A
2	1.3 m (51 in.)	1.3 m (51 in.)*
3	1.4 m (55 in.)	1.4 m (55 in.)
4	1.5 m (59 in.)	1.5 m (59 in.)
5	1.6 m (63 in.)	1.6 m (63 in.)
6	1.7 m (67 in.)	1.7 m (67 in.)
7	1.8 m (71 in.)	1.8 m (71 in.)
8 (Wide)	1.9 m (75 in.)	1.9 m (75 in.)

Front Tire Tread Width Dimensions

	Front Tire Size	
Position	27x12LL-15 6PR GOLF GA	27x10.5-15 4PR R3
(Narrow)	1.4 m (53 in.)	1.4 m (53 in.)
(Wide)	1.5 m (58 in.)	1.4 m (57 in.)

	Front Tire Size	
Position	10.00-16.5 6PR R4 TI	8.00-16 6PR R1 TI
(Narrow)	1.4 m (53 in.)	1.4 m (54 in.)
(Wide)	1.4 m (57 in.)	1.4 m (55 in.)

* Do not install tires with chains in this position.

NOTE: Do not install tire chains on 13.6-28 R1 tires installed on tractor models 4120-4720 with a cab.

Cleaning Plastic Surfaces

IMPORTANT: Avoid damage! Improper care of machine plastic surfaces can damage that surface:

- Do not wipe plastic surfaces when they are dry. Dry wiping will result in minor surface scratches.
- Use a soft, clean cloth (bath towel, diaper, automotive mitt).
- Do not use abrasive materials, such as polishing compounds, on plastic surfaces.

1. Rinse hood and entire machine with clean water to remove dirt and dust that may scratch the surface.
2. Wash surface with clean water and a mild liquid automotive washing soap.
3. Dry thoroughly to avoid water spots.
4. Wax the surface with a liquid automotive wax. Use products that specifically say "contains no abrasives."

IMPORTANT: Avoid damage! Do not use a power buffer to remove wax.

5. Buff applied wax by hand using a clean, soft cloth.

Cleaning and Repairing Metal Surfaces

Cleaning:

Follow automotive practices to care for your vehicle painted

SERVICE MISCELLANEOUS

metal surfaces. Use a high-quality automotive wax regularly to maintain the factory look of your vehicle's painted surfaces.

Repairing Minor Scratches (surface scratch):

1. Clean area to be repaired thoroughly.

IMPORTANT: Avoid damage! Do not use rubbing compound on painted surfaces.

2. Use automotive polishing compound to remove surface scratches.
3. Apply wax to entire surface.

Repairing Deep Scratches (bare metal or primer showing):

1. Clean area to be repaired with rubbing alcohol or mineral spirits.
2. Use paint stick with factory-matched colors available from your authorized dealer to fill scratches. Follow directions included on paint stick for use and for drying.
3. Smooth out surface using an automotive polishing compound. Do not use power buffer.
4. Apply wax to surface.

TROUBLESHOOTING

Using Troubleshooting Chart

If you are experiencing a problem that is not listed in this chart, see your John Deere distributor for service.

When you have checked all the possible causes listed and you are still experiencing the problem, see your John Deere distributor.

Engine

If	Check
Engine Will Not Crank	PowrReverser: Transmission gear shift lever not in neutral position. PTO engaged. Battery low on charge. Blown fuse. Electrical problem.
Engine Will Not Start	Wrong engine oil viscosity. Engine hand throttle lever not pushed forward. Cold start system not being used, or malfunctioning. Stale fuel / improper fuel / fuel level. Plugged fuel filter. Dirty or faulty fuel injectors. Failed fuel solenoid.
Engine Runs Rough Or Stalls	Engine hand throttle lever not pushed forward. Plugged fuel filter. Plugged air intake system. Fuel cap vent dirty. Faulty seat switch. Stale or improper fuel / fuel level / water in fuel. Dirty or faulty fuel injectors. Low coolant temperature. See your John Deere Dealer. Fuel pump not functioning properly. See your John Deere Dealer.
Engine Knocks	Engine oil level low. Low coolant temperature. See your John Deere Dealer. Engine overheating. Idle speed too slow. Faulty cold advance device.

TROUBLESHOOTING

If	Check
Engine Overheats	<p>Low coolant level.</p> <p>Cooling system needs flushing.</p> <p>Defective radiator cap.</p> <p>Defective thermostat.</p> <p>Defective water temperature indicator or sender.</p> <p>Low oil level.</p> <p>Loose or defective alternator belt.</p> <p>Do not operate at slow idle, operate at fast idle.</p> <p>Dirty grille, radiator screen, or radiator cooling fins.</p> <p>Operating at too fast ground speed for conditions.</p>
Engine Lacks Power	<p>Brakes dragging.</p> <p>Misadjusted rockshaft feedback linkage.</p> <p>Improper type of fuel.</p> <p>Plugged air intake system.</p> <p>Plugged fuel filter.</p> <p>Engine overheating. Operating at too fast ground speed for conditions.</p> <p>Engine oil viscosity too high.</p> <p>Low coolant temperature. See your John Deere Dealer.</p> <p>Dirty or faulty fuel injectors. See your John Deere Dealer.</p> <p>Dirty intercooler fins.</p> <p>Implement improperly adjusted. See implement operator's manual.</p> <p>Improper ballast - adjust load.</p> <p>Rockshaft stop valve closed.</p> <p>Turbo housing hose leaks.</p>
Low Oil Pressure	<p>Engine oil level low.</p> <p>Plugged oil filter.</p> <p>Improper type of oil.</p> <p>Faulty pressure regulating valve.</p>
Engine Uses Too Much Oil	<p>Find and correct oil leaks.</p> <p>Incorrect engine oil.</p> <p>Plugged air intake filter.</p>
Engine Emits White Smoke	<p>Improper type of fuel.</p> <p>Low engine temperature.</p> <p>Defective thermostat. See your John Deere Dealer.</p> <p>Faulty cold advance device.</p>

TROUBLESHOOTING

If	Check
Engine Emits Black Or Gray Exhaust Smoke	<p>Improper type of fuel.</p> <p>Plugged air intake system.</p> <p>Operating at too fast ground speed for conditions.</p> <p>Dirty or faulty fuel injectors. See your John Deere Dealer.</p> <p>Dirty intercooler fins.</p>
High Fuel Consumption	<p>Improper type of fuel.</p> <p>Plugged air intake system.</p> <p>Operating at too fast ground speed for conditions.</p> <p>Dirty or faulty fuel injectors. See your John Deere Dealer.</p> <p>Implement improperly adjusted, causing drag on machine. See implement operator's manual.</p> <p>Plugged crankcase vent tube or baffle.</p> <p>Brakes dragging.</p>

Electrical System

If	Check
Battery Will Not Charge	<p>Loose or corroded connections.</p> <p>Defective battery.</p> <p>Dead cell in battery.</p> <p>Loose or defective alternator belt.</p> <p>Defective alternator.</p> <p>Check 3 pin connector on alternator is plugged in properly.</p>
Battery Discharge Indicator Stays On With Engine Running	<p>Low engine speed.</p> <p>Defective battery.</p> <p>Defective alternator.</p> <p>Loose or defective alternator belt.</p> <p>Check 3 pin connector on alternator is plugged in properly.</p>
Starter Will Not Work	<p>Loose or corroded battery connections.</p> <p>Blown fuse.</p> <p>Starter solenoid connector pulled off or corroded.</p> <p>Low battery power.</p> <p>Neutral start switch faulty. See your John Deere Dealer.</p> <p>Key switch or starter faulty. See your John Deere Dealer.</p> <p>PowrReverser: Transmission gear shift lever not in proper position.</p> <p>PTO engaged or faulty switch.</p> <p>Neutral start switch jumper defective (eHydro only).</p>

TROUBLESHOOTING

If	Check
Starter Turns Slowly	Low battery power - charge battery. Engine oil viscosity too heavy. Loose or corroded battery connections.
Light Circuit Not Working	Blown fuse.
Cab Window wiper(s) and washer will not run	Blown fuse. Faulty wiring or loose connections. Defective switch(es). See your John Deere dealer. Defective motor(s). See your John Deere dealer.
Cab Work lights do not work	Blown fuse. Faulty wiring or loose connections. Defective bulb or switch. Replace bulb or see your John Deere dealer.
Cab Dome light does not work	Blown fuse. Faulty wiring or loose connections. Defective bulb or switch. Replace bulb or see your John Deere dealer. Defective door switch(es). See your John Deere dealer.
Cab Radio does not work	Blown fuse.

Heater and Air Conditioning System

If	Check
All cab electrical switches do not work	Loose, defective or blown fusible link. See your John Deere dealer.
Blower malfunctioning	Blown fuses. Blower does not work. See your John Deere dealer.
Blower operates only in high position	One of two fuses blown. Blown blower resistance assembly. See your John Deere dealer.
Heater does not work	Low coolant level. Check coolant level; add if necessary. Faulty thermostat. See your John Deere dealer. Heater control valve not functioning properly. See your John Deere dealer. Heater core or hoses clogged or damaged. Flush cooling system. See your John Deere dealer. Replace heater core or hoses. See your John Deere dealer.

TROUBLESHOOTING

If	Check
Air conditioning does not work	Blown fuse. Faulty wiring or loose connections. Fan belt loose or slipping. Defective switch. See your John Deere dealer. Defective compressor clutch. See your John Deere dealer.
Drafts	Poor air distribution. Adjust directional air louvers. Set blower switch to medium or low positions.
Inadequate air flow	Clogged air filters. Evaporator core air flow restricted. Faulty blower fan motors. See your John Deere dealer. Defective blower switch. See your John Deere dealer. Faulty wiring or loose connections.
Water leaking or dripping from evaporator core compartment	Loose hose clamp. Evaporator condenser pan dirty. A/C drain tubes plugged.
Strange odors inside operator's cab	Dirty air filters. Evaporator condenser pan dirty. A/C drain tubes plugged. Tobacco smoke and tar on evaporator exterior.
Partial frosting and sweating of lines combined with poor cooling	Fan belt slipping. Loss of refrigerant. See your John Deere dealer. Restricted or clogged liquid line. See your John Deere dealer. Expansion valve malfunctioning. See your John Deere dealer.
Ice flecks blowing from evaporator	Control dial set too low. Adjust temperature control to a warmer position.

TROUBLESHOOTING

If	Check
Failure to cool	<p>Insufficient blower speed.</p> <p>Dirty air filters.</p> <p>Debris on front grille.</p> <p>Lint or dirt on condenser fins.</p> <p>Refrigerant is lost or extremely low. See your John Deere dealer.</p> <p>Loose fan belt.</p> <p>Compressor clutch not engaging. See your John Deere dealer.</p> <p>Expansion valve not functioning. See your John Deere dealer.</p> <p>Restriction in refrigerant system. See your John Deere dealer.</p> <p>Faulty wiring or loose connections.</p> <p>Defective temperature control switch. See your John Deere dealer.</p> <p>Outside temperature too low, below 21°C (70°F). Wait until day gets warmer. If there is a malfunction in system, see your John Deere dealer.</p> <p>Condenser is overheating. Clean condenser screens, cores and fins of condenser and radiator.</p> <p>Severe restriction in high side. See your John Deere dealer.</p> <p>Burned out clutch field or faulty field. See your John Deere dealer.</p> <p>Short circuit in control circuit or failure of a switch in circuit. See your John Deere dealer.</p>
Hissing noise at expansion valve	<p>Loss of refrigerant. See your John Deere dealer.</p> <p>Restriction in refrigerant system.</p> <p>Check receiver-dryer for uniformity of temperature. See your John Deere dealer.</p>

Machine

If	Check
Operation Sluggish, Slow	Suction side filter may need replacement.
Poor Hydraulic Performance	<p>Suction side filter may need replacement.</p> <p>Water in oil.</p>
Excessive Machine Vibration	<p>Engine speed too slow.</p> <p>Throttle linkage out of adjustment.</p>

TROUBLESHOOTING

If	Check
Machine Will Not Move With Engine Running	Electrical problems. Operator pushing down both travel pedals at same time. Park brake locked. Transmission oil level low. Transmission oil cold - allow engine to warm. Transmission range shift lever in neutral position. Suction side filter may need replacement. Operator not in seat.
3-point Hitch Fails To Lift	Low oil level. Worn hydraulic pump. Rate of drop valve closed. Excessive load on hitch. Hydraulic oil too cold. Hydraulic oil suction filter plugged.
3-point Hitch Lifts Slowly	Suction side filter may need replacement. Worn hydraulic pump.
3-point Hitch Drops Slowly Or Does Not Drop	Rate-of-drop valve closed. Rate-of-drop valve set too slowly.
3-point Hitch Drops Too Fast	Rate-of-drop set too fast. Load too heavy.

Brakes

If	Check
Rear Wheel Brakes Not Working	Brakes out of adjustment. Worn or damaged brake linkage. See your John Deere Dealer.

Steering

If	Check
Steering Not Working	Hydraulic suction filter plugged. Improper tire inflation. Steering linkage needs lubrication. Excessive play in steering. See your John Deere Dealer.

TROUBLESHOOTING

Error Codes

The following is not a complete list of errors which may display on your machine instrument panel. Contact your John Deere dealer when any other errors are displayed.

VALUE	DESCRIPTION	PROBLEM SOURCE	MACHINE RESPONSE	ACTION
Err 01	Forward and reverse pedals.	Both pedals are depressed.	Machine does not drive.	Release both pedals and depress one at a time. Contact your John Deere dealer.
Err 02	Forward Pedal.	Voltage signal out-of-range or not calibrated.	Machine does not drive.	Contact your John Deere dealer.
Err 03	Reverse Pedal.	Voltage signal out-of-range or not calibrated.	Machine does not drive.	Contact your John Deere dealer.
Err 04	Engine Speed.	No signal at Engine Speed input.	No anti-stall or cruise functions; Loss of performance.	Contact your John Deere dealer.
Err 05	Brake and Cruise Set/Decel Switch.	Cruise control Set/Decel switch depressed while brake is engaged.	No cruise function.	Release brake pedal; Contact your John Deere dealer.
Err 06	MFWD Speed.	No signal at MFWD speed input.	No cruise function; Loss of performance.	Contact your John Deere dealer.
Err 07	Cruise Set/Decel Switch.	Cruise Set/Decel switch is held or stuck on.	No cruise function.	Contact your John Deere dealer.
Err 08	Throttle Sensor.	Voltage signal out-of-range or not calibrated.	No anti-stall function; Loss of performance.	Contact your John Deere dealer.
Err 09	Cruise On/Off and Set Max Speed switches.	Cruise and Max Speed inputs are both active.	No cruise function.	Contact your John Deere dealer.
Err 11	Cruise Set/Decel and Cruise Res/Accel switches.	Set/Decel and Resume/Accel switches are both active.	No cruise function.	Contact your John Deere dealer.
Err 12	Sensor Supply voltage.	Voltage is out-of-range.	Machine does not drive.	Contact your John Deere dealer.
Err 14	Pump Current.	Coil resistance too high (open) or too low (short).	Machine does not drive.	Contact your John Deere dealer.
Err 15	Operator Present.	Operator not in the seat.	Machine does not drive.	Return back to the seat; Contact your John Deere dealer.

TROUBLESHOOTING

VALUE	DESCRIPTION	PROBLEM SOURCE	MACHINE RESPONSE	ACTION
Err 57	HST Timeout.	No response from HST controller.	Loss of features.	Contact your John Deere dealer.
Err 60	Right Red Lamp ON.	Output from the Display is short circuit.	No right turn signal on the ROPS.	Check the right red lamp; Contact your John Deere dealer.
Err 61	Right Red Lamp OFF.	Output from the Display is open.	No right turn signal on the ROPS.	Check the right red lamp; Contact your John Deere dealer.
Err 62	Left Red Lamp ON.	Output from the Display is short circuit.	No left turn signal on the ROPS.	Check the left red lamp; Contact your John Deere dealer.
Err 63	Left Red Lamp OFF.	Output from the Display is open.	No left turn signal on the ROPS.	Check the left red lamp; Contact your John Deere dealer.
Err 64	Right Amber Lamp ON.	Output from the Display is short circuit.	No right hazard signal on the ROPS.	Check the right amber lamp; Contact your John Deere dealer.
Err 65	Right Amber Lamp OFF.	Output from the Display is open.	No right hazard signal on the ROPS.	Check the right amber lamp; Contact your John Deere dealer.
Err 66	Left Amber Lamp ON.	Output from the Display is short circuit.	No left hazard signal on the ROPS.	Check the left amber lamp; Contact your John Deere dealer.
Err 67	Left Amber Lamp OFF.	Output from the Display is open.	No left hazard signal on the ROPS.	Check the left amber lamp; Contact your John Deere dealer.
Err 68	Hold-in Relay ON.	Output from the Display is short circuit.	No fuel to the engine.	Contact your John Deere dealer.
Err 69	Hold-in Relay OFF.	Output from the Display is open.	No fuel to the engine.	Contact your John Deere dealer.
Err 70	Starter Relay ON.	Output from the Display is short circuit.	Can not crank the engine.	Contact your John Deere dealer.
Err 71	Starter Relay OFF.	Output from the Display is open.	Can not crank the engine.	Contact your John Deere dealer.
Err 72	Display Mode Switch.	The LCD Display Mode/Configuration input is stuck on.	No acknowledgement of errors; No other info selectable; No HST commands selectable.	Contact your John Deere dealer.

STORAGE

Storing Safety



CAUTION: Avoid injury! Fuel vapors are explosive and flammable. Engine exhaust fumes contain carbon monoxide and can cause serious illness or death:

- **Run the engine only long enough to move the machine to or from storage.**
- **Do not store vehicle with fuel in the tank inside a building where fumes may reach an open flame or spark.**
- **Allow the engine to cool before storing the machine in any enclosure.**

IMPORTANT: Avoid damage! Stale fuel can produce varnish and plug carburetor or injector components and affect engine performance.

- **Add fuel conditioner or stabilizer to fresh fuel before filling tank.**

4. Mix fresh fuel and fuel stabilizer in separate container. Follow stabilizer instructions for mixing.
5. Fill fuel tank with stabilized fuel.
6. Run engine for a few minutes to allow fuel mixture to circulate through fuel system.

Engine:

Engine storage procedure should be used when vehicle is not to be used for longer than 60 days.

1. Change engine oil and filter while engine is warm.
2. Service air filter if necessary.
3. Clean debris from engine air intake screen.
4. Clean the engine and engine compartment.
5. Remove battery.
6. Clean the battery and battery posts. Check the electrolyte level on batteries requiring maintenance.
7. Close fuel shut-off valve, if your machine is equipped.
8. Store the battery in a cool, dry place where it will not freeze.

NOTE: The stored battery should be recharged every 90 days.

9. Charge the battery.
10. Store the vehicle in a dry, protected place. If vehicle is stored outside, put a waterproof cover over it.

Preparing Machine for Storage

1. Repair any worn or damaged parts. Replace parts if necessary. Tighten loose hardware.
2. Repair scratched or chipped metal surfaces to prevent rust.
3. Wash the machine and apply wax to metal and plastic surfaces.
4. Run machine for five minutes to dry belts and pulleys.
5. Apply light coat of engine oil to pivot and wear points to prevent rust.
6. Lubricate grease points.
7. Check tire pressure.

Preparing Fuel and Engine For Storage

Fuel:

If you have been using Stabilized Fuel, add stabilized fuel to tank until the tank is full.

NOTE: Filling the fuel tank reduces the amount of air in the fuel tank and helps reduce deterioration of fuel.

If you are not using Stabilized Fuel:

1. Park machine safely in a well-ventilated area.

NOTE: Try to anticipate the last time the machine will be used for the season so very little fuel is left in the fuel tank.

2. Turn on engine and allow to run until it runs out of fuel.
3. Turn key to OFF position.

Removing Machine From Storage

1. Check tire pressure.
2. Check engine oil level.
3. Check battery electrolyte level. Charge battery if necessary.
4. Install battery.
5. Lubricate all grease points.
6. Open fuel shut-off valve, if your machine is equipped.
7. Run the engine 5 minutes without any attachments running to allow oil to be distributed throughout engine.
8. Be sure all shields and guards or deflectors are in place.

SPECIFICATIONS

Engine

Manufacturer	Yanmar
Model Number (3120)	3TNV84
Model Number (3320)	3TNV88-BMJT
Model Number (3520)	3TNV84T-BMJT
Model Number (3720)	3TNV84HT-BJT
Type	Diesel
Gross Horsepower (3120)	22 kW (29.5 hp)
Gross Horsepower (3320)	24.2 kW (32.4 hp)
Gross Horsepower (3520)	27.7 kW (37.2 hp)
Gross Horsepower (3720)	32.6 kW (43.7 hp)
Manufacturer's Estimated PTO Horsepower (3120 eHydro)	16.4 kW (22 hp)
Manufacturer's Estimated PTO Horsepower (3320 PRT)	19.0 kW (25.5 hp)
Manufacturer's Estimated PTO Horsepower (3320 eHydro)	18.6 kW (25 hp)
Manufacturer's Estimated PTO Horsepower (3520 PRT)	22.7 kW (30.5 hp)
Manufacturer's Estimated PTO Horsepower (3520 eHydro)	22.4 kW (30 hp)
Manufacturer's Estimated PTO Horsepower (3720 eHydro)	26.1 kW (35 hp)
Low Idle Speed	950 rpm
Rated Engine Speed	2600 rpm
High Idle Speed	2775 rpm
Operating Range	1000 - 2810 rpm
Engine Torque @ Rated Speed (3120)	75.4 N•m (55.6 lb-ft)
Maximum Torque @ 1560 rpm (3120)	90.4 N•m (66.7 lb-ft)
Engine Torque @ Rated Speed (3320)	83.5 N•m (61.6 lb-ft)
Maximum Torque @ 1560 rpm (3320)	100.2 N•m (73.9 lb-ft)
Engine Torque @ Rated Speed (3520)	96.4 N•m (71.1 lb-ft)
Maximum Torque @ 1560 rpm (3520)	115.8 N•m (85.4 lb-ft)
Engine Torque @ Rated Speed (3720)	114.3 N•m (84.3 lb-ft)
Maximum Torque @ 1560 rpm (3720)	137.1 N•m (101.1 lb-ft)
Displacement (3120, 3520, and 3720)	1.5 L (91.5 cu in.)
Displacement (3320)	1.64 L (100.1 cu in.)
Cylinders	3
Bore and Stroke (3120, 3520, and 3720)	84 x 90 mm (3.3 x 3.54 in.)
Bore and Stroke (3320)	88 x 90 mm (3.46 x 3.54 in.)
Compression Ratio	18.5:1
Lubrication	Pressurized
Cooling System	Water Pump
Oil Filter	Single Element
Air Cleaner	Dry Type with Safety Element

SPECIFICATIONS

Starting Aid Air Heater

Electrical System

Type 12 Volt
Battery Size 500 Cold Cranking Amps at -18°C (0°F)
Alternator 40 Amp
Starter Size 1.4 kW (1.9 hp)

Fuel System

Fuel Filter Replaceable Element
Fuel Diesel
Fuel Pump In-Line with Electric Shutoff
Fuel Delivery Direct Injection, Self Bleeding

Drive Train

Transmission (3120, 3320 & 3520 PowrReverser Transmission) 12x12 PowrReverser (4WD Only)
Transmission (3120, 3320, 3520 & 3720 eHydro Transmission) eHydro (4WD Only)
Number Of Speeds (3120, 3320 & 3520 PowrReverser Transmission) 12 Forward, 12 Reverse
Number Of Speeds (3120, 3320, 3520 & 3720 eHydro Transmission) Infinite Forward, Infinite Reverse
Mechanical Front Wheel Drive Standard All Models
Capability for MFWD All Ranges
Rear Final Drive Type Spur Gear
Differential Lock Mechanical
Brakes Type Wet Disk
Steering Power, Hydrostatic
Main Clutch Disk Type (3120, 3320 & 3520 PowrReverser Transmission) Multiple Stage Wet
Main Clutch Disk Diameter (PowrReverser Transmissions) 11.3 cm (4.4 in.)
Front Axle Operating Capacity 720-1450 kg (1587-3197 lb)
Rear Axle Operating Capacity 1815 kg (4002 lb)
Drawbar Tongue Capacity 400 kg (882 lb)

Hydraulic System

Type of System Open Center
Power Steering Standard
Implement and Steering Pump Type Dual Tandem Gear Pump
Working Pressure 17237 kPa (2500 psi)
Pump Capacity (Main) @ Rated Speed 32.5 L/min (8.6 gpm)

SPECIFICATIONS

Pump Capacity (Power Steering) @ Rated Speed	20 L/min (5.3 gpm)
Total Flow of Pumps @ Rated Speed	52.5 L/min (13.9 gpm)

3 Point Hitch

Type	Category 1
Lift Capacity (24-in. behind link arms)	999 kg (2200 lb)
Dimension - Lower Link Ball Socket ID	22 mm (7/8 in.)
Dimension - Upper Link Pin Hole ID	19 mm (3/4 in.)
Dimension - Normal Width @ Lower Hitch Pins	68.6 cm (27 in.)
Dimension - Normal Height From Center Pin to Hitch Pin	45.7 cm (18 in.)

Drawbar Load

Maximum Static Vertical Load	255 kg (562 lbs)
------------------------------	------------------

PTO

Type	Independent
Clutch Type	Wet Disk
Brake Type	Wet Disk
Speed (Mid PTO rpm @ Rated Engine Speed)	2100 rpm
Speed (Rear PTO rpm @ Rated Engine Speed)	540 rpm

Fluid Capacities

Fuel Tank (tractor without cab)	51.1 L (13.5 gal)
Fuel Tank (tractor with cab)	44 L (11.8 gal)
Cooling System (tractor without cab)	5.3 L (1.4 gal.)
Cooling System (tractor with cab)	7.0 L (1.8 gal.)
Crankcase w/ Filter (3120, 3320, 3520)	4.8 L (5.1 qt.)
Crankcase w/ Filter (3720)	5.7 L (6.0 qt.)
Transmission and Hydraulic System (PowrReverser Models)	23.8 L (6.3 gal.)
Transmission and Hydraulic System (eHydro Models)	25.7 L (6.8 gal.)
Front Axle	4.5 L (1.2 gal.)
Windshield Washer Fluid Reservoir	2.8 L (0.7 gal.)
Refrigerant (R134a)	1.3 kg (2.8 lb)

SPECIFICATIONS

Ground Speeds (Forward and Reverse @ 2600 Engine RPM)

3320 and 3520 PowrReverser Transmission with 11.2-24 6PR R1 Rear Tires

Range A - Gear 1.....	1.3 km/h (0.83 mph)
Range A - Gear 2.....	1.8 km/h (1.1 mph)
Range A - Gear 3.....	2.3 km/h (1.4 mph)
Range A - Gear 4.....	3 km/h (1.9 mph)
Range B - Gear 1.....	3.9 km/h (2.4 mph)
Range B - Gear 2.....	5.1 km/h (3.2 mph)
Range B - Gear 3.....	6.6 km/h (4.1 mph)
Range B - Gear 4.....	8.8 km/h (5.5 mph)
Range C - Gear 1.....	11.6 km/h (7.2 mph)
Range C - Gear 2.....	15.3 km/h (9.5 mph)
Range C - Gear 3.....	19.6 km/h (12 mph)
Range A - Gear 4.....	26.4 km/h (16.4 mph)

3120, 3320, 3520 and 3720 eHydro Transmission with 11.2-24 6PR R1 Rear Tires

Range A.....	6.8 km/h (4.2 mph)
Range B.....	13.4 km/h (8.3 mph)
Range C.....	30.6 km/h (19 mph)

3120, 3320, 3520 and 3720 eHydro Transmission with 41x14.00-20 4PR R3 Rear Tires

Range A.....	6.4 km/h (4 mph)
Range B.....	12.6 km/h (7.8 mph)
Range C.....	28.9 km/h (18 mph)

3120, 3320, 3520 and 3720 eHydro Transmission with 43x16.00-20 4PR R4 Rear Tires

Range A.....	6.5 km/h (4 mph)
Range B.....	12.8 km/h (8 mph)
Range C.....	29.3 km/h (18.2 mph)

3120, 3320, 3520 and 3720 eHydro Transmission with 15.00-19.5 6PR R4 Rear Tires

Range A.....	6.2 km/h (3.8 mph)
Range B.....	12.1 km/h (7.5 mph)
Range C.....	27.8 km/h (17.3 mph)

3120, 3320, 3520 and 3720 eHydro Transmission with 41LLx18-16.1 6PR Golf Rear Tires

Range A.....	6.2 km/h (3.8 mph)
Range B.....	12.2 km/h (7.6 mph)
Range C.....	28 km/h (17.4 mph)

SPECIFICATIONS

Front Tires

Available All Models

.....	7.00-14 6PR R1 GA
.....	27x8.50-15 6PR R3 GA
.....	27x8.50-15 6PR R4 GA
.....	25x8.50-14 6PR R4 GA
.....	25/10.50LL-15 6PR GOLF GA

Front Tire Inflation Pressures

NOTE: Minimum / Maximum pressures given. Minimum pressure is for unloaded, unballasted tractor.

7.00-14 6PR R1 GA	83 kPa/250 kPa (12 psi/36 psi)
27x8.50-15 6PR R3 GA	110 kPa/310 kPa (16 psi/45 psi)
27x8.50-15 6PR R4 GA	83 kPa/310 kPa (12 psi/45 psi)
25x8.50-14 6PR R4 GA	83 kPa/340 kPa (12 psi/49 psi)
25/10.50LL-15 6PR GOLF GA	69 kPa/69 kPa (10 psi/10 psi)

Rear Tires

Available All Models

.....	11.2-24 6PR R1 GA
.....	41x14.00-20 4PR R3 GA
.....	43x16.00-20 4PR R4 GA
.....	15.00-19.5 6PR R4 GA
.....	41LLx18-16.1 6PR Golf GA

Rear Tire Inflation Pressures

NOTE: Minimum / Maximum pressures given. Minimum pressure is for unloaded, unballasted tractor.

11.2-24 6PR R1 GA	83 kPa/180 kPa (12 psi/26 psi)
41x14.00-20 4PR R3 GA	69 kPa/170 kPa (10 psi/25 psi)
43x16.00-20 4PR R4 GA	83 kPa/140 kPa (12 psi/20 psi)
15.00-19.5 6PR R4 GA	138 kPa/210 kPa (20 psi/31 psi)
41LLx18-16.1 6PR Golf GA	42 kPa/42 kPa (6 psi/6 psi)

Tire Loads

NOTE: Maximum load capacity for single tire.

Front (7.00-14 6PR R1 GA)	430 kg (948 lb)
Front (27x8.50-15 6PR R3 GA)	750 kg (1654 lb)

SPECIFICATIONS

Front (27x8.50-15 6PR R4 GA).....	750 kg (1654 lb)
Front (25x8.50-14 6PR R4 GA).....	620 kg (1367 lb)
Front (25/10.50LL-15 6PR GOLF GA)	700 kg (1543 lb)
Rear (11.2-24 6PR R1 GA)	990 kg (2183 lb)
Rear (41x14.00-20 4PR R3 GA)	1490 kg (3285 lb)
Rear (43x16.00-20 4PR R4 GA)	1420 kg (3131 lb)
Rear (15.00-19.5 6PR R4 GA).....	1790 kg (3946 lb)
Rear (41LLx18-16.1 6PR Golf GA).....	1990 kg (4387 lb)

Dimensions

NOTE: Height and width dimensions can vary due to dimensional growth of tires.

Wheelbase.....	1.7 m (68 in.)
Overall Length w/ 3-Point Hitch.....	3.1 m (120.2 in.)
Overall Width w/ R1 Tires (Minimum).....	1.3 m (52.4 in.)
Overall Width w/ R1 Tires (Maximum)	1.7 m (68.4 in.)
Overall Width w/ R3 Tires (Minimum).....	1.4 m (53.9 in.)
Overall Width w/ R3 Tires (Maximum)	1.5 m (59.1 in.)
Overall Width w/ 43 x 16.00-20 R4 Tires (Minimum)	1.5 m (58.1 in.)
Overall Width w/ 43 x 16.00-20 R4 Tires (Maximum).....	1.5 m (59.7 in.)
Overall Width w/ 15.00-19.5 R4 Tires (Minimum).....	1.4 m (57.3 in.)
Overall Width w/ 15.00-19.5 R4 Tires (Maximum)	1.5 m (58.9 in.)
Overall Width w/ Golf Tires (Minimum).....	1.5 m (59.5 in.)
Overall Width w/ Golf Tires (Maximum)	1.6 m (64.7 in.)
Inside Width w/ R1 Tires (Minimum).....	1.03 m (40.6 in.)
Inside Width w/ R1 Tires (Maximum)	1.4 m (56.6 in.)
Inside Width w/ R3 Tires (Minimum).....	1.02 m (40.4 in.)
Inside Width w/ R3 Tires (Maximum)	1.2 m (45.6 in.)
Inside Width w/ 43 x 16.00-20 R4 Tires (Minimum)	1.1 m (42 in.)
Inside Width w/ 43 x 16.00-20 R4 Tires (Maximum).....	1.1 m (43.7 in.)
Inside Width w/ Golf Tires (Minimum)	1.02 m (40.3 in.)
Inside Width w/ Golf Tires (Maximum)	1.2 m (45.5 in.)
Inside Width w/ 15.00-19.5 R4 Tires (Minimum).....	1.1 m (42 in.)
Inside Width w/ 15.00-19.5 R4 Tires (Maximum)	1.2 m (43.7 in.)
Height From Ground (Tractor without cab, with standard R1 tires)	
To Top of Hood	1.4 m (57 in.)
To Top of Folding ROPS	2.4 m (93.3 in.)
Height From Ground (Tractor with Cab, R3 tires)	
To Top of Cab	2.3 m (89.4 in.)

SPECIFICATIONS

Weight

All Models (without cab) 1316 kg (2900 lb)

All Models (with cab) 1619 kg (3570 lb)

Recommended Lubricants

Engine Oil John Deere Plus-50 or TORQ-GARD SUPREME (See SERVICE ENGINE for more information.)

Grease John Deere Multi-Purpose SD Polyurea Grease

..... John Deere Multi-Purpose HD Lithium Complex Grease

Transmission Oil..... Low Viscosity HY-GARD (JDM J20D)

Front Axle Oil Low Viscosity HY-GARD (JDM J20D)

Compressor Oil..... PAG Oil - J.D.

(Specifications and design subject to change without notice.)

Torque Values - Metric Hardware

Torque Values (Dry)							Torque Values (Lubricated)						
Size	Class 7		Class 8.8		Class 10.9		Size	Class 7		Class 8.8		Class 10.9	
	N•m	lb-ft	N•m	lb-ft	N•m	lb-ft		N•m	lb-ft	N•m	lb-ft	N•m	lb-ft
M6			11	8.1	17	12.5	M6			9	6.6	13	9.6
M8	29	21	35	26	41	30	M8	23	17	25	18.5	29	21.4
M10	59	44	67	49	80	59	M10	44	33	51	38	61	45
M12	98	72	113	83	132	97	M12	78	58	83	61	103	76
M14	147	108	167	123	201	148	M14	118	87	127	94	152	112
M16	206	152					M16	167	123				
<ul style="list-style-type: none"> • Use 80% of the value when tightening part is aluminum. • Use 60% of the value for 4T bolts and lock nuts. 							<ul style="list-style-type: none"> • Use 80% of the value when tightening part is aluminum. • Use 60% of the value for 4T bolts and lock nuts. 						

Torque Values - Inch Fastener Hardware

Torque Values (Dry)							Torque Values (Lubricated)						
Size	Grade 2 ¹		Grade 5		Grade 8		Size	Grade 2 ²		Grade 5		Grade 8	
	N•m	lb-ft	N•m	lb-ft	N•m	lb-ft		N•m	lb-ft	N•m	lb-ft	N•m	lb-ft
1/4	7.4	5.5	12	9	17	12.5	1/4	6.1	4.5	9.5	7	13.6	10
5/16	15	11	24	18	35	26	5/16	12.2	9	20	15	28	21
3/8	27	20	45	33	62	46	3/8	22	16	35	26	49	36

SPECIFICATIONS

Torque Values (Dry)							Torque Values (Lubricated)						
Size	Grade 2 ¹		Grade 5		Grade 8		Size	Grade 2 ²		Grade 5		Grade 8	
7/16	43	32	70	52	102	75	7/16	35	26	56	41	79	58
1/2	68	50	108	80	156	115	1/2	53	39	85	63	122	90
9/16	95	70	156	115	217	160	9/16	76	56	122	90	176	130
5/8	136	100	217	160	305	225	5/8	106	78	170	125	217	160
3/4	238	175					3/4	190	140				
<ul style="list-style-type: none"> • Use 80% of the value when tightening part is aluminum. • Use 60% of the value for 4T bolts and lock nuts. 							<ul style="list-style-type: none"> • Use 80% of the value when tightening part is aluminum. • Use 60% of the value for 4T bolts and lock nuts. 						

1. Grade 2 applies for hex cap screws (not hex bolts) up to 152mm (6 in.) long.

2. Grade 2 applies for hex cap screws (not hex bolts) up to 152mm (6 in.) long.

WARRANTY

Product Warranty

Product warranty is provided as part of John Deere's support program for customers who operate and maintain their equipment as described in this manual.

Engine related warranties stated in this manual refer only to emissions-related parts and components of your engine. The complete engine warranty, less emission-related parts and components, is provided separately as the Limited Warranty for New John Deere Commercial & Consumer Equipment.

John Deere, Federal And California Emission Control System Warranty (Non-Road Diesel)

Your Warranty Rights and Obligations

The United States Environmental Protection Agency (EPA), the California Air Resources Board (CARB) and John Deere are pleased to explain the emission control system warranty on your 1995 and later non-road diesel equipment engine. In California, 1995 and later non-road diesel equipment engines must be designed, built and equipped to meet the State's stringent anti-smog standards. In other states, 1997 and later model year equipment engines must be designed, built and equipped to meet the U.S. EPA regulations for non-road diesel engines. John Deere must warrant the emission control system on your non-road diesel equipment engine for the periods of time listed below provided there has been no abuse, neglect or improper maintenance of your non-road diesel equipment engine.

Your emission control system may include parts such as the fuel-injection system and the air induction system. Also included may be connectors and other emission related assemblies.

Where a warrantable condition exists, John Deere will repair your non-road diesel equipment engine at no cost to you including diagnosis, parts and labor.

John Deere Emission Control System Warranty Coverage

In California, 1995 and later non-road diesel equipment engine emissions control-related parts are warranted by John Deere for five years or 3000 hours of operation, whichever occurs first. In other states, 1997 and later non-road diesel equipment engine emissions control-related parts are warranted by John Deere for five years or 3000 hours of operation, whichever occurs first. If any emission related part on your engine is defective, the part will be repaired or replaced by John Deere.

Owner's Warranty Responsibilities

As the non-road diesel equipment engine owner, you are responsible for the performance of the required maintenance listed in your owner's manual. John Deere recommends that you retain all receipts covering maintenance on your non-road diesel equipment engine, but John Deere cannot deny warranty solely for lack of receipts or for your failure to ensure all scheduled maintenance is performed.

As the non-road diesel equipment engine owner, you should however be aware that John Deere may deny you warranty coverage if your non-road diesel equipment engine or a part has failed due to abuse, neglect, improper maintenance or unapproved modifications.

You are responsible for presenting your non-road diesel equipment engine to an authorized John Deere Commercial and Consumer Equipment Retailer as soon as a problem exists. The warranty repairs should be completed in a reasonable amount of time, not to exceed 30 days.

If you have any questions regarding your warranty rights and responsibilities, you should contact your John Deere Commercial and Consumer Equipment Retailer, or the John Deere Customer Contact

Center, 1-800-537-8233.

Length of Warranty Coverage

John Deere warrants to the initial owner and each subsequent purchaser that the non-road diesel equipment engine is:

- Designed, built and equipped so as to conform with all applicable regulations adopted by the California Air Resources Board (CARB) for 1995 and later equipment engines, and all applicable regulations of the United States Environmental Protection Agency (EPA) for 1997 and later equipment engines; and
- Free from defects in materials and workmanship which can cause the failure of an emission warranted part for a period of five years or 3000 hours of operation, whichever occurs first, after the engine is delivered to the initial retail purchaser. John Deere is liable for damages to other engine components caused by the failure of a warranted part during the warranty period. If any emission related part on your engine is defective, the part will be repaired or replaced by John Deere.

Warranted Parts

Coverage under this warranty extends only to the parts listed below (the emission control system parts) to the extent these parts were present on the engine purchased.

Fuel Metering System:

- Fuel injection system.

Air Induction System:

- Air Cleaner
- Turbocharger system.
- Intake manifold.

Diesel System:

- Exhaust manifold.

Miscellaneous Items Used in Above Systems:

- Hoses, belts, connectors and assemblies.

Since emission related parts may vary slightly from model to model, certain models may not contain all of these parts and certain models may contain functionally equivalent parts.

Warranty Service and Charges

Warranty service shall be provided during customary business hours at any authorized John Deere Commercial and Consumer Equipment Retailer. Repair or replacement of any warranted part will be performed at no charge to the owner, including diagnostic labor which leads to the determination that a warranted part is defective, if the diagnostic work is performed at an authorized John Deere Commercial and Consumer Equipment Retailer. Any parts replaced under this warranty shall become the property of John Deere.

Maintenance Warranty Coverage

a) Any warranted part which is not scheduled for replacement as required maintenance shall be warranted as to defects for the warranty period. Any such part repaired or replaced under the warranty shall be warranted for the remaining warranty period.

b) Any warranted part which is scheduled only for regular inspection to the effect of "repair or replace as necessary" shall be warranted as to defects for the warranty period. Any such part repaired or replaced under the warranty shall be warranted for the remaining warranty period.

c) Any warranted part which is scheduled for replacement as required

WARRANTY

maintenance shall be warranted as to defects only for the period of time up to the first scheduled replacement for that part. Any such part repaired or replaced under the warranty shall be warranted for the remainder of the period prior to the first scheduled replacement point for that part.

d) Normal maintenance, replacement or repair of emission control devices and systems, which are being done at the customer's expense, may be performed by any repair establishment or individual; however, warranty repairs must be performed by an authorized John Deere Commercial and Consumer Equipment Retailer.

e) Any replacement part that is equivalent in performance and durability may be used in the performance of any non-warranty maintenance or repairs, and shall not reduce the warranty obligations of John Deere.

Consequential Warranty Coverage

Warranty coverage shall extend to the failure of any engine components caused by the failure of any warranted part still under warranty.

Limitations

This Emission Control System Warranty shall NOT cover any of the following:

- a) Repair or replacement required as a result of (i) misuse or neglect, (ii) improper maintenance or unapproved modifications, (iii) repairs improperly performed or replacements improperly installed, (iv) use of replacement parts or accessories not conforming to John Deere specifications which adversely affect performance and/or durability, (v) alterations or modifications not recommended or approved in writing by John Deere.
- b) Replacement parts, other services and adjustments necessary for normal maintenance.
- c) Transportation to and from the John Deere Commercial and Consumer Equipment Retailer, or service calls made by the Retailer.

Limited Liability

a) The liability of John Deere under this Emission Control System Warranty is limited solely to the remedying of defects in materials or workmanship. This warranty does not cover inconvenience or loss of use of the non-road diesel equipment engine or transportation of the engine to or from the John Deere Commercial and Consumer Equipment Retailer. JOHN DEERE SHALL NOT BE LIABLE FOR ANY OTHER EXPENSE, LOSS, OR DAMAGE, WHETHER DIRECT, INCIDENTAL, CONSEQUENTIAL (EXCEPT AS LISTED ABOVE UNDER "COVERAGE") OR EXEMPLARY ARISING IN CONNECTION WITH THE SALE OR USE OF OR INABILITY TO USE THE NON-ROAD DIESEL ENGINE FOR ANY OTHER PURPOSE.

b) NO EXPRESS EMISSION CONTROL SYSTEM WARRANTY IS GIVEN BY JOHN DEERE WITH RESPECT TO THE ENGINE EXCEPT AS SPECIFICALLY SET FORTH IN THIS DOCUMENT. ANY EMISSION CONTROL SYSTEM WARRANTY IMPLIED BY LAW, INCLUDING ANY WARRANTY OF MERCHANTABILITY OR FITNESS FOR A PARTICULAR PURPOSE, IS EXPRESSLY LIMITED TO THE EMISSION CONTROL SYSTEM WARRANTY TERMS SET FORTH IN THIS DOCUMENT.

c) No dealer is authorized to modify this Federal, California and John Deere Emission Control System Warranty.

Tire Warranty

John Deere warranty applies for tires available through the John Deere parts system. For tires not available through the John Deere parts system, the tire manufacturer's warranty applicable to your machine may not apply

outside the U.S. (See your John Deere dealer for specific information.)

Limited Battery Warranty

NOTE: Applicable in North America only. For complete machine warranty, reference a copy of the John Deere warranty statement. Contact your John Deere dealer to obtain a copy.

TO SECURE WARRANTY SERVICE

The purchaser must request warranty service from a John Deere dealer authorized to sell John Deere batteries, and present the battery to the dealer with the top cover plate codes intact.

FREE REPLACEMENT

Any new battery which becomes unserviceable (not merely discharged) due to defects in material or workmanship within 90 days of purchase will be replaced free of charge. Installation costs will be covered by warranty if (1) the unserviceable battery was installed by a John Deere factory or dealer, (2) failure occurs within 90 days of purchase, and (3) the replacement battery is installed by a John Deere dealer.

PRO RATA ADJUSTMENT

Any new battery which becomes unserviceable (not merely discharged) due to defects in material or workmanship more than 90 days after purchase, but before the expiration of the applicable adjustment period, will be replaced upon payment of the battery's current list price less a pro rata credit for unused months of service. The applicable adjustment period is determined from the Warranty Code printed at the top of the battery and chart below. Installation costs are not covered by warranty after 90 days from the date of purchase.

THIS WARRANTY DOES NOT COVER

- A. Breakage of the container, cover, or terminals.
- B. Depreciation or damage caused by lack of reasonable and necessary maintenance or by improper maintenance.
- C. Transportation, mailing, or service call charges for warranty service.

LIMITATION OF IMPLIED WARRANTIES AND PURCHASER'S REMEDIES

To the extent permitted by law, neither John Deere nor any company affiliated with it makes any warranties, representations, or promises as to the quality, performance or freedom from defect of the products covered by this warranty. IMPLIED WARRANTIES OF MERCHANTABILITY AND FITNESS FOR A PARTICULAR PURPOSE, TO THE EXTENT APPLICABLE, SHALL BE LIMITED IN DURATION TO THE APPLICABLE ADJUSTMENT PERIOD SET FORTH HERE. THE PURCHASER'S ONLY REMEDIES IN CONNECTION WITH THE BREACH OR PERFORMANCE OF ANY WARRANTY ON JOHN DEERE BATTERIES ARE THOSE SET FORTH HERE. IN NO EVENT WILL THE DEALER, JOHN DEERE OR ANY COMPANY AFFILIATED WITH JOHN DEERE BE LIABLE FOR INCIDENTAL OR CONSEQUENTIAL DAMAGES. (Note: Some states do not allow limitations on how long an implied warranty lasts or the exclusion or limitation of incidental or consequential damages. So these limitations and exclusions may not apply to you.) This warranty gives you specific legal rights, and you may also have some rights which vary from state to state.

NO DEALER WARRANTY

The selling dealer makes no warranty of its own and the dealer has no authority to make any representation or promise on behalf of John Deere, or to modify the terms or limitations of this warranty in any way.

WARRANTY

PRO RATA MONTHS OF ADJUSTMENT

NOTE: If your battery is not labeled with a warranty code, it is a warranty code B.

Warranty Code	Warranty Period
A	40 Months
B	36 Months
C	24 Months

INDEX

Numerics

- 3 Point Hitch, Lubricating 56
- 3 Point Hitch, Using 39

A

- Accessory Electrical Outlet, Using 46
- Air Conditioner, Servicing 85
- Air Filter Element, Servicing 59
- Air Filter Hose, Checking 60
- Air Restriction Indicator Light, Checking 61
- Air Temperature Controls 19
- Alternator Belt, Servicing the 65
- Axle Oil Level, Checking Front 70
- Axle Oil, Changing Front 70

B

- Ballast Box, Using Optional Rear 48
- Ballasting Machine 46
- Battery and Terminals, Cleaning 77
- Battery, Removing and Installing 76
- Battery, Service Safely 76
- Battery, Using Booster 77
- Belt, Servicing the Alternator 65
- Bio-Diesel Fuel, Using 84
- Blower Speed, Adjusting 23
- Brake Pedals (PowrReverser), Using 29
- Brake Pedals (eHydro), Using 29
- Bulb, Replacing Headlight 78

C

- Cab Air Filter, Cleaning 86
- Center Link, Positioning 39
- Chain, Using Safety 51
- Checklist, Daily Operating 20
- Controls, Air Temperature 19
- Controls, Floor Panel 19
- Controls, PowrReverser 16
- Controls, eHydro No Cab 17
- Controls, eHydro With Cab 18
- Coolant Level, Checking 61
- Coolant, Engine 62
- Cooling System, Service Safely 61
- Cooling System, Servicing 62
- Cruise Control, Automotive, Using 34
- Cruise Control, Standard, Using 34

D

- Diesel Fuel, Using 84
- Differential Lock, Using 35
- Display Mode Switch, Using 26
- Diverter Valve, Using 46
- Dome Light, Using 23
- Draft Links, Adjusting to Float Position 41
- Draft Links, Adjusting to Rigid Position 42

- Draft Links, Using 40
- Drawbar Hitch, Using 38
- Drawbar Length, Adjusting 38
- Drawbar Loads, Maximum 38
- Driving Machine, PowrReverser 32
- Drop/Lock Valve, Using Rate of 40
- Dual Selective Control Valve (SCV) Lock Lever, Using 44
- Dual Selective Control Valve Lever, Using 44
- Dust Unloading Valve, Cleaning Rubber 58

E

- Electrical Outlet, Accessory, Using 46
- Electrolyte Level, Checking Battery 76
- Emergency Stopping (PowrReverser) 32
- Emergency Stopping (eHydro) 32
- Engine Oil Level, Checking 57
- Engine Speeds, Checking 57
- Engine Warranty Maintenance Statement 57
- Engine, Idling the 31
- Engine, Starting a Stalled 31
- Engine, Starting the 30

F

- Filter, Changing Engine Oil and 58
- Filter, Replacing Fuel 67
- Float Position, Adjusting Draft Links to 41
- Floor Panel Controls 19
- Front Axle Thrust Bolt Torque, Adjusting 71
- Front Weight Bracket Extension (Optional) 49
- Front Weights, Using Optional 49
- Front Wheel Drive (MFWD), Using Mechanical 36
- Fuel Filter Sediment Bowl, Cleaning 67
- Fuel Filter, Replacing 67
- Fuel Injection Nozzles 68
- Fuel Injection Pump 68
- Fuel Safety 15
- Fuel Shut Off Valve, Using 28
- Fuel Storage 101
- Fuel Tank, Filling 85
- Fuses, Replacing 81

G

- Grease 56
- Grease Fittings, Lubricating 56
- Grille and Side Screens, Cleaning 68

H

- Headlight Bulb, Replacing 78
- Hitch, Using 3 Point 39
- Hitch, Using Drawbar 38
- Hood, Raising and Lowering 85
- Hose, Air Filter, Checking 60
- Hoses, Checking Radiator 63
- Hydraulic Hoses, Connecting Implement 43
- Hydraulic Suction Oil Filter, Changing 72
- Hydraulic Third Selective Control Valve (SCV), Using 45

INDEX

I	
Implement Codes	47
Implement Hydraulic Hoses, Connecting	43
Implement Side-to-Side Sway, Adjusting	41
Implement, Leveling Front-to-Rear	40
Implement, Leveling Side-to-Side	41
Implement, Raising and Lowering	39
Instrument Panel, Using the	24
K	
Key Switch, Using	24
L	
Leveling Implement Front-to-Rear	40
Leveling Implement Side-to-Side	41
Light Bulbs, Replacing	80
Light Bulbs, Replacing, Tractor With Cab	78
Light Switch, Using	23
Liquid Weight in Tires, Using	48
Literature, Service	53
LoadMatch, Using	35
Lock Lever, Using Dual Selective Control Valve (SCV)	44
M	
Machine Grease Fittings, Lubricating	56
Mechanical Front Wheel Drive (MFWD), Using	36
Metal Surfaces, Repairing and Cleaning	90
MotionMatch, Using (eHydro)	35
N	
Nozzles, Fuel Injection	68
O	
Oil Filter, Changing Transmission	72
Oil Level, Checking Engine	57
Oil Level, Checking Transmission	71
Oil and Filter, Changing Engine	58
Oil, Changing Front Axle	70
Oil, Changing Transmission	72
Oil, Checking Front Axle	70
Oil, Engine	57
Oil, Transmission and Hydraulic	70
P	
PTO, Tractor With Cab, Operator on Seat, Using	36
PTO, Using Rear	38
Park Brake, Using	30
Parking	12
Parts Catalog	53
Parts, Replacement	53
Plastic And Painted Surfaces, Avoid Damage To	20
Plastic Surfaces, Cleaning	90
Power-Take-Off (PTO), Using Safely	36
PowrReverser Transmission, Operating	32
Pump, Fuel Injection	68
R	
Radiator Hoses, Checking	63
Radiator Screen and Fins, Cleaning	68
Rear Ballast Box, Using Optional	48
Rear PTO, Using	38
Rigid Position, Adjusting Draft Links to	42
Rockshaft Control Lever, Using	39
Roll-Over Protective Structure (ROPS), Raising and Lowering	51
S	
Safety Systems, Testing	26
Safety, Tire	14
Screen, Cleaning Radiator	68
Screens, Cleaning Grille and Side	68
Seat Belt, Using	21
Seat, No Cab, Adjusting	20
Seat, Tractor With Cab, Adjusting	21
Selective Control Valve (SCV), Using Hydraulic Third	45
Selective Control Valve Lever, Using	44
Service Literature	53
Spark Arrestor, Using	11
SpeedMatch, Using	34
Steering Wheel, Adjusting Tilt	23
Stopping (PowrReverser), Emergency	32
Stopping (eHydro), Emergency	32
Stopping the Machine	31
Storage, Removing Machine From	101
Storing Safety	101
T	
Technical Manual	53
Temperature Controls, Using	22
Testing Safety Systems	26
Three Point Hitch, Lubricating	56
Three Point Hitch, Using	39
Throttle Controls, Using	30
Tire Capacities	48
Tire Rolling Direction, Selecting Front	89
Towing Loads	50
Traction Assist, Using	35
Transmission Oil Level, Checking	71
Transmission Oil, Changing	72
Transporting Machine	49
Transporting Machine on Trailer	49
Tread Width and Wheel Spacing, Changing	89
Troubleshooting Chart, Using	92
Turn Signal Switch, Using	25
V	
Valve, Cleaning Rubber Dust Unloading	58
W	
Warranty Maintenance Statement, Engine	57
Warranty, Product	110
Water Separator Sediment Bowl, Servicing	66
Weight Bracket Extension (Optional), Front	49
Weight in Tires, Using Liquid	48

INDEX

Weights, Using Optional Front	49
Wheel Bolts and Hardware, Checking	88
Wheel Spacing and Tread Width, Changing	89
Wheel Weights, Using Optional Rear Cast Iron	48
Wheels, Removing and Installing	88
Windows, Using	22
Windshield Wiper and Washer, Using	25

Z

iMatch Quick-Hitch, Using	42
---------------------------------	----

NOTES

NOTES

NOTES

JOHN DEERE QUALITY STATEMENT

John Deere Quality



John Deere equipment is more than just a purchase, it's an investment in quality. That quality goes beyond our equipment to your John Deere dealer's parts and service support. This support is needed to keep you a satisfied customer.

That's why John Deere has initiated a process to handle your questions or problems, should they arise. The following three steps will help guide you through the process.

Step 1

Refer to your operator's manual

- A. It has many illustrations and detailed information on the safe and proper operation of your equipment.
- B. It gives troubleshooting procedures, and specification information.
- C. It gives ordering information for parts catalogs, service and technical manuals.
- D. If your questions are not answered in the operator's manual, then go to Step 2.

Step 2

Contact your dealer

- A. Your John Deere dealer has the responsibility, authority, and ability to answer questions, resolve problems, and fulfill your parts and service needs.
- B. First, discuss your questions or problems with your dealer's trained parts and service staff.
- C. If the parts and service people are unable to resolve your problem, see the dealership manager or owner.
- D. If your questions or problems are not resolved by the dealer, then go to Step 3.

Step 3

Call the John Deere Customer Contact Center

- A. Your John Deere dealer is the most efficient source in addressing any concern, but if you are not able to resolve your problem after checking your operator's manual and contacting your dealer, call the Customer Contact Center.
- B. For prompt, effective service, please have the following ready before you call:
 - The name of the dealer with whom you've been working.
 - Your equipment model number.
 - Number of hours on machine (if applicable).
 - Your 13-digit serial number which you recorded on the inside front cover of this manual.
 - If the problem is with an attachment, your attachment identification number.
- C. Then call 1-800-537-8233 and our advisor will work with your dealer to investigate your concern.

SERVICE RECORD

Record Service Dates

Engine Oil and Filter Change	Transmission Oil and Filter Change	Front Axle Oil Change	Lubricate Machine	Air Cleaner Element Check/Clean	Fuel Filter Change	Coolant Change