

Document Title: Power transmission, description	Function Group: 400	Information Type: Service Information	Date: 2014/6/13
Profile: EXC, EC220D L [GB]			

Power transmission, description

The excavator's power transmission is a generic name of all components that transmit motive force to perform the various functions of the excavator.

The mechanical power from the engine transmitted via the pump coupling is converted to hydraulic power by the main pumps. Hydraulic power from the main pump goes to the travel motors, swing motor and hydraulic cylinders via the main control valve, where it is converted back to mechanical power, that actuates the travel action, swing action and attachments.

The reduction gears of the planetary mechanisms convert the high speed rotation of the hydraulic motor into low speed, high torque rotating force, at the track unit / sprocket for travel, and at the swing unit / ring gear for swing.

The center passage 360° rotating unit allows high pressure hydraulic flow from the main control valve to the track motors. The unit rotates with the superstructure without twisting hoses therefore oil flow is not obstructed by swing.

Document Title: Function description	Function Group:	Information Type: Service Information	Date: 2014/6/13
Profile: EXC, EC220D L [GB]			

Function description

Track gearbox consists of a two stage planetary mechanism that converts the high speed rotation of the hydraulic motor, into low speed, high torque rotating force at the sprocket hub.

See [990 Hydraulic diagram, travel](#).

Gearbox, torque flow

The power transmitted from the hydraulic motor output shaft is transmitted to the 1st stage sun gear → spline of 1st carrier → 2nd sun gear → 2nd planetary gear → ring gear.

At this time, the reduction ratio of reduction gear is as follows :

Reduction ratio

1st reduction ratio

$$i_1 = ((Z_{s1} + Z_r) \cdot (Z_{s2} + Z_r) / (Z_{s1} \cdot Z_{s2})) - 1$$

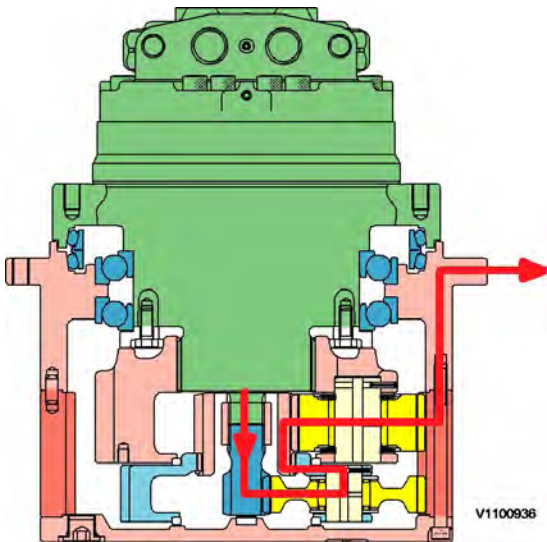

Figure 1

Track gearbox, torque flow

- Z_{s1} = No. of tooth of 1st sun gear
- Z_{s2} = No. of tooth of 2nd sun gear
- Z_r = No. of tooth of ring gear

Document Title: Track gearbox, description	Function Group:	Information Type: Service Information	Date: 2014/6/13
Profile: EXC, EC220D L [GB]			

Track gearbox, description

Track gearbox consists of a two stage planetary mechanism that converts the high speed rotation of the hydraulic motor, into low speed, high torque rotating force at the sprocket hub.

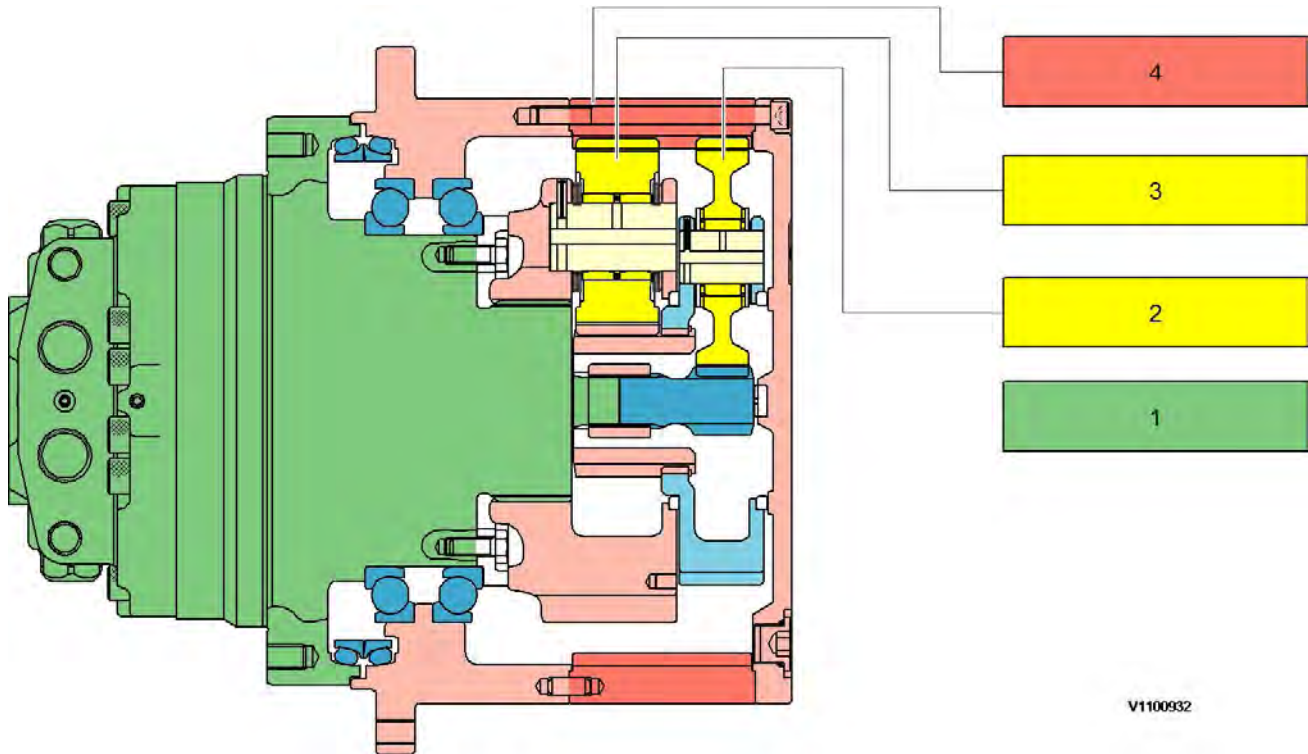

Figure 1
2 stage planetary gearbox

1. Track motor
2. No.1 planetary gear assembly
3. No.2 planetary gear assembly
4. Ring gear

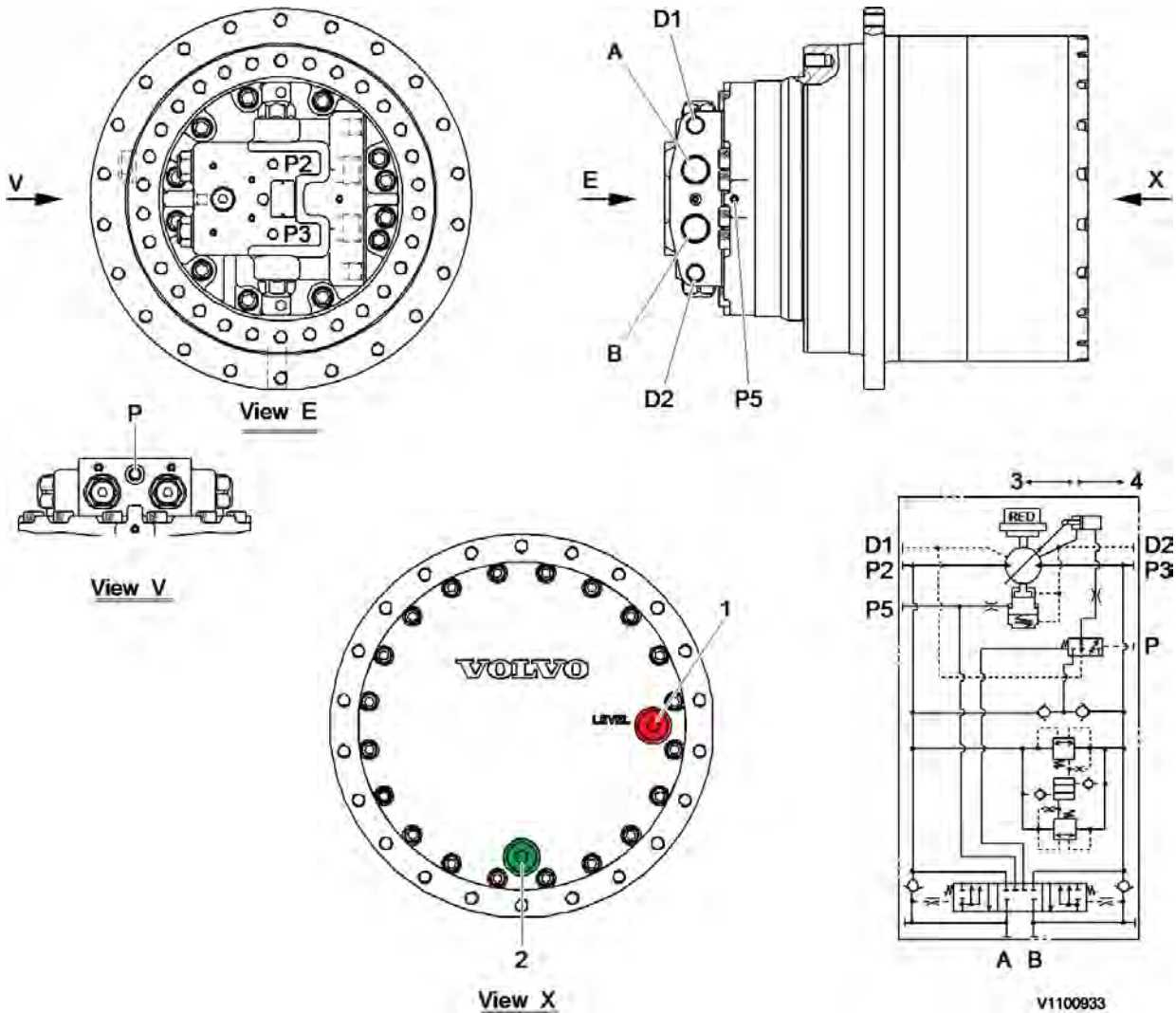

Figure 2
Port connections

1. Oil level check and oil filling port (PF 3/4): 186 Nm (19 kgf m)
2. Oil drain port (PF 3/4): 186 Nm (19 kgf m)
3. High speed
4. Low speed

Port connections

Port symbol	Port size	Port
(A), (B)	1-5/16-12 UN	Oil supply (return)
(P2), (P3)	PT 1/4	Pressure check
(P5)	PT 1/8	Parking brake release pressure Parking brake can be released manually when supply pressure minimum 1.47 MPa (14.99 kgf cm ²) (213.2 psi) (14.7 bar) to port P5.
(P)	7/16-20 UNF	Displacement changeover valve oil supply
(D1), (D2)	3/4-16 UNF	Motor drain

Rotational direction

View from E axis	Inlet	Outlet
Clockwise	A	B
Counterclockwise	B	A

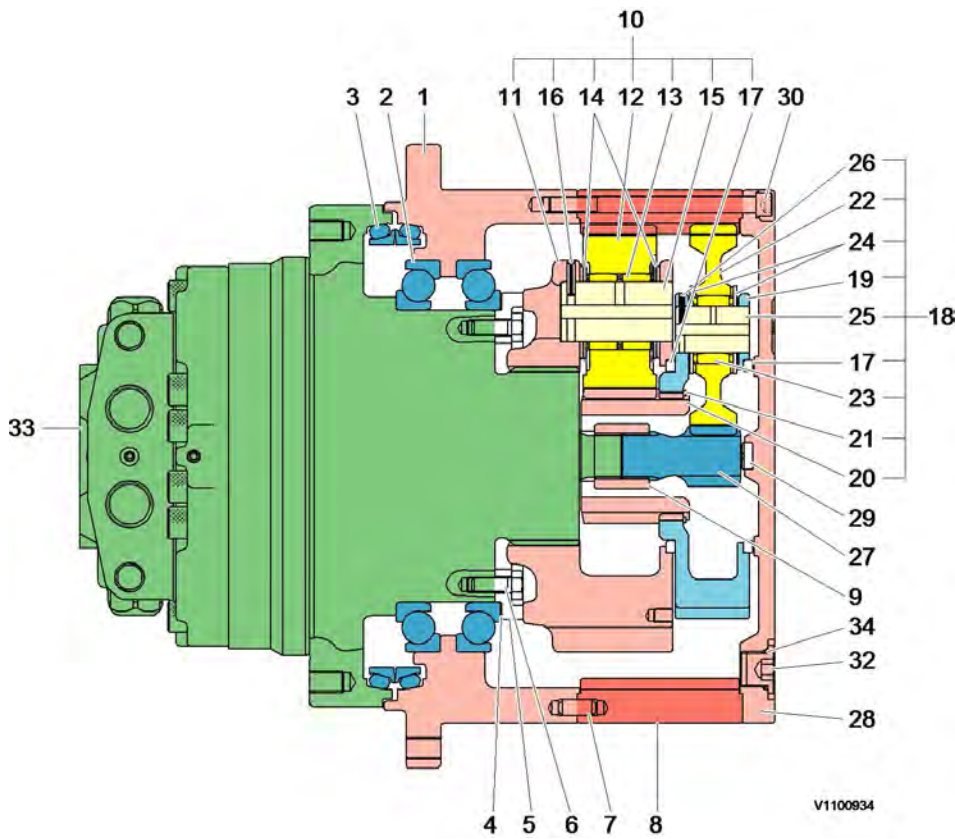

Figure 3
Track gearbox, sectional view

1	Housing	13	No.2 needle bearing	25	No.1 pin
2	Angular bearing	14	Thrust washer	26	Spring pin
3	Seal	15	No.2 pin	27	No.1 sun gear
4	Shim	16	Spring pin	28	Cover
5	Retainer	17	Thrust ring	29	Pad (thrust)
6	Screw 113 Nm (11.5 kgf m)	18	No.1 planetary gear assembly	30	Screw 132 Nm (13.5 kgf m)
7	Parallel pin	19	No.1 carrier	31	–
8	Ring gear	20	No.2 sun gear	32	Plug 186 Nm (19 kgf m)
9	Coupling	21	Retaining ring gear	33	Name plate
10	No.2 planetary gear assembly	22	No.1 planetary gear	34	O-ring
11	No.2 carrier	23	No.1 needle bearing		
12	No.2 planetary gear	24	Thrust washer		

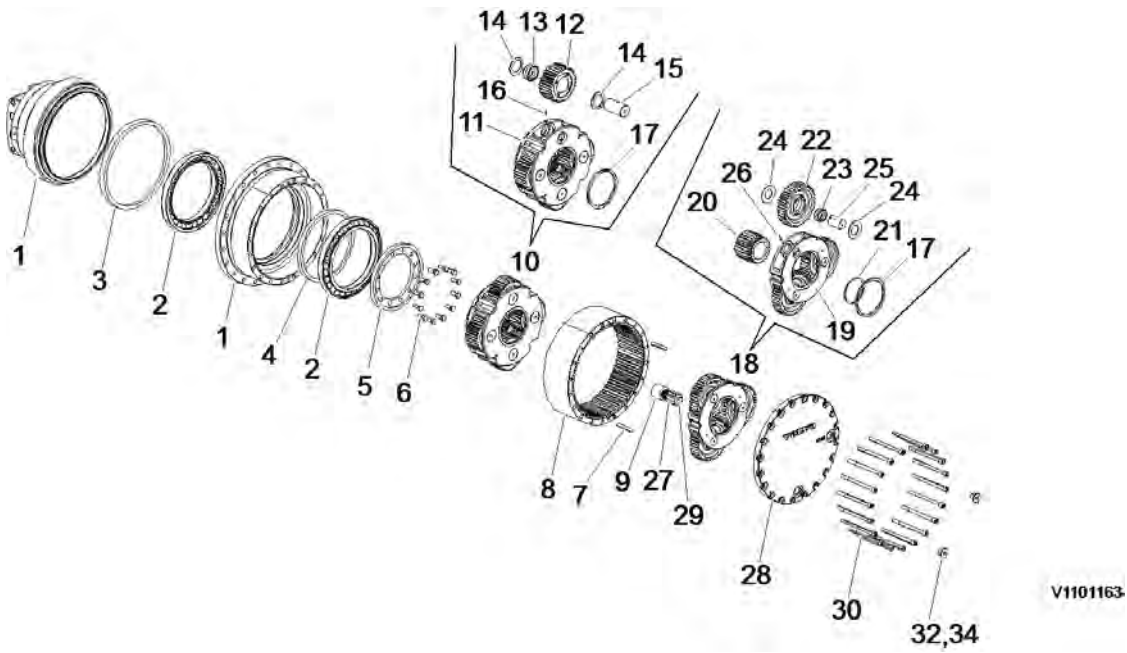

Figure 4
Track gearbox, exploded view

The power transmitted from the hydraulic motor output shaft is transmitted to the 1st stage sun gear (27) → spline of 1st carrier (19) → 2nd sun gear (20) → 2nd planetary gear (12) → ring gear (8).

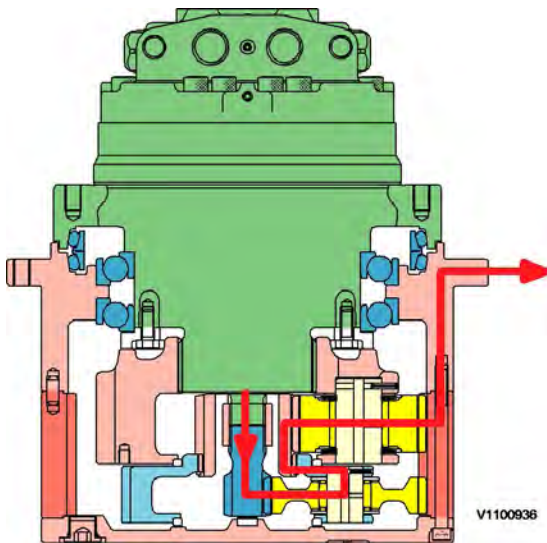

Figure 5
Track gearbox, torque flow

At this time, the reduction ratio of reduction gear is as follows:

(1) 1st reduction ratio

$$i_1 = ((Z_{s1} + Z_r) \cdot (Z_{s2} + Z_r) / (Z_{s1} \cdot Z_{s2})) - 1$$

- Z_{s1} = No. of tooth of 1st sun gear
- Z_{s2} = No. of tooth of 2nd sun gear
- Z_r = No. of tooth of ring gear

Document Title: Track gearbox, maintenance standard	Function Group:	Information Type: Service Information	Date: 2014/6/13
Profile: EXC, EC220D L [GB]			

Track gearbox, maintenance standard

Track gearbox, maintenance standard

The parts are precision finished and must be handled carefully.

Keep the parts of the planetary carrier (s) together, do not mix the bearings, gears, pins and thrust washers.

Seals

Replace the seals and O-rings, although they appear not damaged.

Part replacement criteria

Replace all parts that appear damaged or are not within the allowable value.

Replace some parts in sets, i.e. gears, bearings, pins and thrust washers.

Part replacement criteria

No.	Part	Condition	Allowable value
8 12 20 22 27	Ring gear No.2 planetary gear No.2 sun gear No.1 planetary gear No.1 sun gear	The tooth surface is pitted or non uniformly worn. The gear is cracked.	Area rate: within 5%
23 13 2	Needle bearing Needle bearing Angular bearing	Fitting/flaking of the balls, rollers or races. Does not rotate smoothly by hand.	
3	Seal	Rust or damage on sliding face. O-ring distorted or damaged.	
15 25	No.2 pin No.1 pin	The pin is cracked, galled or pitted.	
24 14	Thrust washer	Excessively worn on the face area.	

General tools

General tools

No.	Item	Size	Quantity
1	Socket wrench	19 mm (0.75 inch)	1
2	L wrench	5 mm (0.2 inch) 10 mm (0.39 inch) 12 mm (0.47 inch)	1
3	Torque wrench	39 ~ 177 Nm (29 ~ 130 lbf ft)	1
4	Eye bolt	PF 3/4 M10 M12	2
5	Plastic hammer	Approximately L = 300 ~ 500 mm (11.8 ~ 19.7 inch)	1
6	Screwdriver	Approximately L = 200 mm (7.9 inch)	1
7	Depth gauge (Vernier calliper)	Range approximately 300 mm (11.8 inch) Minimum scale 0.01 mm (0.00039 inch)	1

Track gearbox, precautions for operation

Installation

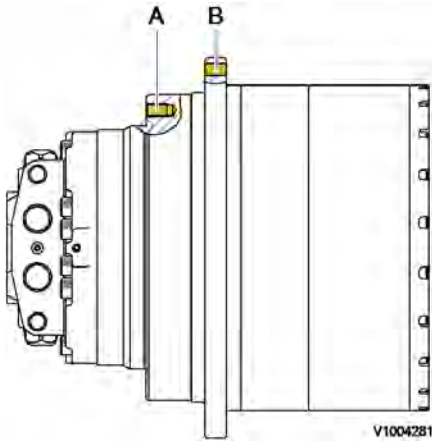

Figure 1

Mounting location

- A. Main body mounted area
- B. Sprocket mounted area

- Check that the mating mount surfaces are clean.
- Check that the motor is positioned correctly in the frame.
- If the gearbox to frame fit is tight, draw the assembly into the frame evenly with the mounting screws.
- Tighten the screws in a crisscross pattern in several stages to the specified torque.
- Apply these same precautions when mounting the sprocket.

Tightening torque

Tightening torque

Reduction screw (A). See 700 Undercarriage, tightening torque

Sprocket screw (B). See 700 Undercarriage, tightening torque

NOTE!

The screws must be 10.9 KS strength classification or above.

Lubricating oil

NOTICE

Prior to operating the travel function, fill the gearbox with the specified oil to the correct level.

NOTE!

Gear oil specification

Use a gear oil equivalent to API classification GL-4 or GL-5, SAE 90.

Gear oil replacement period

- First (initial) oil replacement: 500 operating hours
- Subsequent oil replacement: 2000 operating hours
- After maintenance (initial): 250 operating hours

NOTE!

Regardless of the operating hours the gear oil must be replaced at least once per year.

NOTE!

Do not mix different types, classifications or brands of oil.

NOTE!

Drain the gear oil while it is still warm to flush out any contaminants.

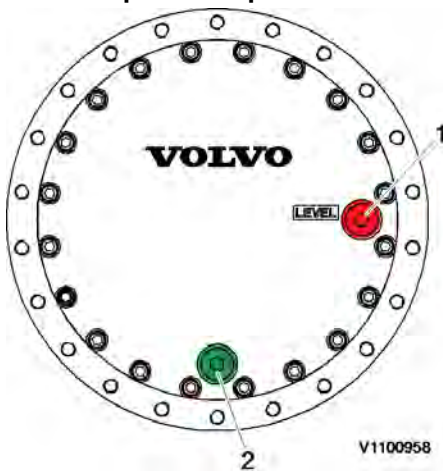
Gear oil replacement procedure**Figure 2****Oil replacement location**

1. Level check port and fill port
 2. Drain port
- Rotate the gearbox until the drain plug is the lowest position on the ground.
 - Remove the 2 plugs and drain the oil into a suitable container.
 - Ensure that the drain plug O-ring is not damaged, then install the plug with specified tightening torque.
 - Refill the gearbox through the fill port until oil exits from the level check port.
 - Ensure that the O-ring on each plug is not damaged, then install the plugs with specified tightening torque.

NOTE!

Oil capacity. See [4311 Track gearbox specifications](#).

Operating checks

- Check the oil level prior to operating the travel function.
- Check for oil leakage on the gearbox assembly.
- Check for loose mounting screws.
- Check for abnormal sound or vibration while rotating.
- Check for any abnormal temperature increase after operating for a short time.

! WARNING

The temperature of the case is high just after running. Use a thermometer to measure. Do not touch directly by hand to prevent a burn injury.

NOTE!

The temperature of the case must be lower than 90 °C, during continuous operation.

Remove air in the track motor before operating.

1. Check that the gearbox axis is horizontal. Rotate the gearbox housing until the drain plug is on the bottom of the vertical axis of the end cover.
The gearbox is supplied with oil plugs (draining, filling and level) equipped with an hole that allows the air to bleed.

NOTE!

Remove the oil plugs with care. When the gearbox is warm, the air inside can be pressurized and this can cause their strongly expulsion towards the worker.

2. Loosen with caution the plugs (2~3 rounds) counterclockwise.
3. Clean the plug to be sure that the air bleed hole is not obstructed.
4. Wait a few seconds to allow the pressurized air to bleed from the gearbox.
5. Remove the plugs and let the oil flow in a large enough container; in order to facilitate the draining must be oil still warm.
6. Wait a few minutes until all the oil is drained and then proceed to screw on the plugs.
7. Proceed with the oil fill-up following the procedures given.

NOTE!

Never mix mineral oils with synthetic oils and vice versa.

Do not dispose of the oil in the natural environment but be careful to eliminate it in compliance with the relative rules and regulations that govern locally.

Tightening torque plug. See track gearbox, description.

Track gearbox, troubleshooting

Gearbox does not rotate.	Motor overloaded.	Reduce the load.
	Gearbox is damaged.	Replace the gearbox.
Oil leakage from mating joint surfaces.	Liquid gasket improperly applied.	Disassembly and re-apply.
	Mating surface damaged.	Repair or replace.
	Loosen screws.	Tighten to specified torque.
	Loosen plug.	Tighten to specified torque.
Casing leakage.	Cracks or pin holes.	Replace the housing.
	Cover damaged.	Replace the cover.

Track gearbox, troubleshooting

Floating seal leakage.	Sliding surface worn.	Replace the floating seal assembly.
	O-ring distorted.	

Document Title: Track unit, replacing	Function Group:	Information Type: Service Information	Date: 2014/6/13
Profile: EXC, EC220D L [GB]			

Track unit, replacing

Op nbr 431-127

[14566479 Pin kit](#)

[14560748 Track pin press](#)

[14548448 Pump](#)

1. Park the machine in the service position F. See [091 Service positions](#).
2.
 - When the engine is running, the hydraulic line is under high pressure. Stop the engine, and remove the residual pressure inside the hydraulic line by operating the control lever smoothly 3-4 times with the ignition switch at "ON" position. Turn the ignition switch to "OFF" position.
 - Remove the residual pressure inside the hydraulic tank by pressing the air breather on the hydraulic tank.
 - After disconnecting the hose, install a plug to prevent oil leakage and contamination.

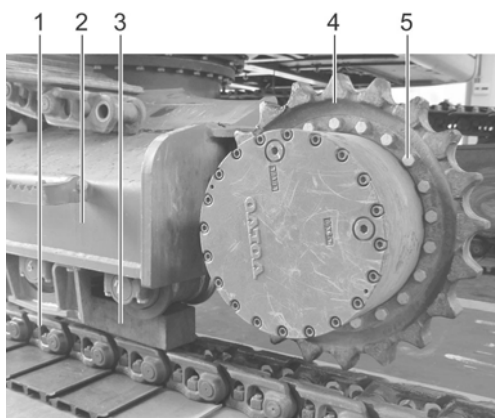

3.

V1100897

Figure 1
Removal, sprocket

1. Track link
2. Track frame
3. Wood block
4. Sprocket
5. Screws

Remove the track shoes over the master pin and remove the pin to split the track chain. Insert a bar into the track link to guide the track assembly. Rotate the track backward to remove the track chain from the drive sprocket.

See [7753 Track chain assembly, removing](#) to remove the master pin and the track chain.

4. Raise the sprocket and insert block between track frame and link to support the undercarriage.
5. Remove the screws rotating sprocket and remove sprocket carefully.
6. Remove the screws and motor cover.

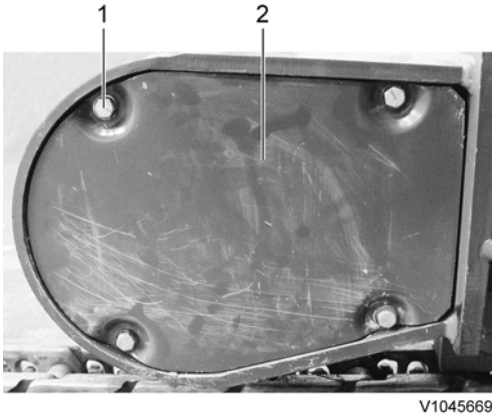

Figure 2
Removal, motor cover

1. Screws
2. Motor cover

7. Remove the track motor high pressure hoses.

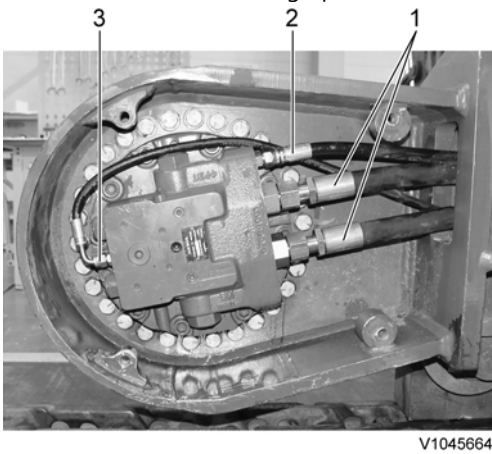

Figure 3
Removal, hoses

1. High pressure hoses
2. Drain hose
3. 2nd speed hose

8. Remove the track motor drain hose.

9. Remove the track motor 2nd speed hose.

10. Remove the fittings.

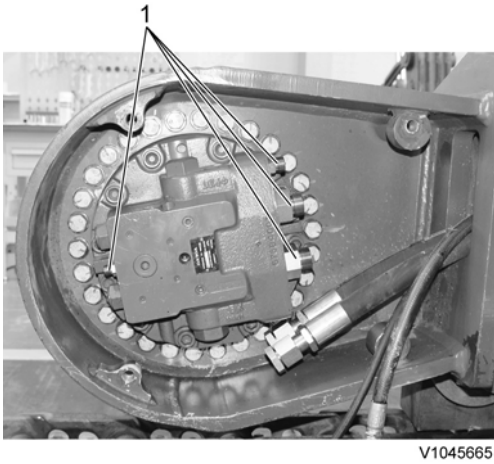

V1045665

Figure 4
Removal, fittings

1. Fittings

11. Hold the track unit with hoist and remove mounting screws of the track unit from track frame.

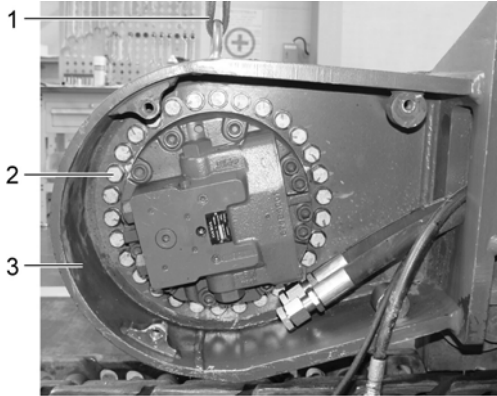

V1045666

Figure 5
Removal, mounting screws

1. Hoist
2. Screws
3. Track frame

12. Lift the track unit with hoist, and lower to the workbench safely.

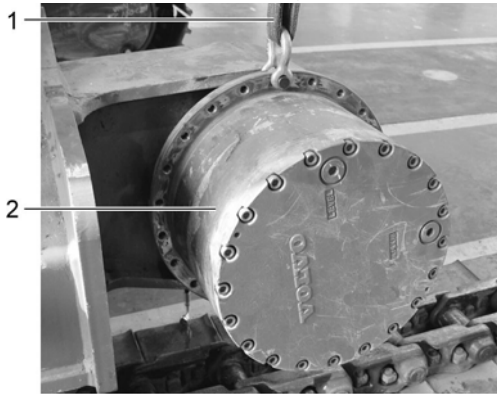

V1100923

Figure 6
Removal, track unit

1. Hoist

2. Track unit

13. Install a new track unit in reverse order of the removal procedure.
14. Lift the track chain onto the drive sprocket, insert a bar into the track link to guide the track assembly. Rotate the track forward until the master pin link is at the idler. Install the master pin and the track shoes.
See [7753 Track chain assembly, installing](#) to install the master pin and the track chain.
15. Check the operation of the track and motor.

Document Title: Track gearbox, replacing cover	Function Group:	Information Type: Service Information	Date: 2014/6/13
Profile: EXC, EC220D L [GB]			

Track gearbox, replacing cover

Op nbr 431-117

1. Park the machine in the service position B See [091 Service positions](#).
Rotate the gearbox until the drain plug and fill plug are on the vertical axis.

2. Remove the plugs on the cover and drain the oil into a suitable container.

NOTE!

Oil capacity. See [4311 Track gearbox specifications](#).

Prepare container for collecting hydraulic oil.

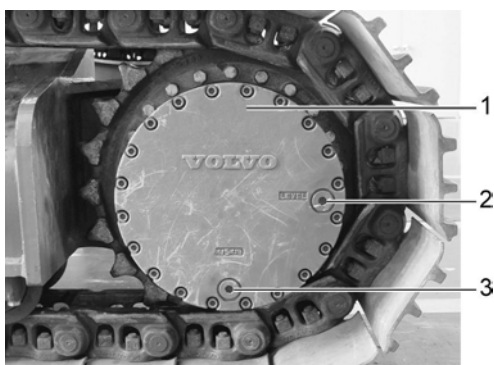

Figure 1
Removal, plugs

1. Track gearbox cover
2. Level check port
3. Fill and drain port

3. Remove the gearbox cover screws.

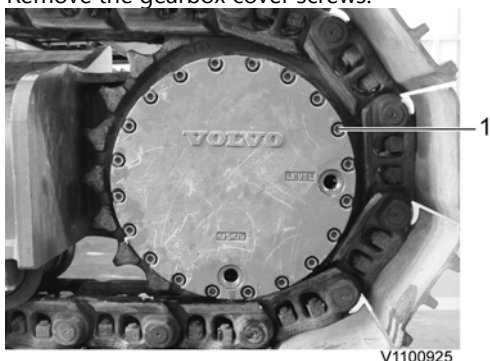

Figure 2
Removal, screws (1)

4. Remove the gearbox cover from track gearbox.

WARNING

The parts are heavy. Take appropriate safety cautions when handling them.

5. **NOTE!**

Thoroughly clean the mounting surface.

Install the new gearbox cover to the track gearbox.

NOTE!

Before replacing cover, apply sealing compound to the mounting surface.

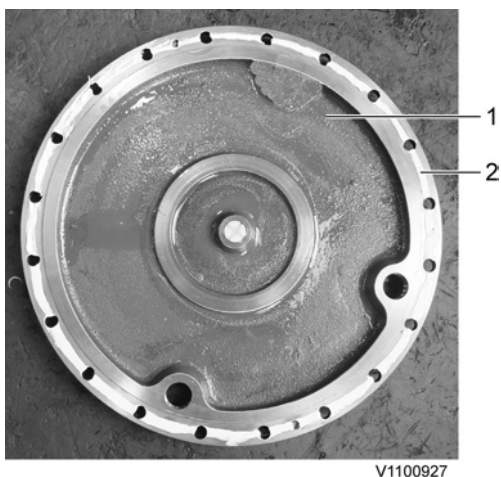

Figure 3
Applying, sealing compound

1. Track gearbox cover
2. Sealing compound

6. Install the level check port and tighten it to the specified torque.

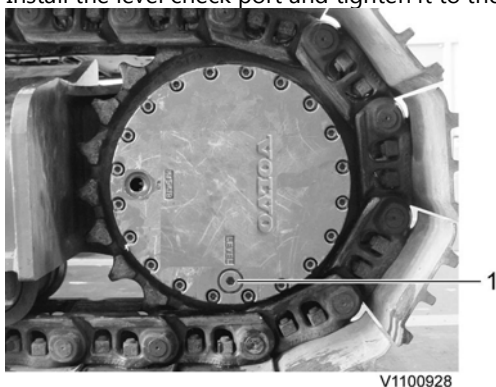

Figure 4
Installation, level check port plug (1)

7. Fill the oil through the fill port until oil exits from the fill port. See [4311 Track gearbox, specifications](#).
8. Install the fill plug and tighten them to the specified torque. See [4311 Track gearbox, description](#).

Document Title: Track gearbox (removed), replacing floating seal	Function Group:	Information Type: Service Information	Date: 2014/6/13
Profile: EXC, EC220D L [GB]			

Track gearbox (removed), replacing floating seal

Op nbr 431-115

[8932-00290 Measuring plate](#)

Tool: 14630696 Drift plate

1. Remove the 2 plugs on the cover and drain the oil into a suitable container.

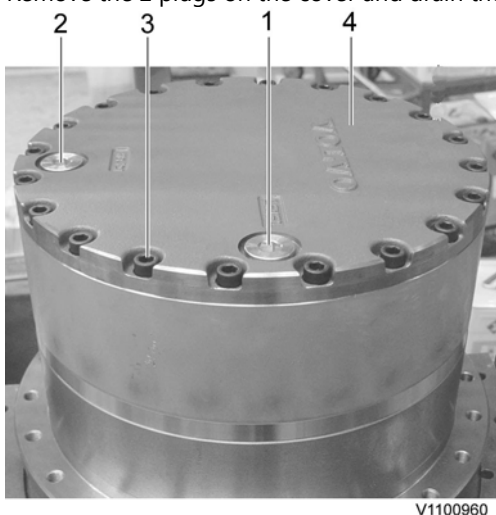

Figure 1
Removal, cover

1. Level check port and fill port
2. Drain port
3. Screw
4. Cover

NOTE!

Prepare container for collecting hydraulic oil.

Oil capacity. See [4311 Track gearbox, specifications](#).

2. Remove the screws and cover.
3. Remove the No.1 planetary gear assembly.

Thank you very much for reading.

This is part of the demo page.

GET MORE:

Hydraulic

System, Setting

Instructions, Functional

Description, Electrical

System And more.....

Click Here BUY NOW

Then Instant Download

the Complete Manual.

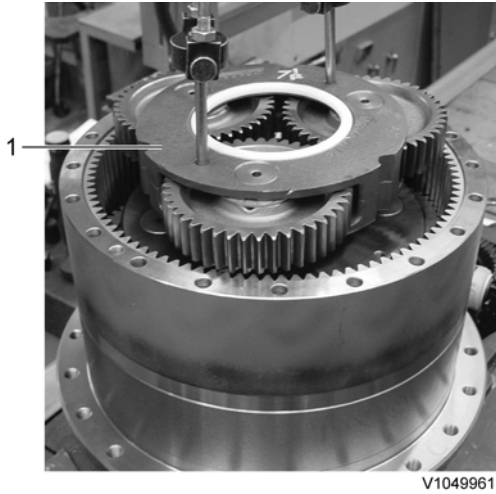

V1049961

Figure 2
Removal, No. 1 planetary gear assembly (1)

4. Remove the No.1 sun gear and coupling.

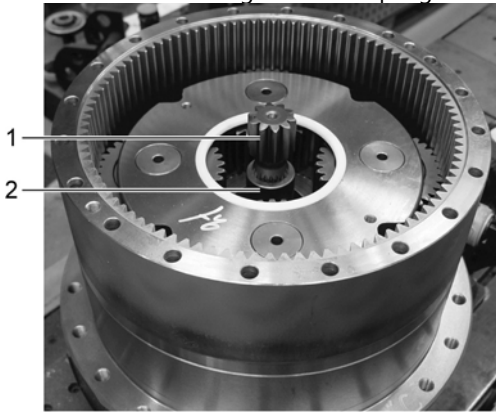

V1049962

Figure 3
Removal, No.1 sun gear (1) and coupling (2)

5. Screw the eye bolts into ring gear, and remove ring gear using a plastic hammer.

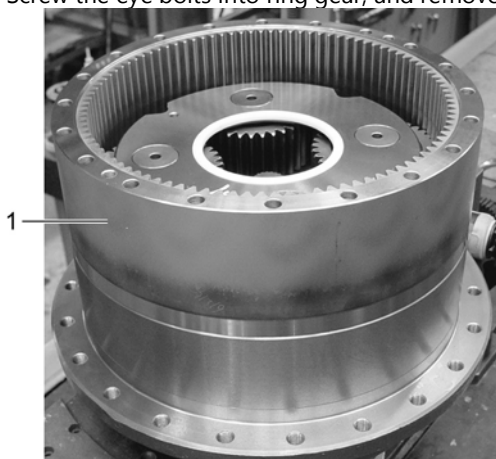

V1049964

Figure 4
Removal, ring gear (1)

6. Remove the No.2 planetary gear assembly.

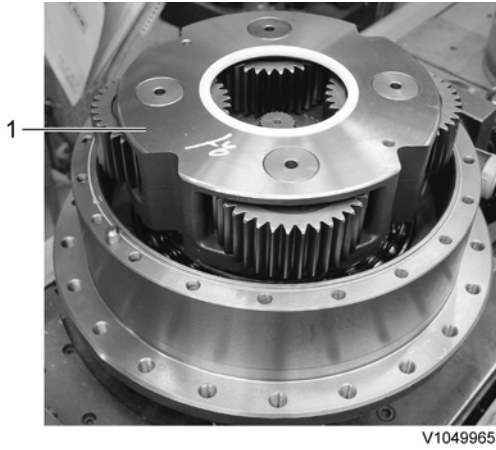

V1049965

Figure 5
Removal, No.2 planetary gear assembly (1)

7. Remove the screws, retainer and the shim.

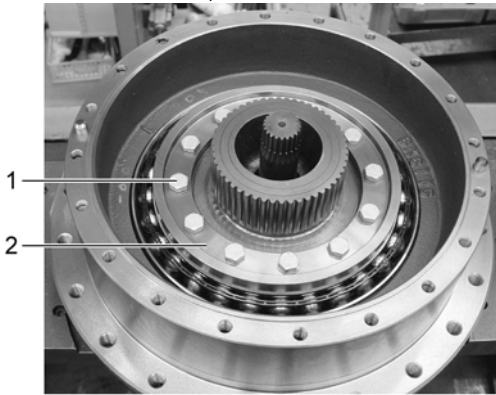

V1049967

Figure 6
Removal, screws (1) and retainer (2)

8. Screw the eye bolts into housing and then remove housing.

NOTE!

When difficult to remove, lift the body vertically and tap lightly with a plastic hammer.



The parts are heavy. Take appropriate safety precautions.

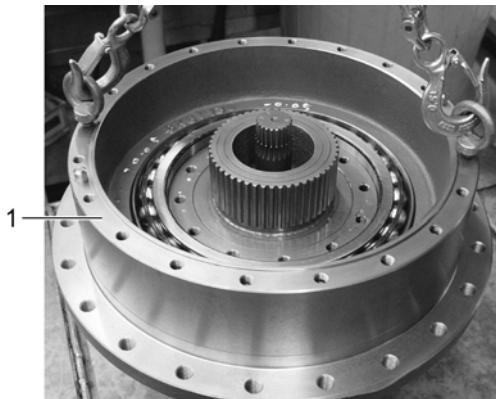

V1049968

Figure 7
Removal, housing (1)

9. Replace the seal from housing.