

Document Title: Engine, description	Function Group: 200	Information Type: Service Information	Date: 2014/12/23
Profile: EXC, EC360C L [GB]			

Engine, description

- The D12D is the model number of the Volvo 12 liter engine.
- The engine is a 6-cylinder, 4-stroke, direct injection diesel with a 12 liter cylinder volume, turbocharger, charge air cooler and electronic controlled fuel injection, EMS (Engine Management System).
- The serial number of the engine is to be found stamped in the cylinder block on the rear left side.
- The cylinder head is of cast iron and manufactured in one piece which is necessary in order to provide stable bearings for the overhead camshaft.
- The cylinder liner is sealed against the coolant casing with rubber rings.
- The D12D has a four-valve system and overhead camshaft.
- The engine timing gear transmission is located at the front of the engine on a 10 mm thick steel plate bolted to the cylinder block.
- The crankshaft is drop forged and has induction hardened bearing surfaces and fillets.
- The engine is force fed lubricated by an oil pump which is gear driven from the engine crankshaft via an intermediate gear
- The fuel system for D12D has electronic control with unit injectors one for each cylinder and which operate at a very high pressure.
- The fuel feed pump is a gear driven type and is driven from the engine timing gear with the same gear.

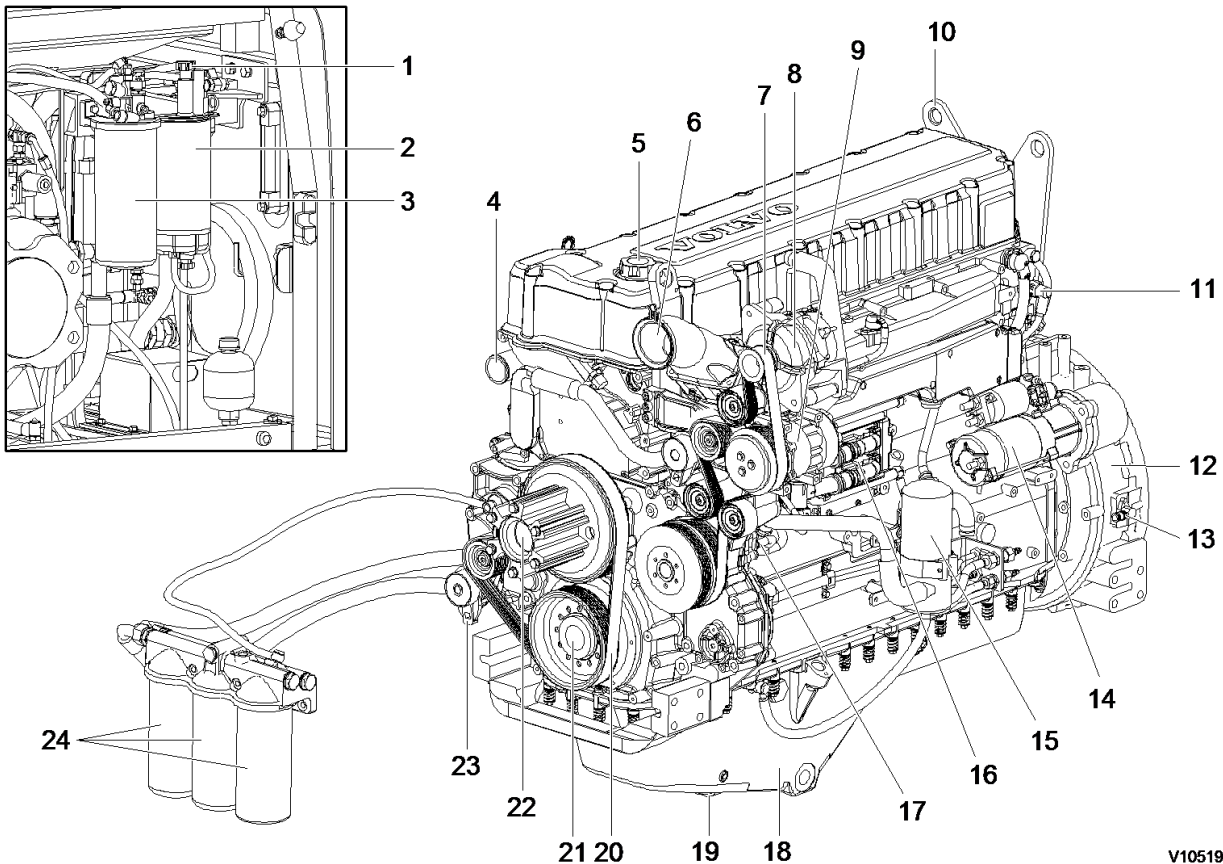

V1051975

Figure 1
Engine, structure

1	Hand pump	9	Air conditioner compressor	17	Fuel feed pump
2	Water separator	10	Lifting bracket	18	Oil pan
3	Fuel filter	11	Coolant temperature sensor	19	Engine oil drain valve
4	From radiator	12	Flywheel housing	20	Fan belt
5	Engine oil filler	13	Speed sensor	21	Crankshaft pulley
6	From charge air cooler	14	Starter motor	22	Fan drive and pulley
7	Alternator belt	15	Breather	23	Belt tensioner
8	Alternator	16	E-ECU	24	Engine oil filter

Document Title: Engine, identification	Function Group: 200	Information Type: Service Information	Date: 2014/12/23
Profile: EXC, EC360C L [GB]			

Engine, identification

Identification plate

The engine model, serial number and performance data are stamped on an identification plate which is attached on the cylinder head cover. The engine model designation and serial number must be indicated when ordering spare parts.

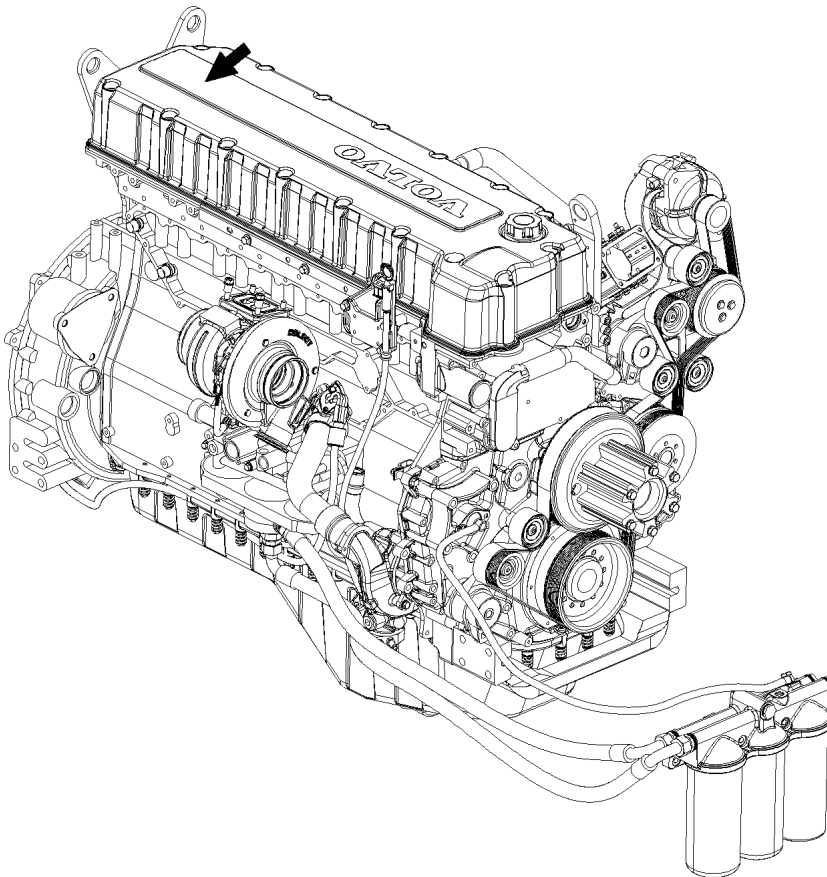

V1051986

Figure 1
Engine identification plate location

Document Title: Engine, removing	Function Group: 210	Information Type: Service Information	Date: 2014/12/23
Profile: EXC, EC360C L [GB]			

Engine, removing

Op nbr 210-070

[9998257 Lifting tool](#)

[9998547 Lifting device](#)

! WARNING

Risk of burns - stop the diesel engine and allow it to cool down before starting any work.

! WARNING

Removal of residual pressure from the circuit must be done prior to any maintenance.

NOTE!

Cable ties and clamps that secure hoses and electrical wiring must be removed and then replaced when installing.

1. Place the machine in the service position B. See [091 Service positions](#)
2. Turn off the battery disconnect switch.
3. Loosen two screws and connect hose (1), and then drain the hydraulic oil into a suitable collection container.

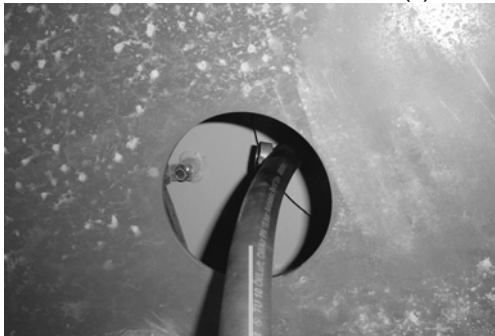

V1043812

1

Figure 1
Hydraulic oil tank, drain

4. Drain the coolant in a collection container.
5. Remove under cover (1).

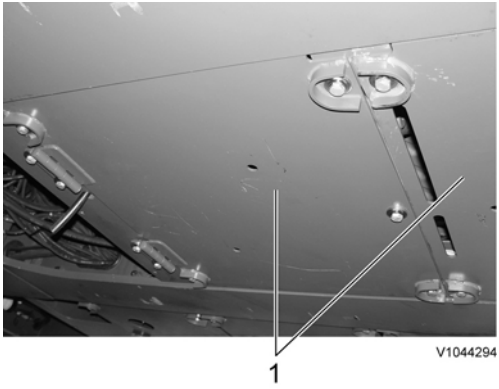

Figure 2
Removal, under cover

6. Remove silencer hood (1).



Figure 3
Removal, silencer hood

7. Remove screws (1) and open radiator hood (2).

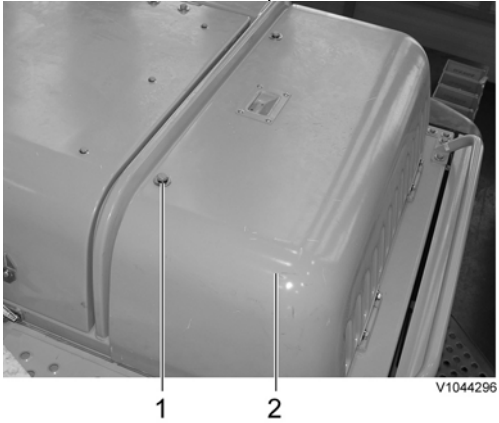

Figure 4
Opening, radiator hood

8. Remove the rear cover of the engine hood.

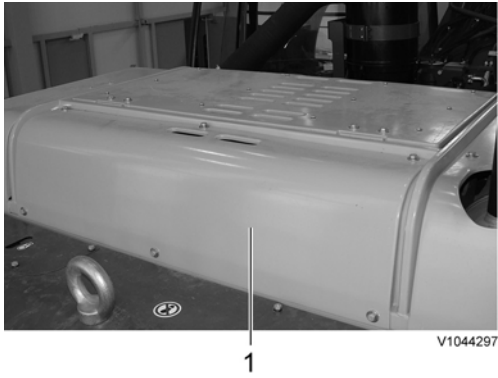

Figure 5
Removal, cover

9. Open the engine hood and remove the cowl mounting screws.
10. Remove cowl (1) using a lifting device.
11. Disconnect wire harness connector (2), hoses (3), and remove expansion tank (1) with the bracket.

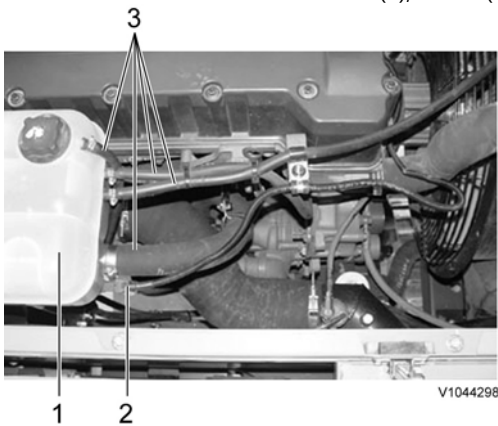

Figure 6
Removal, expansion tank

12. Remove foot step (1).

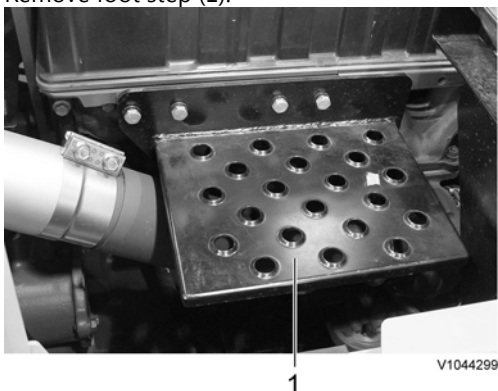

Figure 7
Removal, step

13. Disconnect radiator hose (2) and upper charge air cooler hose (1).

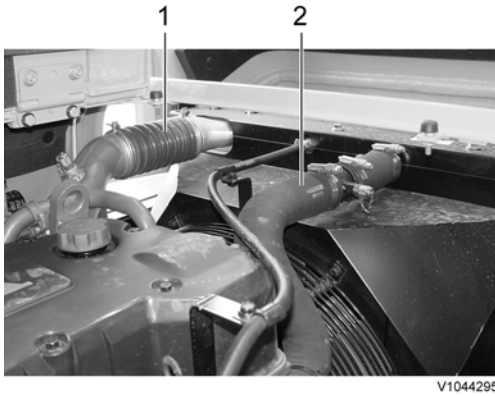

Figure 8
Removal, radiator and charge air cooler hose

14. Disconnect hose (1) of engine oil remote filter bypass.



Figure 9
Disconnect, hose

15. Remove radiator fan guard (1).

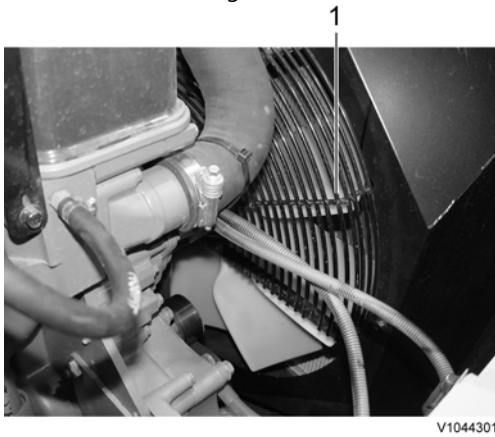

Figure 10
Removal, radiator fan guard

16. Remove radiator fan (1).

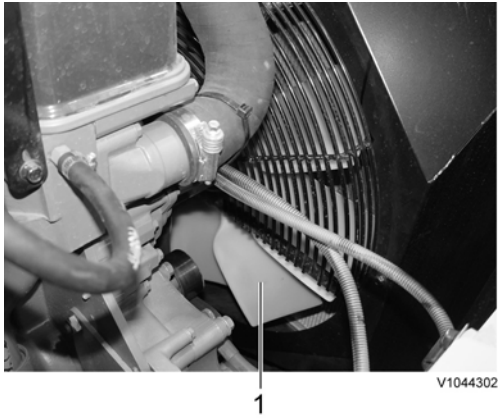

Figure 11
Removal, radiator fan

17. Disconnect turbocharger inlet hose (1).

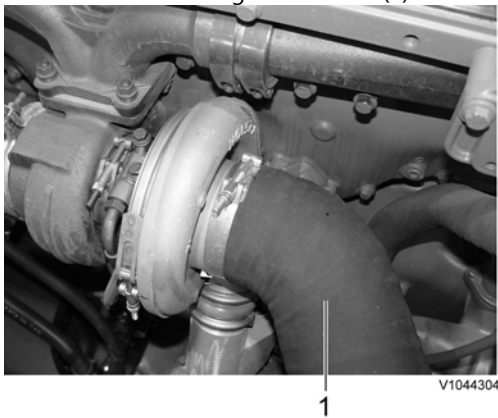

Figure 12
Disconnect, hose

18. Disconnect cab heater hoses on the engine block and coolant pump.

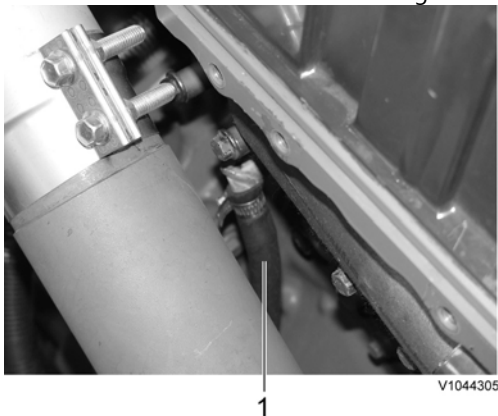

Figure 13
Disconnect, hose

1. Cab heater hose on engine block
19. Open the machine right side cover.
20. Remove the main pump. See [913 Hydraulic pump, replacing](#)
21. Disconnect the fuel line hoses (4 pcs).
NOTE!

Ports must be plugged after disassembling hoses.

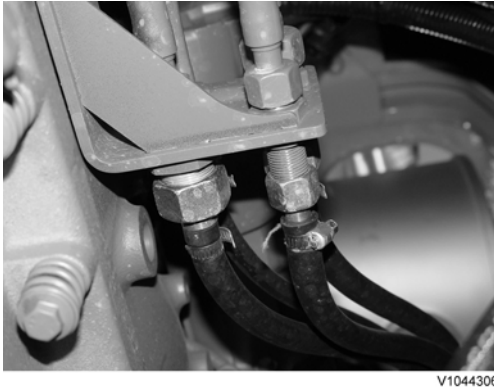

Figure 14
Disconnect, hose

22. Remove the pump gearbox coupling. See [442 Pump gearbox coupling assembly, replacing](#).
23. Disconnect starter motor wire harness (1).

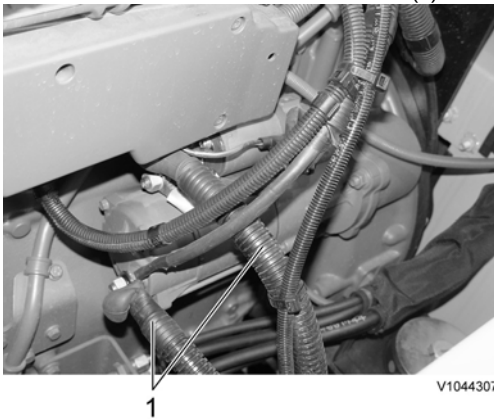

Figure 15
Removal, wire harness

24. Disconnect inlet hose (2), outlet hose (1) on the engine PTO pump.

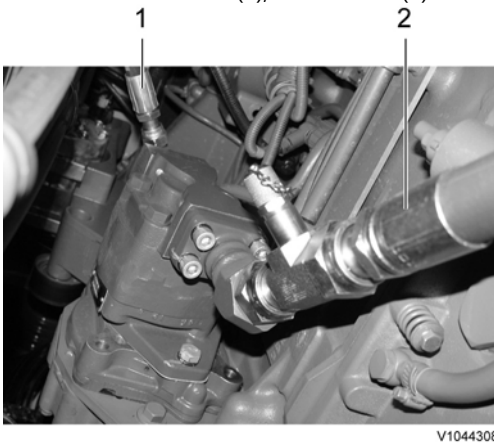

Figure 16
Removal, inlet and outlet hose



Do not disconnect or loosen connections for the air conditioning unit (AC). Risk of gas leakage.

25. Remove the compressor from the engine.

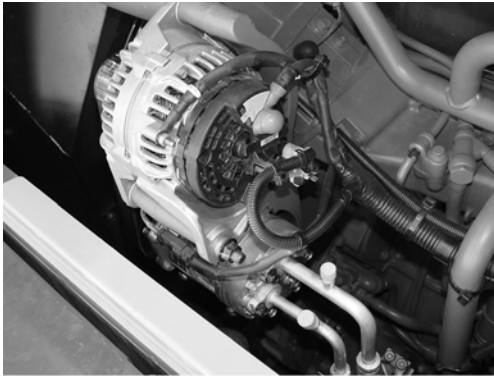

Figure 17
Removal, compressor

26. Disconnect the wire harness for all engine sensors.
27. Remove cover (1) and disconnect main wire harness (2).

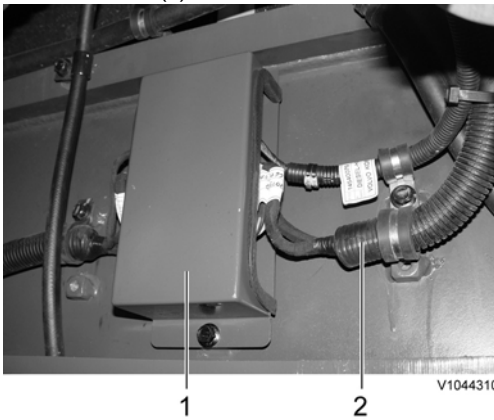

Figure 18
Removal, cover

28. Disconnect radiator lower hose (1) and charge air cooler lower hose (2).

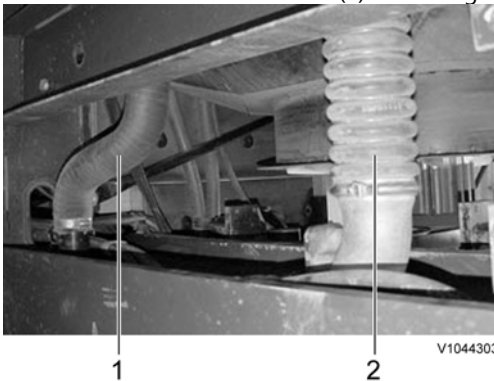

Figure 19
Disconnect, radiator and charge air cooler hose

1. Radiator hose
2. Charge air cooler hose

29. Disconnect the engine oil remote hose (1).

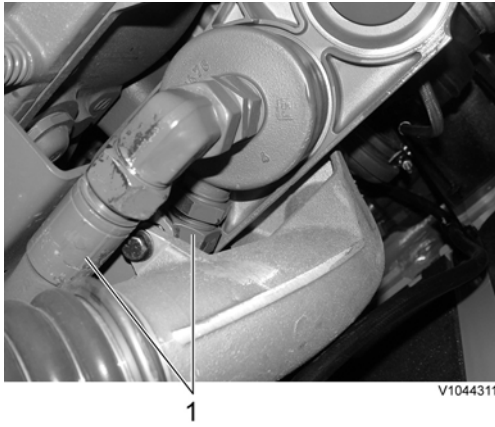

Figure 20
Disconnect, hose

30. Remove the engine mounting screws (4 places).

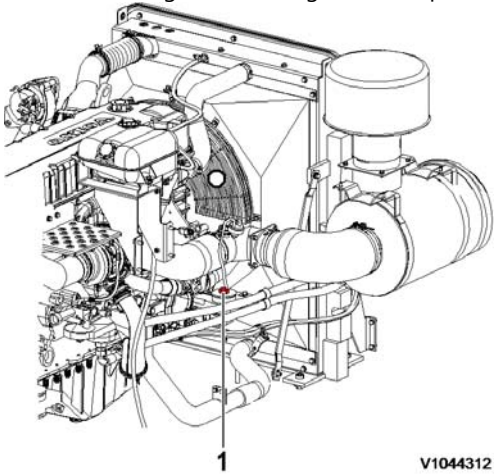

Figure 21
Removal, mounting screws



The parts are heavy. Take appropriate safety precautions.

31. Fit tool 9998257 and connect 9998547 and a lifting device to the engine and remove the engine slowly.

Document Title: Engine, installing	Function Group: 210	Information Type: Service Information	Date: 2014/12/23
Profile: EXC, EC360C L [GB]			

Engine, installing

Op nbr 210-072

[9998257 Lifting tool](#)

[9998547 Lifting device](#)

NOTE!

Cable ties and clamps that secure hoses and electrical wiring must be removed and then replaced when installing.



WARNING

The parts are heavy. Take appropriate safety precautions.

1. Fit tool 9998257 and connect lifting device 9998547 and hoist the engine slowly and install the engine.
2. Install the engine mounting screws (4 places).

NOTE!

Pay attention to the positioning of the brackets, cushions, and mounting screws (front/rear) when assembling.

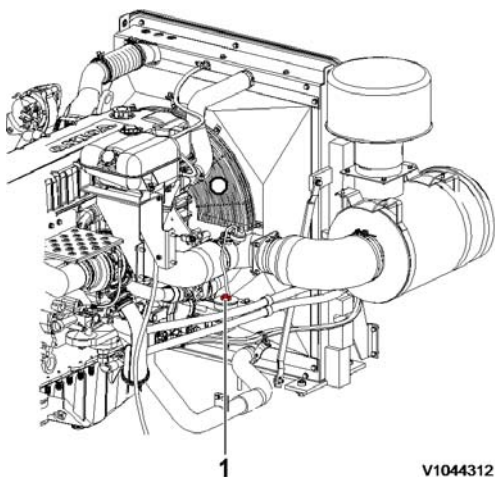

Figure 1
Installation, engine

3. Connect engine oil remote hose (1).

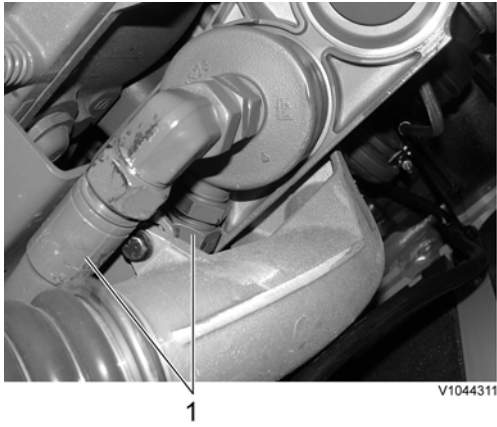

Figure 2
Connect, hose

4. Connect radiator lower hose (1) and charge air cooler lower hose (2).

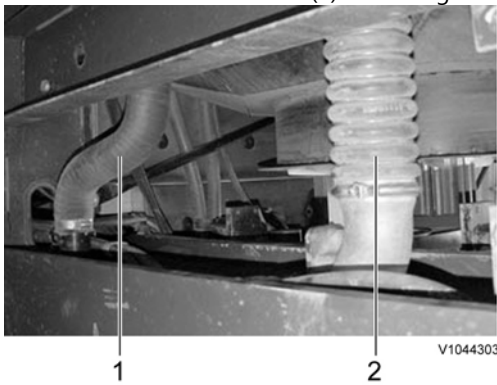

Figure 3
Connect, hose

1. Radiator hose
2. Charge air cooler hose

5. Install cover (1) and connect main wire harness (2).

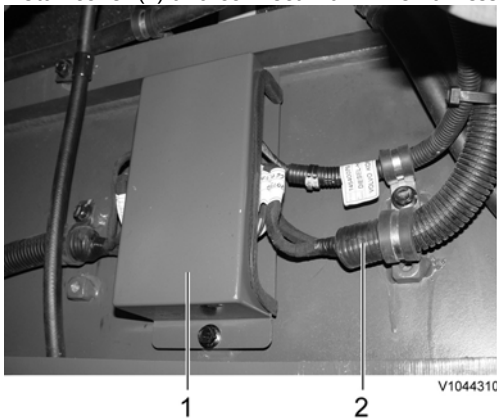
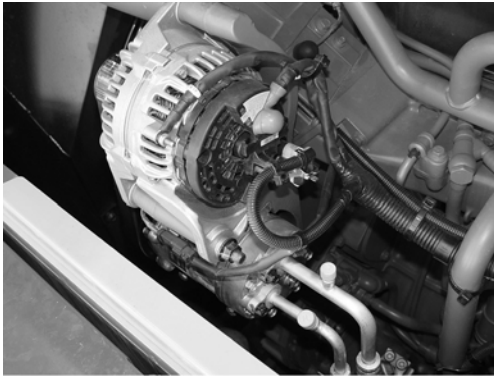

Figure 4
Installation, wire harness and cover

6. Connect wire harness for all sensors to the engine.
7. Install the compressor to the engine.



V1044309

Figure 5
Installation, compressor

8. Connect inlet hose (2) and outlet hose (1) of the engine PTO pump.

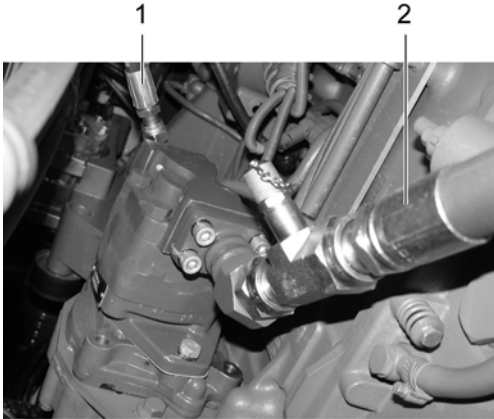

V1044308

Figure 6
Connect, hose

9. Connect wire harness (1) to the starter motor.

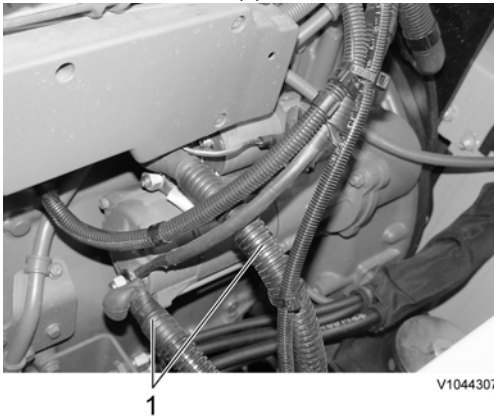

V1044307

Figure 7
Connect, wire harness

10. Connect the fuel line hoses (4 pcs).

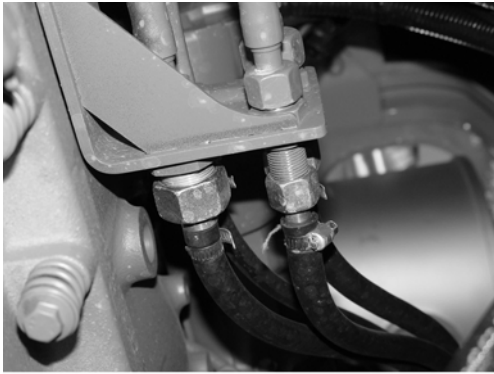

V1044306

Figure 8
Connect, fuel hose

11. Install the pump gearbox coupling. See [442 Pump gearbox coupling assembly, replacing](#)
12. Install the main pump. See [913 Hydraulic pump, replacing](#)
13. Connect the cab heater hoses to the engine block and water pump rear side.

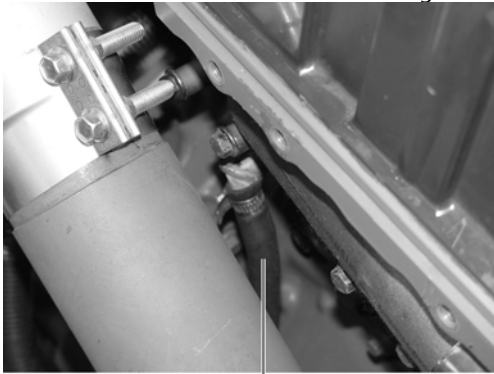

V1044305

Figure 9
Connect, hose

1. Cab heater hose on engine block
14. Connect turbocharger inlet hose (1).



V1044304

Figure 10
Connect, hose

15. Install radiator fan (1).

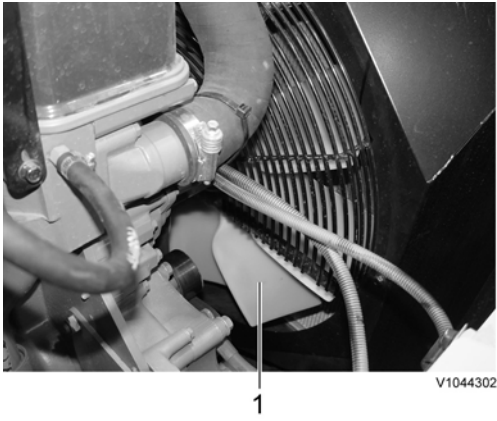

Figure 11
Installation, radiator fan

16. Install radiator fan guard (1).

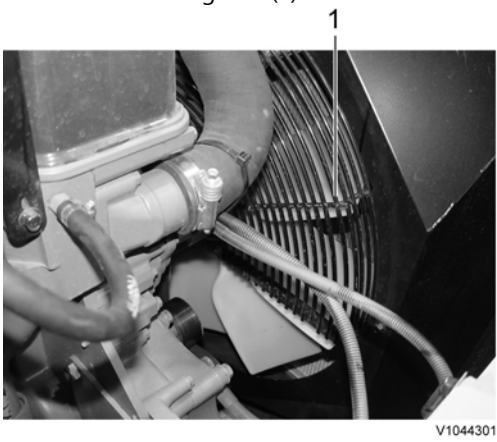

Figure 12
Installation, radiator fan guard

17. Connect hoses (1) for remote engine oil bypass filter.



Figure 13
Connect, hose

18. Connect radiator hose (2) and charge air cooler hose (1) on upper side.

**Thank you very much
for your reading.**

**Please click here and go
back to the website.**

**Then, you can
download the complete
manual instantly.**

No waiting.

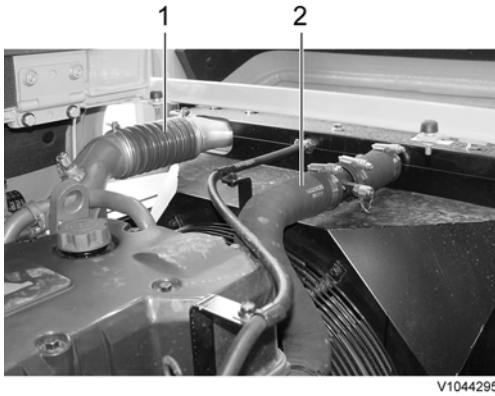

V1044295

Figure 14
Connect, hose

19. Install foot step (1).

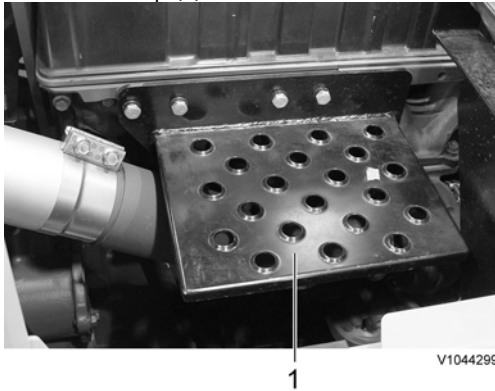

V1044299

Figure 15
Installation, foot step

20. Connect wire harness connector (2), hoses (3), and install expansion tank (1) with the bracket.

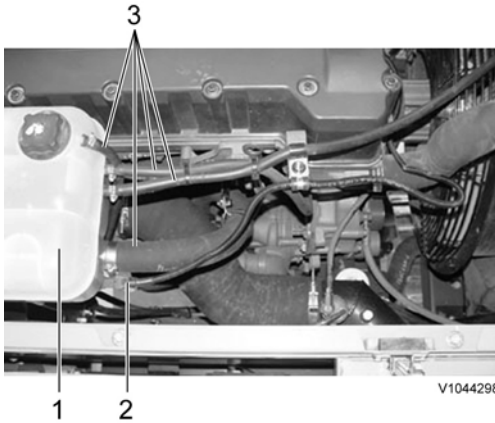

V1044298

Figure 16
Connect, wire harness and hose

21. Install the cowl using a lifting device.
22. Install the cowl mounting screws.
23. Install the engine rear cover.

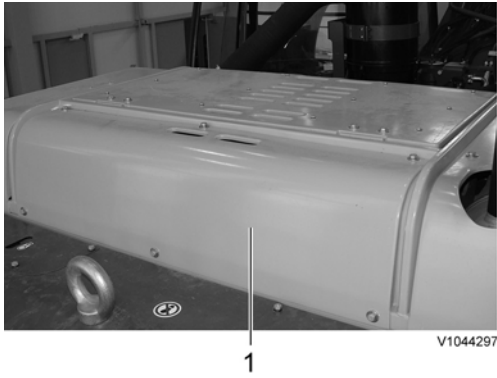

Figure 17
Installation, cover

24. Install screws (1) and open radiator hood (2).

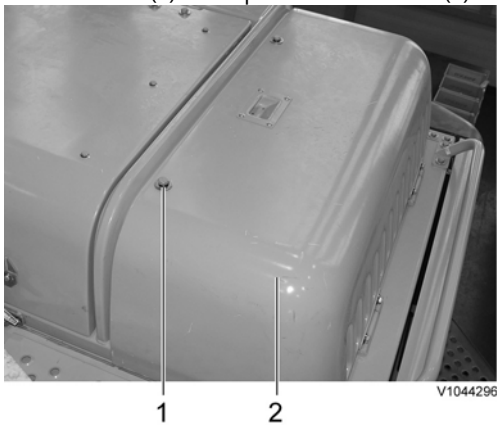

Figure 18
Installation, radiator hood

25. Install silencer hood (1).



Figure 19
Installation, silencer hood

26. Fill the hydraulic oil. See [173 Hydraulic system, changing oil](#)
27. Fill the coolant through the expansion tank. See [261 Coolant, changing](#)
28. Turn on the battery disconnect switch.
29. Start the engine and check for leaks and repair if needed.