

Document Title: <b>Engine, removing</b>	Function Group: <b>210</b>	Information Type: <b>Service Information</b>	Date: <b>2014/12/5</b>
Profile: <b>EXC, EC300D NL [GB]</b>			

## Engine, removing

Op nbr 210-070

### **! WARNING**

**Risk of burns - stop the diesel engine and allow it to cool down before starting any work.**

### **! WARNING**

**Removal of residual pressure from the circuit must be done prior to any maintenance.**

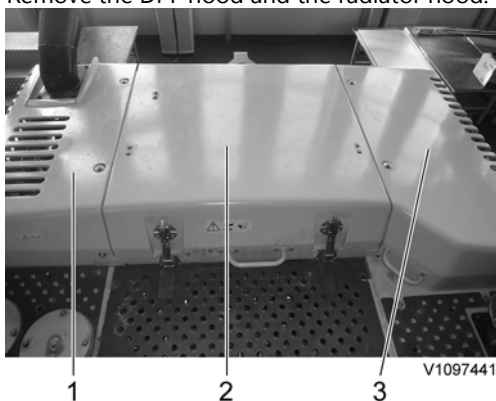
#### **NOTE!**

Cable ties and clamps that secure hoses and electrical wiring must be removed and then replaced when installing components.

#### **NOTE!**

Disconnected hoses, lines and connections must be plugged. Oil that drains from hoses, lines and connections should be collected in a container.

1. Place the machine in the service position B. See [091 Service positions](#)
2. Turn off the battery disconnect switch.
3. Drain the coolant in a collection container. See [261 Coolant changing](#).
4. Remove the DPF hood and the radiator hood.



**Figure 1**

1. DPF hood
  2. Engine hood
  3. Radiator hood
5. Remove the engine room cowl frame with the engine hood using a lifting device.



V1097442

**Figure 2**

6. Remove the air inlet hose and expansion tank hose.

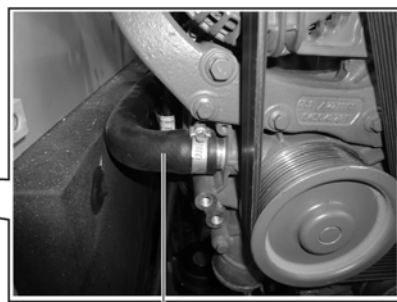
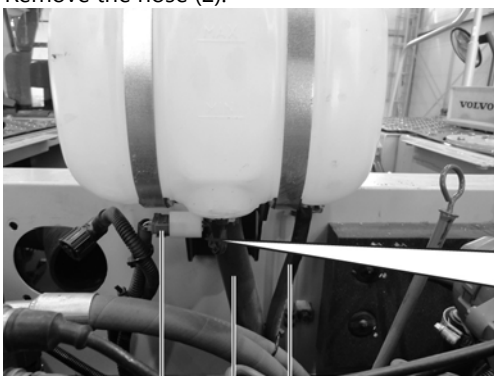


V1097487

**Figure 3**

1. Air inlet hose
2. Expansion tank hose

7. Disconnect wire harness connector and the hose (3) from the expansion tank.  
Remove the hose (2).

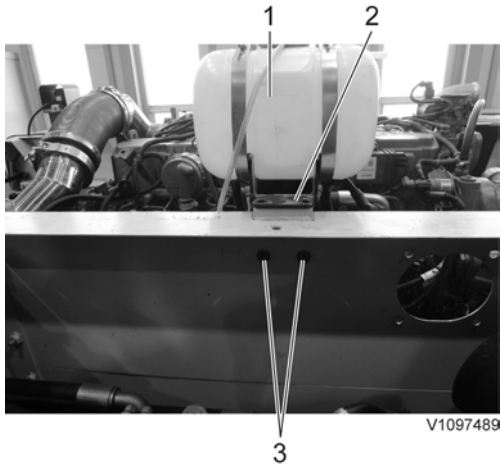


V1097488

**Figure 4**

1. Wire harness connector
2. Hose

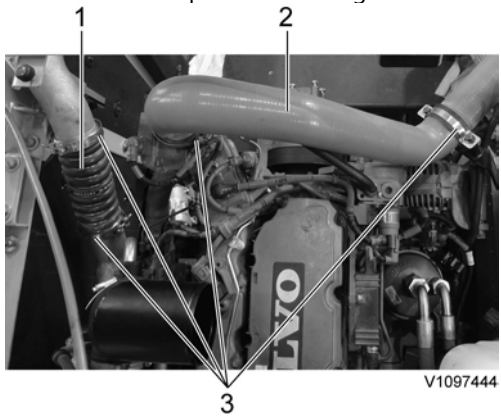
8. Remove the expansion tank with a bracket.



**Figure 5**

1. Coolant expansion tank
2. Bracket
3. Screw

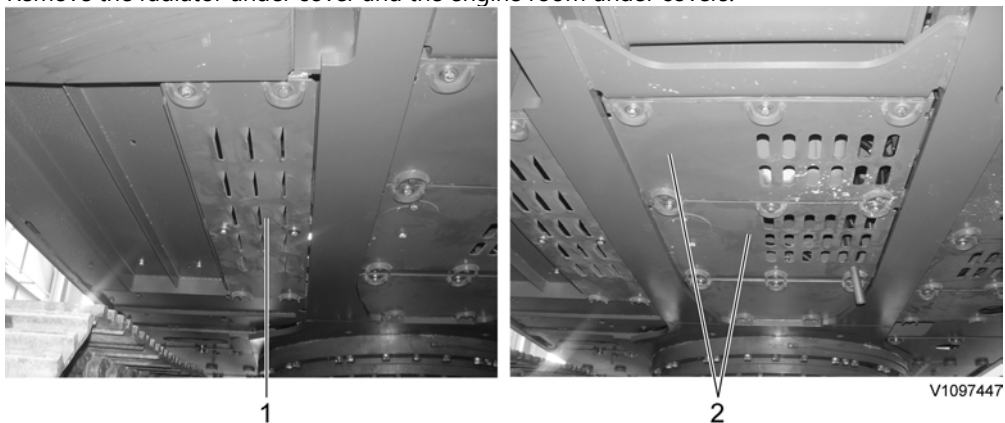
9. Remove the clamps and the charge air cooler tubes.



**Figure 6**

1. Charge air cooler tube (Outlet)
2. Charge air cooler tube (Inlet)
3. Clamp

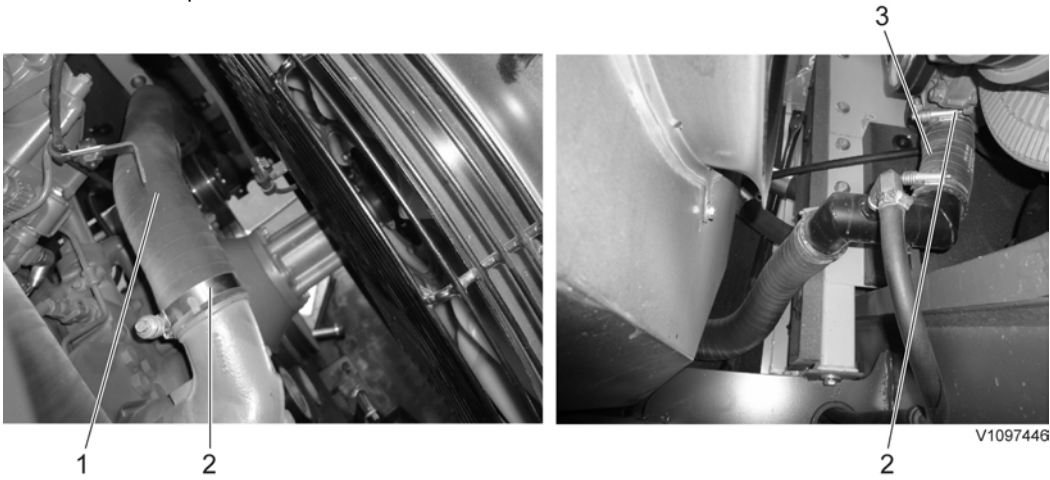
10. Remove the radiator under cover and the engine room under covers.



**Figure 7**

1. Radiator under cover
2. Engine room under cover

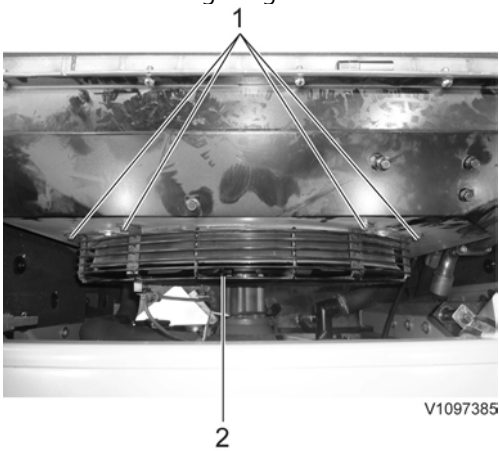
11. Remove the clamps and the radiator hoses.



**Figure 8**

1. Radiator hose (Inlet)
2. Clamp
3. Radiator hose (Outlet)

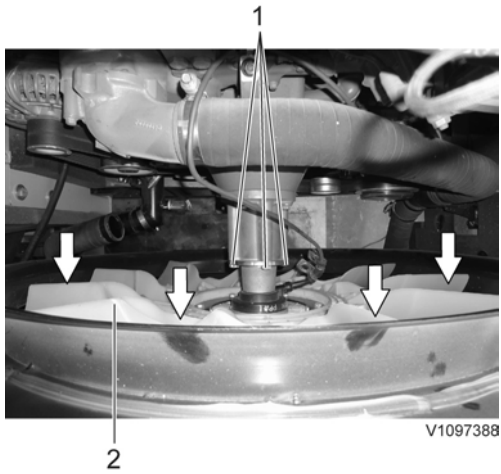
12. Remove the cooling fan guard.



**Figure 9**

1. Screw
2. Cooling fan guard

13. Remove the mounting screws and lay down the cooling fan inside the radiator shroud safely.



**Figure 10**

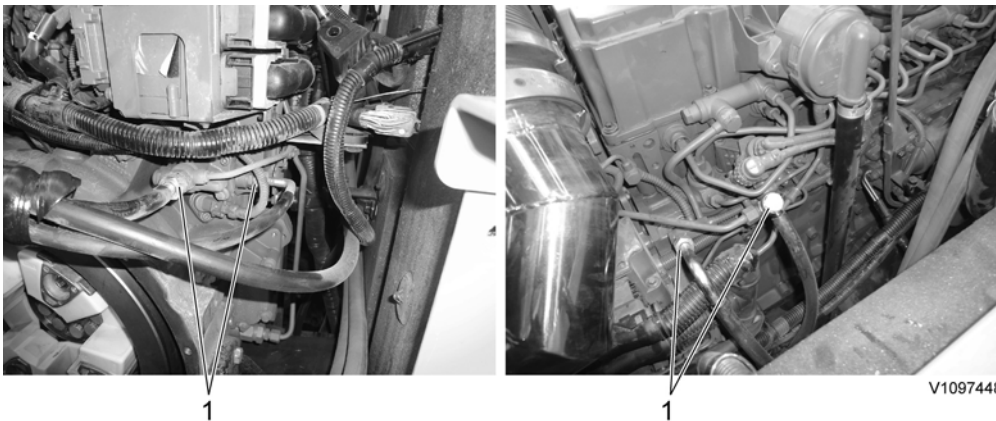
1. Screw
2. Cooling fan

14. Remove the main pump. See [913 Hydraulic pump, replacing](#)

15. Disconnect the fuel line hoses (4 pcs).

**NOTE!**

Ports must be plugged after disassembling hoses.



**Figure 11**

1. Fuel hose

16. Remove the air conditioner compressor belt.

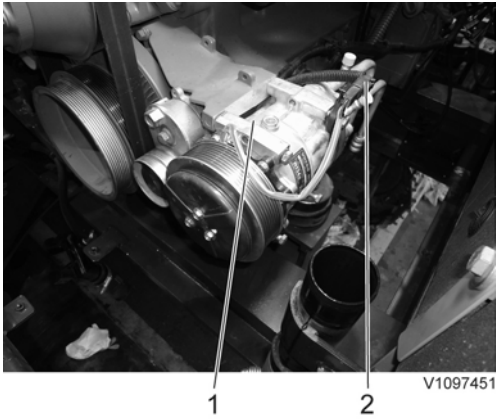


**Figure 12**

17. Disconnect the wire harness, remove the compressor and lay it down on the frame.



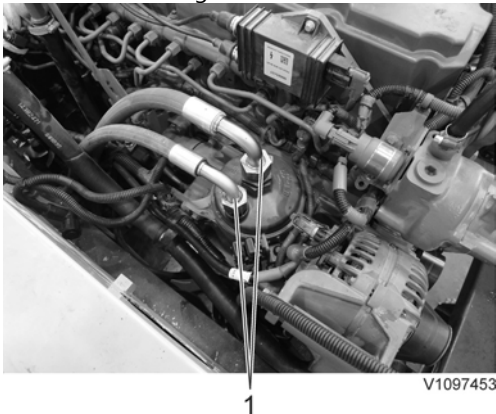
**Do not disconnect or loosen connections for the air conditioning unit (AC). Risk of gas leakage.**



**Figure 13**

1. Air conditioner compressor
2. Wire harness

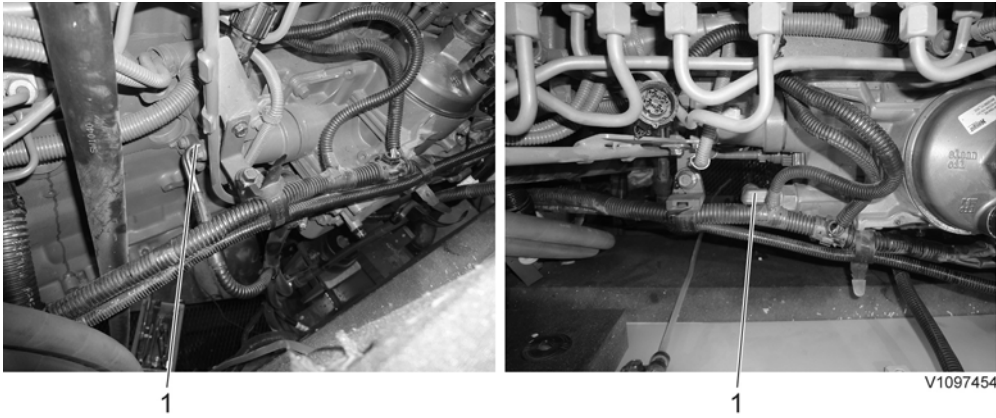
18. Disconnect the engine oil remote hoses.



**Figure 14**

1. Engine oil remote hose

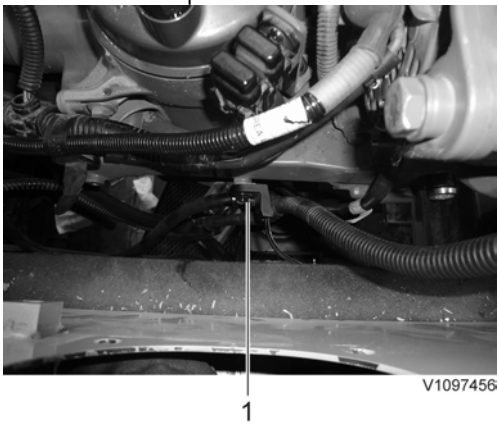
19. Disconnect the engine block heater wire-harness and the cab heater hose.



**Figure 15**

1. Engine block heater wire-harness (optional)
2. Cab heater hose (supply)

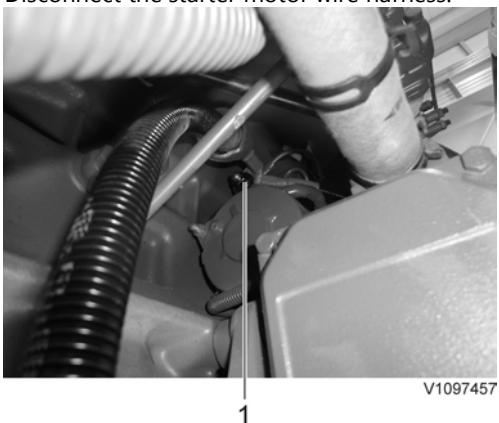
20. Remove the clamp



**Figure 16**

1. Clamp

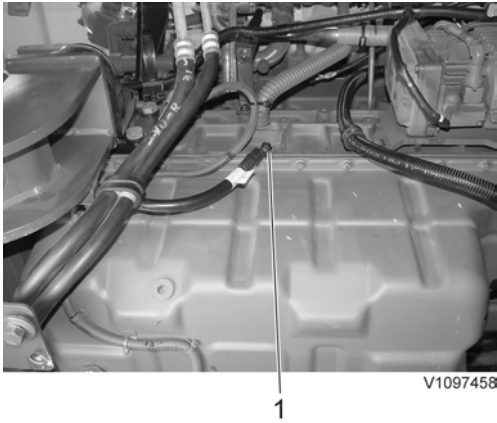
21. Disconnect the starter motor wire harness.



**Figure 17**

1. Starter motor wire harness

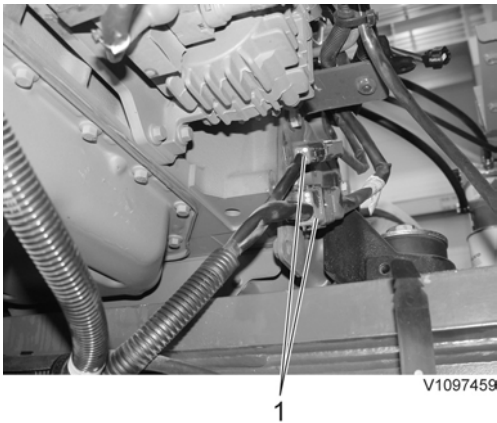
22. Disconnect the engine ground wire.



**Figure 18**

1. Ground wire

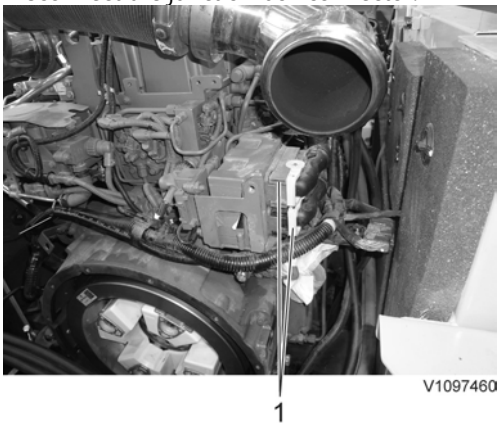
23. Remove the wire harness connectors.



**Figure 19**

1. Connector

24. Disconnect the junction box connector.

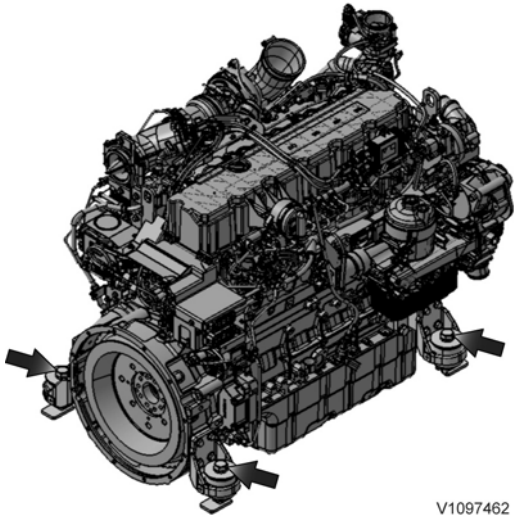


**Figure 20**

1. Junction box connector

25. Remove the four mounting screws.





V1097462

**Figure 21**

26. Lift the engine just a little using a lifting device, and after confirming safety around, lift it up and out slowly to the work stand.



V1097461

**Figure 22**

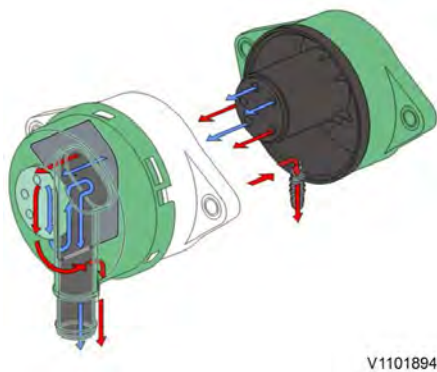
Document Title: <b>Crankcase ventilation, description</b>	Function Group: <b>212</b>	Information Type: <b>Service Information</b>	Date: <b>2014/12/5</b>
Profile: <b>EXC, EC300D NL [GB]</b>			

## Crankcase ventilation, description

Since some of the combustion pressure enters the crankcase after passing by the pistons and piston rings (blow-by), the crankcase must be ventilated.

The purpose of the crankcase ventilation is to balance the pressure in the crankcase in order to avoid damage to engine components and to prevent oil mist formation and oil leakage into the ambient air.

The crankcase ventilation consists of a housing containing a filter, with connections to the oil sump and ventilation piping.



**Figure 1**  
**Crankcase ventilation housing**

Air containing oil particles comes from the crankcase via the cylinder head into the crankcase ventilator. The air (blue arrows) passes through the filter, while oil particles (red arrows) are caught and led back to the oil sump via a return pipe.

### Supplementary information

- [200 Engine, description](#)
- [200 Component locations](#)

Document Title: <b>Valves, adjusting</b>	Function Group: <b>214</b>	Information Type: <b>Service Information</b>	Date: <b>2014/12/5</b>
Profile: <b>EXC, EC300D NL [GB]</b>			

## Valves, adjusting

Op nbr 214-012

[11668024 Rotation tool](#)

[885812 Timing tool](#)

### NOTE!

The engine must cool down for approx. 30 minutes and the oil temperature must not exceed 80°C (176°F)



### WARNING

**Risk of burns - stop the diesel engine and allow it to cool down before starting any work.**

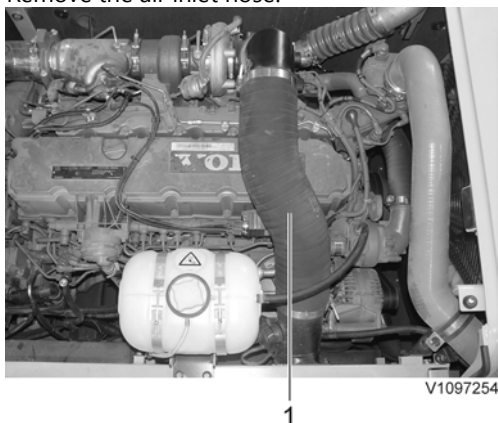
### NOTICE

**Never adjust the valves with the engine running as the valves may strike the piston and cause serious damage.**

### NOTICE

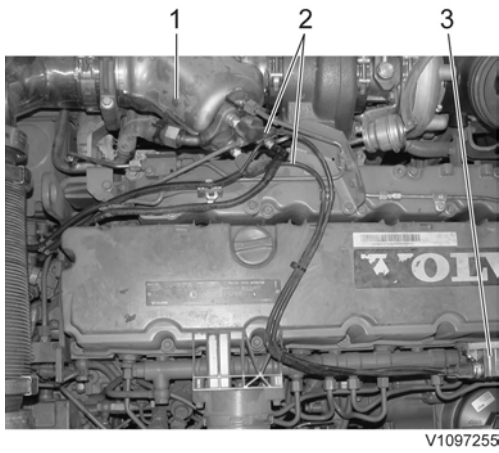
**Always cover open air connections with a plastic bag and rubber bands. Gravel, dust and other particles in these connections may result in engine failure!**

1. Place the machine in service position B. See [091 Service positions](#)
2. Open the engine hood.
3. Remove the air inlet hose.



**Figure 1**

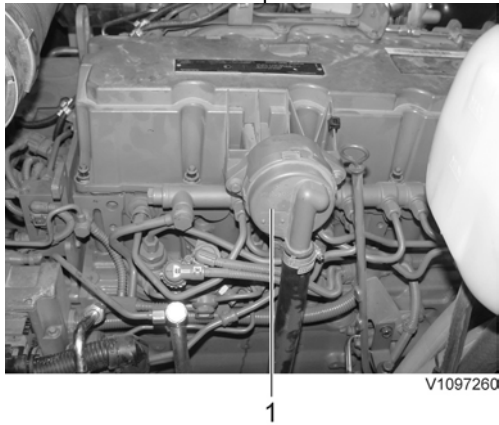
1. Air inlet hose
4. Cut the clamps and disconnect the ignition cables from the burner side.



**Figure 2**

1. Burner
2. Ignition cable
3. Spark plug control unit

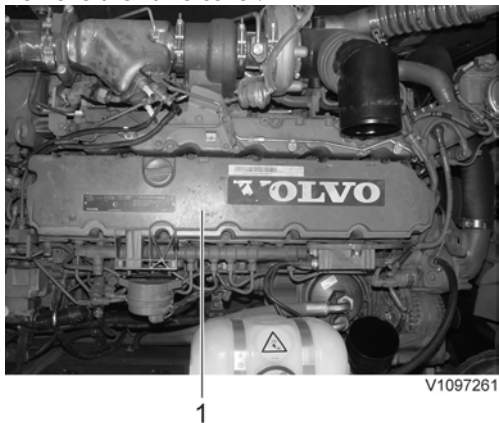
5. Remove the screws and put aside the crankcase ventilation duct from the engine.



**Figure 3**

1. Crankcase ventilation duct

6. Remove the valve cover.



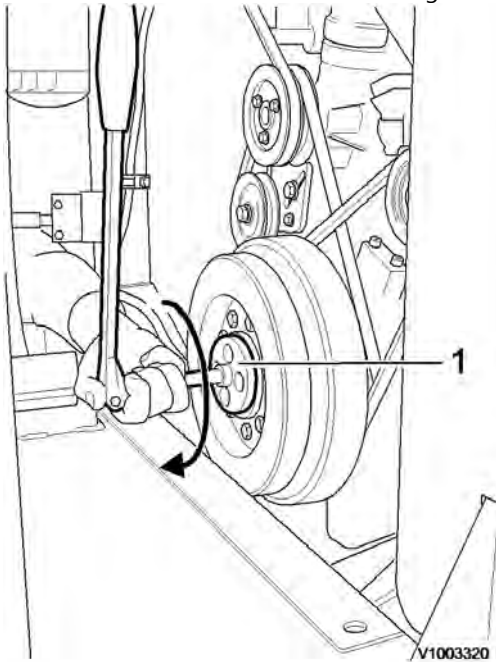
**Figure 4**

1. Valve cover

7. Remove the engine room under cover.

8. **Setting engine to valve overlap**

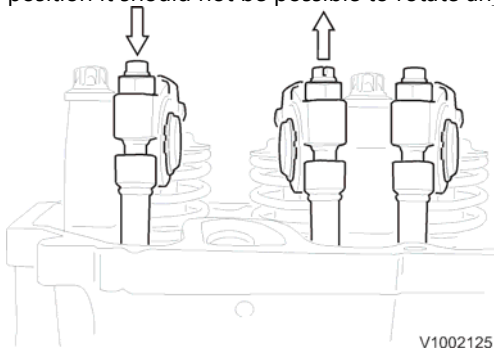
Place the rotation tool over the attaching bolts for the belt pulley.



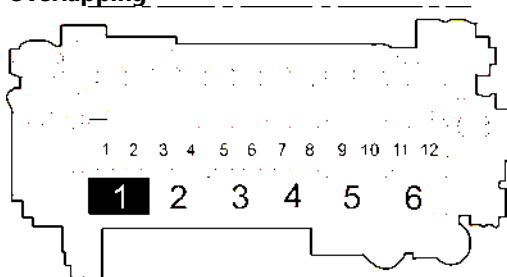
**Figure 5**  
**Placement of rotation tool (principle), direction of rotation**

- 1. 11668024 Rotation tool

9. Crank the engine, clockwise, to a position where the valves on the cylinder number 1 (**closest to the flywheel side**) overlap. Overlapping means that the exhaust valve is about to open and the inlet valve is about to close. In this position it should not be possible to rotate any of the push rods by hand for the cylinder in question.



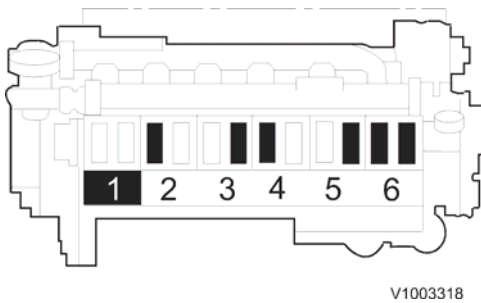
**Figure 6**  
**Overlapping**



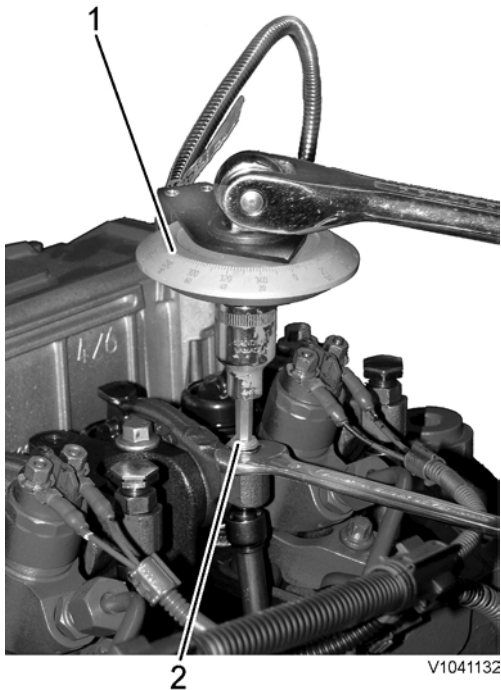
**Figure 7**

- 1, 3, 5, 7, 9, 11 are exhaust valves  
2, 4, 6, 8, 10, 12 are inlet valves

10. Mark the position on the belt pulley and oil pump's cover.
11. Adjust the valve clearance for each cylinder according to **the black markings** in the figure. Procedure for adjusting:
1. Loosen the adjusting screw's lock screw on the rocker arm.
  2. Install the timing tool on the adjusting screw.
  3. Turn the adjusting screw until zero clearance is obtained between rocker arm and valve. Set the timing tool to zero.
  4. Turn the adjusting screw **counter-clockwise  $75^\circ \pm 10^\circ$  for inlet valve** and  **$105^\circ \pm 10^\circ$  for exhaust valve**. see [214 Valve system, specification](#).
  5. Hold the adjusting screw in position and at the same time tighten the lock nut. Tightening torque: See [210 Engine, tighten torques](#)

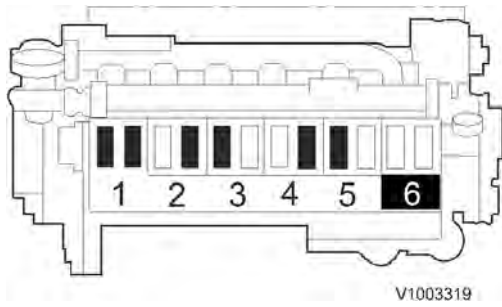


**Figure 8**



**Figure 9**  
**Use of timing tool**

1. 885812 Timing tool
  2. Adjusting screw
12. Turn the crankshaft one more revolution until the valves for cylinder number 6 overlap. Adjust the valve clearance for each cylinder according to **the black markings** in the figure.



**Figure 10**

13. Install the valve cover. Tightening torque, see [210 Engine, tighten torques](#).

### **Assembly**

14. For assembly, reverse disassembly procedure.

**NOTE!**

Do not reuse the O-rings and gasket.

15. After the completion of the work, start the engine and check for leaks and operating condition.

Document Title: <b>Oil level sensor, changing</b>	Function Group: <b>217</b>	Information Type: <b>Service Information</b>	Date: <b>2014/12/5</b>
Profile: <b>EXC, EC300D NL [GB]</b>			

## Oil level sensor, changing

Op nbr 217-005

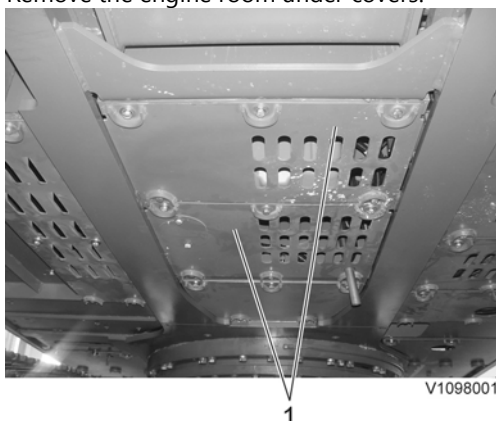


**Risk of burns - stop the diesel engine and allow it to cool down before starting any work.**

### NOTE!

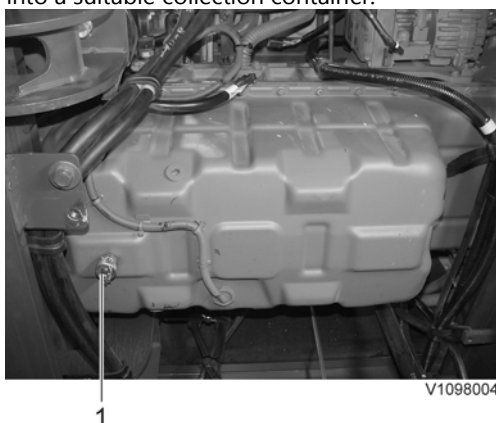
Cable ties and clamps that secure hoses and electrical wiring must be removed and then replaced when installing.

1. Place the machine in the service position B. See [091 Service positions](#)
2. Turn the battery disconnect switch to off position.
3. Remove the engine room under covers.



**Figure 1**

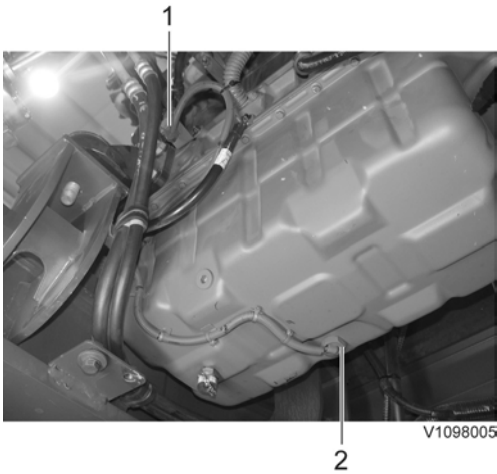
1. Engine room under cover
4. Open the oil drain valve cap and install the engine oil drain hose and then allow the oil to drain from the engine into a suitable collection container.





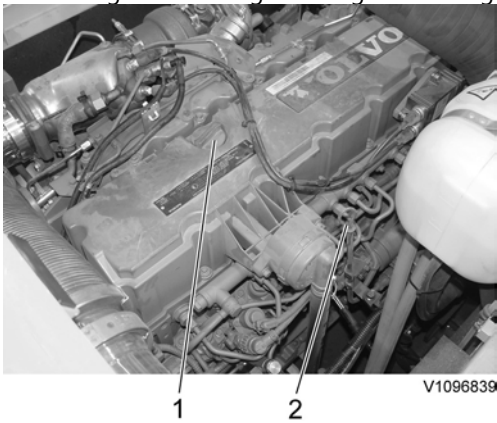
**Figure 2**

1. Engine oil drain valve cap
5. Disconnect wire harness connector and then remove all clamps and ties.



**Figure 3**

1. Wire harness connector
2. Oil level sensor
6. Remove the oil level sensor and replace it as a new one.
7. Restore the machine to operating condition.
8. Fill the engine oil through the engine oil filling port



**Figure 4**

1. Engine oil filling port cap
2. Dipstick gauge

**NOTE!**

Engine Oil capacity: see [030 Specification, filling capacities](#).

9. Set the ignition switch to "ON" position and check the oil level on the I-ECU.

**Thank you very much for reading.**

**This is part of the demo page.**

**GET MORE:**

**Hydraulic**

**System, Setting**

**Instructions, Functional**

**Description, Electrical**

**System And more.....**

**Click Here BUY NOW**

**Then Instant Download**

**the Complete Manual.**