

Document Title: Lubrication oil pressure, checking with pressure gauge	Function Group: 221	Information Type: Service Information	Date: 2014/10/31
Profile: EXC, EC290C LR [GB]			

Lubrication oil pressure, checking with pressure gauge

Op nbr 221-022

[11666037 Hose](#)

[11666017 Pressure gauge](#)

[936444 Testing nipple](#)

1. Place the machine in service position B, see [091 Service positions](#).



WARNING

Risk of burns! Use protective work gloves.

2. Turn the battery disconnect switch to off position.
3. Open the engine hood.
4. • Remove the oil pressure switch on the oil filter head and install a measuring nipple.

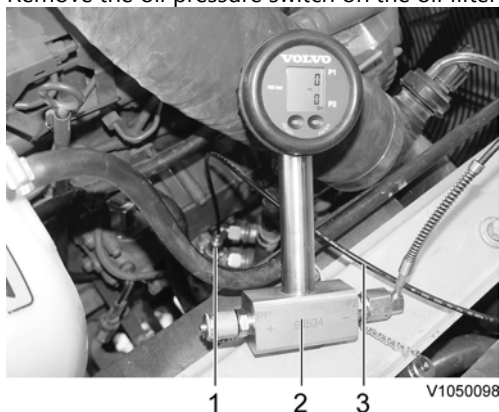

Figure 1

1. 13933251 Measuring nipple M14x1.5
2. 11666017 Pressure gauge
3. 11666037 Hose

- Connect the hose and pressure gauge.
- Start the engine and warm up to operating temperature. At high idle, the oil pressure should be according to [030 Lubrication system, specifications](#)

NOTE!

Use the new cooper washer when installing.

Document Title: Oil cooler, replacing	Function Group: 223	Information Type: Service Information	Date: 2014/10/31
Profile: EXC, EC290C LR [GB]			

Oil cooler, replacing

Op nbr 223-006

1. Place the machine in service position, see [091 Service positions](#).
2. Open the engine hood.
3. Drain the coolant from the engine, see [261 Coolant changing](#).
4. Remove mounting screws (1), (2) on the clamps.

NOTE!

Approach from the front side when removing screw (1).

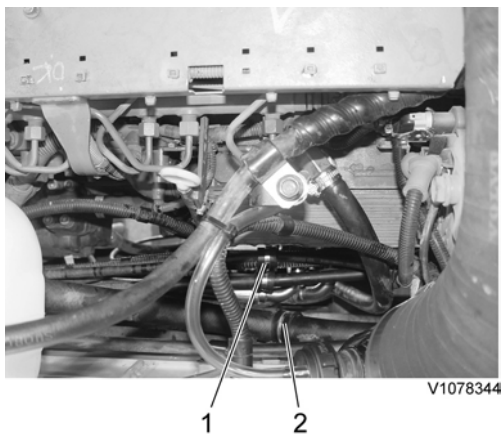

Figure 1

5. Remove mounting screws on clamps (1) and disconnect hose (2)..

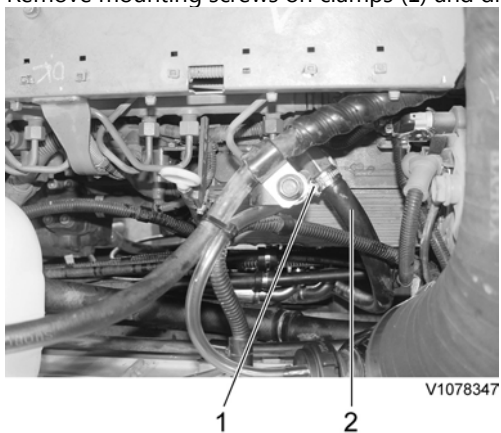
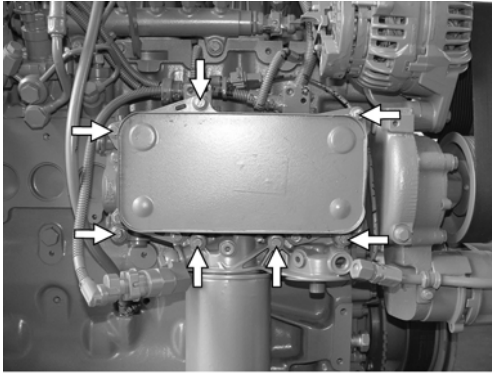

Figure 2

6. Remove all screws for the oil cooler.

NOTE!

Tightening torque: 22 ±2 Nm (2.2 ±0.2 kgfm) (16.3 ±1.5 lbf ft)



V1076672

Figure 3

7. Remove the oil cooler from the engine block.

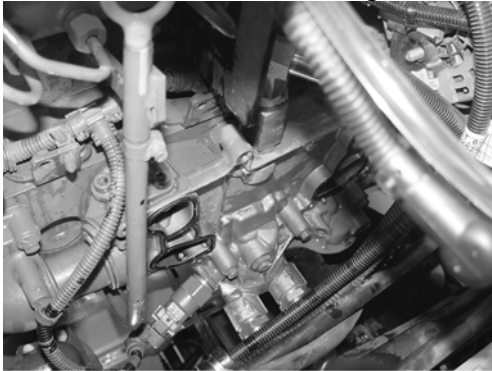

V1078348

Figure 4

8. Clean all sealing surfaces.
9. Fit a new oil cooler on the engine block, use new seal gaskets.

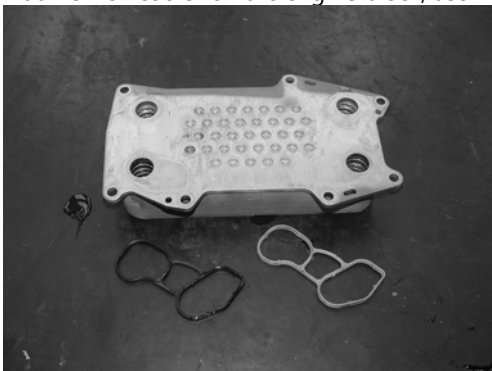

V1076673

Figure 5

10. For assembling, reverse disassembly procedure.
11. Fill coolant in the cooling system.
12. Start, run the engine until warm, check for leaks.
If needed, adjust the coolant level in the cooling system.

Document Title: Fuel system, description	Function Group: 230	Information Type: Service Information	Date: 2014/10/31
Profile: EXC, EC290C LR [GB]			

Fuel system, description

The engines use a pressure accumulator system known as common-rail fuel injection.

The main advantage of the common-rail system is its ability to vary injection pressure and timing over a broad scale. This is made possible by separating the functions of pressure generation and fuel injection.

The fuel delivery system is made up of a low pressure and high pressure circuit.

The low pressure supply circuit consists of a fuel tank, water separator filter, belt driven fuel transfer pump, secondary fuel filter and FCU (Fuel Control Unit).

The high pressure circuit consists of two high pressure pumps driven by the engine camshaft, a pressure-accumulator (fuel rail), high pressure lines, high fuel pressure (fuel rail pressure) sensor and electronically controlled fuel injectors.

The transfer pump in the low pressure circuit draws fuel from the tank, through a water separator filter and into the pump inlet. Fuel is then forced from the pump through the secondary filter to the FCU (Fuel Control Unit) at the inlet of the high pressure pumps.

The FCU controls filling of the high pressure pumps so as to maintain the rail pressure set point.

The continuously operating high pressure fuel pumps produce the desired injection pressure that is stored in the pressure accumulator (fuel rail).

High pressure fuel from the pressure accumulator is available to the injectors at all times. The electronic fuel injectors control injection timing and quantity.

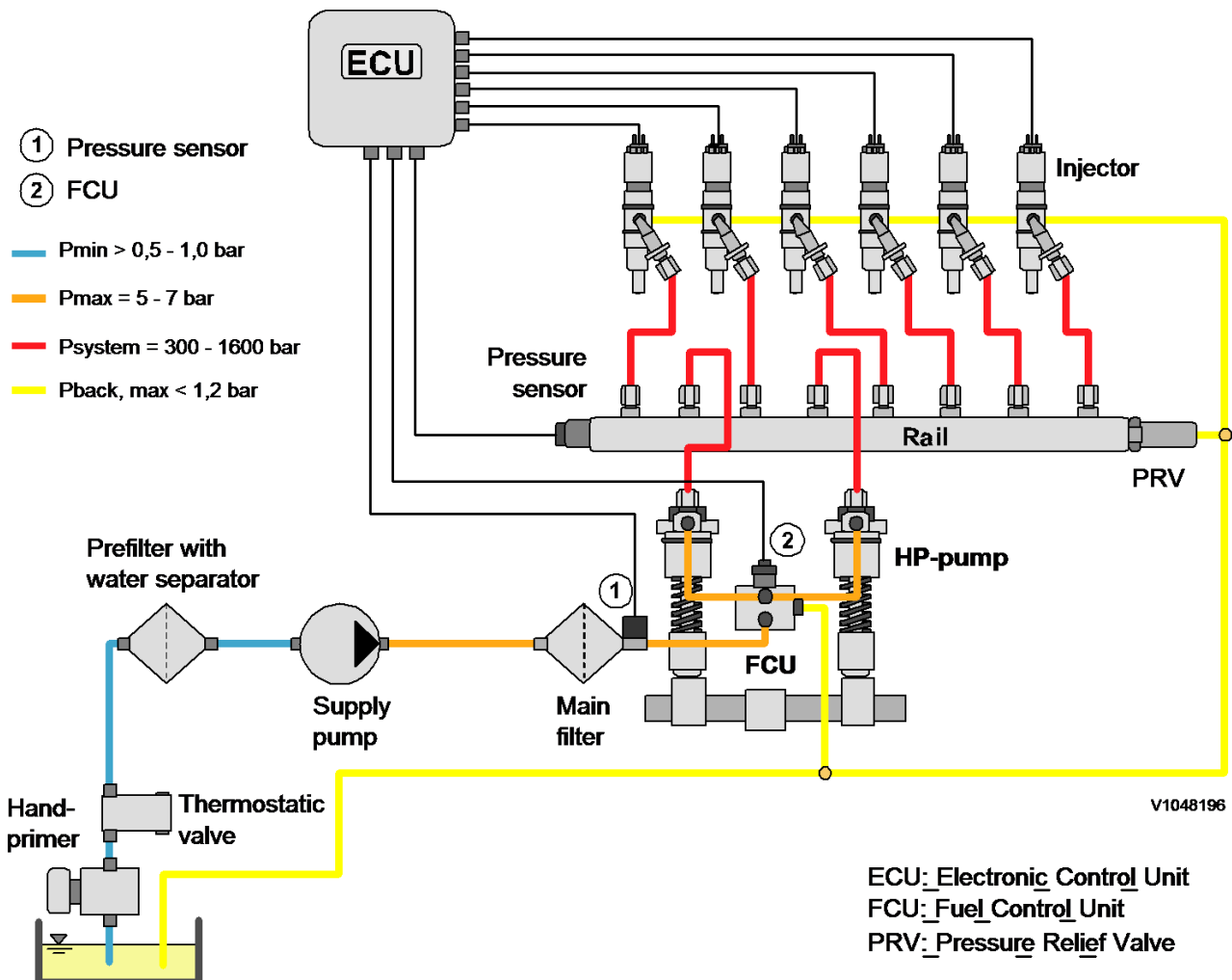

Figure 1
Fuel system

Document Title: Instructions for working with electronic fuel injection	Function Group: 230	Information Type: Service Information	Date: 2014/10/31
Profile: EXC, EC290C LR [GB]			

Instructions for working with electronic fuel injection

- Never disconnect any cables from the control unit or from the sensors, when the engine is running. The ignition key must be in position 0 and the engine stopped.
- Never disconnect a battery cable while the engine is running.
- Before carrying out welding work, the control unit connectors must be disconnected from the control unit.
NOTE!
The main current supply must be switched off when the connectors are disconnected.
- Only batteries must be used as starting aid. Starting aid units may supply overvoltage and damage the electronics.
- During rapid charging of the batteries, the battery cables must be disconnected. (This does not apply during normal trickle charging.)
- If a connector has been disconnected, make sure it is correctly reconnected, and that it is completely free from oil or other contamination, which may cause a poor contact.

Document Title: Carbon monoxide in fuel system, check	Function Group: 230	Information Type: Service Information	Date: 2014/10/31
Profile: EXC, EC290C LR [GB]			

Carbon monoxide in fuel system, check

Carbon monoxide in fuel tank, check with carbon monoxide tester

Op nbr 230-001

[9808038 Leak detector](#)

1. Run the engine until it is warm.
2. Dismantle 9808038 Leak detector.
Lubricate the O-rings with silicone grease or clean vaseline.
3. Fill both chambers with reaction fluid up to the indicated line.
4. Cover the inlet hole at the same time as the carbon monoxide tester is assembled so that no fluid is pressed out.
NOTE!
The carbon monoxide tester and its fluids may not be exposed to cigarette smoke, exhausts, or similar.
Conduct the test on a machine that is not recently refuelled.
5. Rev up the engine several times.
6. Turn off the engine and open the tank cap.
Place 9808038 Leak detector over the tank opening and pump 3–5 times on the rubber bulb to suck in air from the tank. Wait 10–15 seconds to see if the reaction fluid reacts.
NOTE!
Fuel may not be sucked into the carbon monoxide tester.
If the reaction fluid in 9808038 Leak detector changes colour, this indicates that there is carbon monoxide in the tank.
Very small quantities of carbon monoxide are often present in the machine's systems, that is why the measurement should be repeated if the first measurement generates a reaction.
7. Suck fresh air into 9808038 Leak detector by pumping a few times on the bulb. Pump until the reaction fluid has returned to its original colour.
8. Ventilate the air above the filler hole to the tank and repeat the test.
NOTE!
Do not blow with exhaled air as it contain carbon dioxide.
9. Reinstall the tank cap.

Document Title: Fuel feed pump, description	Function Group: 233	Information Type: Service Information	Date: 2014/10/31
Profile: EXC, EC290C LR [GB]			

Fuel feed pump, description

The fuel feed pump is designed as a rotor pump and is driven by a Vee-belt.

The non-return valve (2) prevents the fuel from draining back to the tank. This facilitates re-starting the engine.

If the fuel lines have been run dry of fuel, the fuel system should be filled and bled with the hand pump located on the primary filter housing. The non-return valve (2) opens and allows fuel to circulate in the entire circuit. In this way, the unit pumps are supplied with fuel free from air.

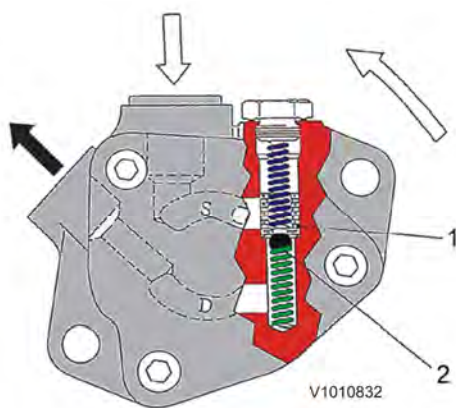

Figure 1

Document Title: Feed pump, checking feed pressure	Function Group: 233	Information Type: Service Information	Date: 2014/10/31
Profile: EXC, EC290C LR [GB]			

Feed pump, checking feed pressure

Op nbr 233-004

[9993720 Nipple](#)

[11666052 Pressure gauge](#)

[14290262 Adapter](#)

[14290266 Hose](#)

1. Remove the banjo bolt assembled to the fuel filter and install adapter (1), nipple (2), hose (3) and pressure gauge (4) to the fuel pressure side connection.

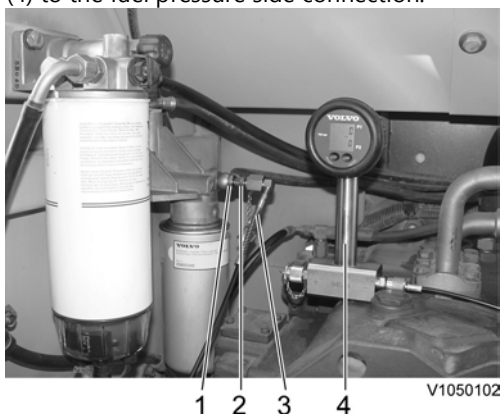

Figure 1

1. 14290262 Adapter
 2. 9993720 Nipple
 3. 14290266 Hose
 4. 11666052 Pressure gauge
2. Bleed the fuel system according to [233 Fuel system, bleeding](#).
 3. Read the fuel feed pressure and check that it is according to [030 Fuel feed pump, specifications](#)
If the measured pressure is too low:
Connect the gauge to the fuel supply connection (5). Bleed the fuel system according to [233 Fuel system, bleeding](#)
Read off the fuel feed pressure. If the pressure is according to [030 Fuel feed pump, specifications](#), the fuel filter may be clogged. Change filter and check the fuel feed pressure again on the outgoing fuel pressure line according to step 1-2.
If the pressure still is too low, it may be due to a defective overflow valve, fuel pump or fuel supply. Check the fuel feed pump and that the fuel supply line is not clogged or has an air leak.
 4. Remove adapter (1), nipple (2), hose (3) and pressure gauge (4), and install the banjo bolt at the fuel filter.
 5. Bleed the fuel system according to [233 Fuel system, bleeding](#).

Document Title: Fuel pump, inspection	Function Group: 233	Information Type: Service Information	Date: 2014/10/31
Profile: EXC, EC290C LR [GB]			

Fuel pump, inspection

Op nbr 233-010

NOTE! Take care of fuel spills by using collection containers.

1. Place the machine in the service position B. See [091 Service positions](#)
2. Open the engine hood.
3. Turn belt tensioner (2) clockwise using a socket handle (1/2"), and remove alternator belt (1) from alternator (3) and the tensioner pulley.

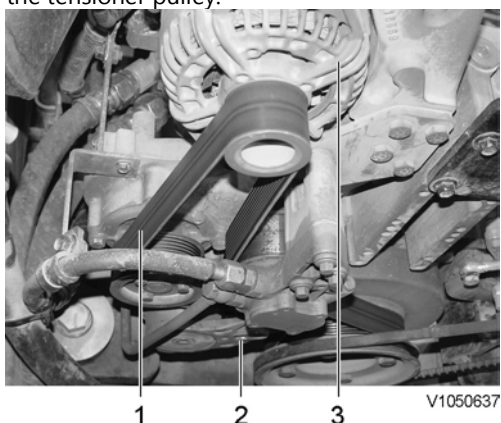

Figure 1

1. Alternator belt
2. Belt tensioner (socket handle installation position)
3. Alternator

NOTE!

The belt adjuster tension is very strong. Therefore pay attention to prevent injury after removing belt.

4. Remove hose (1), pipe (2), screws (4) and fuel feed pump (3).

NOTE!

Cover the ends of the hoses to prevent contamination from entering the fuel system.

NOTE!

Pay attention not to drop any fuel on the belt when removing the fuel feed pump.

Thank you very much for reading.

This is part of the demo page.

GET MORE:

Hydraulic

System, Setting

Instructions, Functional

Description, Electrical

System And more.....

Click Here BUY NOW

Then Instant Download

the Complete Manual.