



3,6, 8 & 9 Series Rotary Cutters



JOHN DEERE

TECHNICAL MANUAL

3,6, 8 & 9 Series
Rotary Cutters

TM1394 (01MAY87) English

John Deere Welland Works
TM1394 (01MAY87)

LITHO IN U.S.A.
ENGLISH

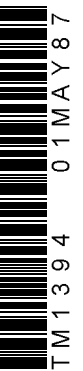

3, 6, 8 AND 9 SERIES ROTARY CUTTERS TECHNICAL MANUAL TM-1394 (MAY 87)

SECTION AND GROUP CONTENTS

SECTION 10—SAFETY AND SPECIFICATIONS

- Group 05—Introduction and Safety Information
- Group 10—General Specifications
- Group 15—Hardware Torque
- Group 20—Lubrication
- Group 30—Serial Numbers

SECTION 20—DRIVELINE REPAIR

- Group 05—Specifications
- Group 10—Driveline Repair
- Group 15—Driveline Shield Repair

SECTION 30—CLUTCH AND SHEAR DEVICE REPAIR

- Group 05—Shear Device Repair
- Group 10—Slip Clutch Repair

SECTION 40—GEAR CASE REPAIR

- Group 00—General Information
- Group 05—3 Series Gear Case Repair
- Group 10—6 Series Gear Case Repair
- Group 15—8 Series Outer and 9 Series Gear Case Repair
- Group 20—1008 Integral or Center Pull-Type Center Gear Case Repair
- Group 25—1008 Offset Pull-Type, Left-Hand Gear Case Repair
- Group 30—1408, 1418 Center Gear Case Repair
- Group 35—1508 Center Gear Case Repair

SECTION 50—MISCELLANEOUS REPAIR

- Group 05—Blades
- Group 10—Blade Holders
- Group 15—1408 Frame Replacement

All information, illustrations and specifications contained in this technical manual are based on the latest information available at the time of publication. The right is reserved to make changes at any time without notice.

COPYRIGHT© 1987
DEERE & COMPANY
Moline, Illinois
All rights reserved
A JOHN DEERE ILLUSTRATION

W11;0000 -A 090687

Section 10 GENERAL INFORMATION

CONTENTS

Page

GROUP 05—Introduction And Safety

Introduction 10-05-1

Safety 10-05-2

GROUP 10—General Specifications

Specifications

403, 503 Rotary Cutter 10-10-1

506, 606 Rotary Cutter 10-10-2

509, 609, 709 Rotary Cutter 10-10-4

1008 Rotary Cutter 10-10-6

1418, 1508 Rotary Cutter 10-10-8

SAFETY AND YOU

This is the safety-alert symbol. When you see this symbol on the machine or in this manual, be alert to the potential for personal injury.

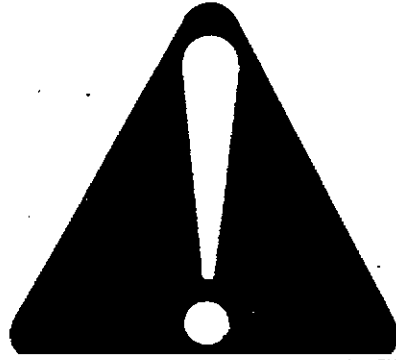

AB6;T81389 053;TMSAFE 071085

PREPARE FOR EMERGENCIES

Be prepared if a fire starts.

Keep a first aid kit and fire extinguishers handy.

Keep emergency numbers for doctors, ambulance service, hospital, and fire department near your telephone.

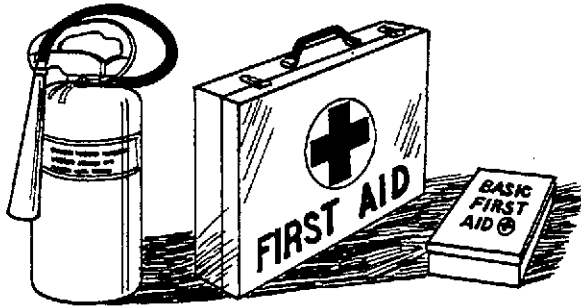

AB6;TS186 053;FIRE2 080785

STAY CLEAR OF PTO

Entanglement in rotating driveline can cause serious injury or death.

Keep tractor master shield and driveline shields in place at all times except for special applications as directed in the implement operator's manual.

Wear fairly tight fitting clothing. Stop the engine and be sure PTO driveline is stopped before making adjustments, connections, or cleaning out PTO driven equipment.



AB6;TS198 053;PTO 280186

WEAR PROTECTIVE CLOTHING

Wear fairly tight clothing. and safety equipment.

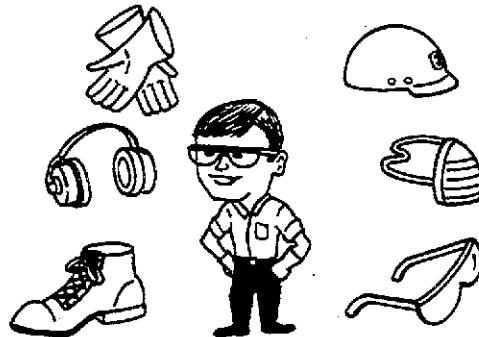

AB6;TS184 053;WEAR2 080785

PROTECT AGAINST NOISE

Prolonged exposure to loud noise can cause impairment or loss of hearing.

Wear a suitable hearing protective device such as earmuffs (A) or earplugs (B) to protect against objectionable or uncomfortable loud noises.

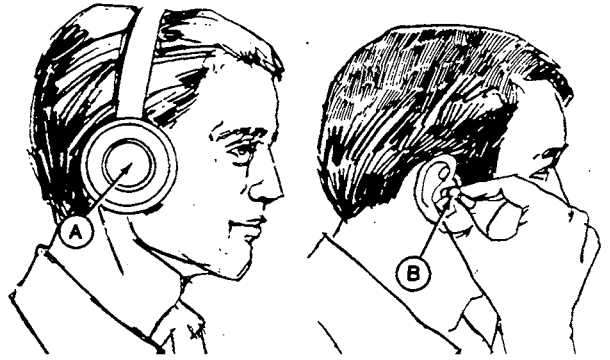

AB6;X7662 053;NOISE 270886

AVOID HIGH-PRESSURE FLUIDS

Escaping fluid under pressure can penetrate the skin causing serious injury. Relieve pressure before disconnecting hydraulic or other lines. Tighten all connections before applying pressure. Keep hands and body away from pinholes and nozzles which eject fluids under high pressure. Use a piece of cardboard or paper to search for leaks.

If ANY fluid is injected into the skin, it must be surgically removed within a few hours by a doctor familiar with this type injury or gangrene may result.

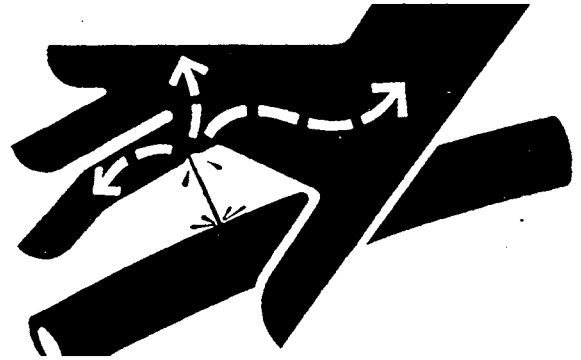

AB6;X9811 053;FLUID. 290186

OPERATE CUTTER SAFELY

This machine should not be used in areas where bystanders may be present and could be injured, or property could be damaged by thrown objects. Debris can be thrown hundreds of feet. Be sure cutter is equipped with front and rear safety shields.

Operate cutter from tractor operating station only.

Do not allow riders on cutter or tractor.

Avoid holes when operating on hillsides. Tractor roll-over could result.

Components behind shields may rotate several minutes after power is shut off. Look and listen for evidence of rotation before removing shielding.

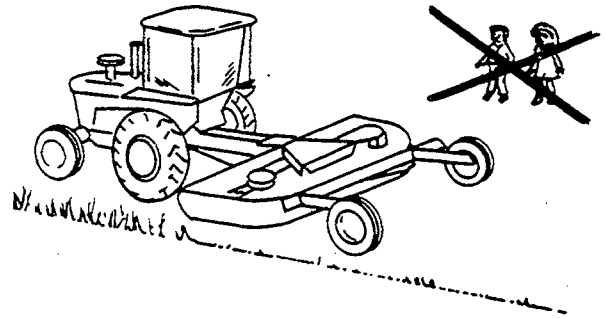

6DA;W11127 W11;1005 -A 020387

PRACTICE SAFE MAINTENANCE

The blades and blade holder may rotate for several minutes after PTO is shut off. Look and listen for rotating driveline to stop before working on the cutter.

When servicing blades or blade holder, it will be necessary to work underneath cutter. Be sure to support cutter frame with safety stands to prevent accidental lowering. Do not position safety stands under axle or wheel supports because these components can rotate.

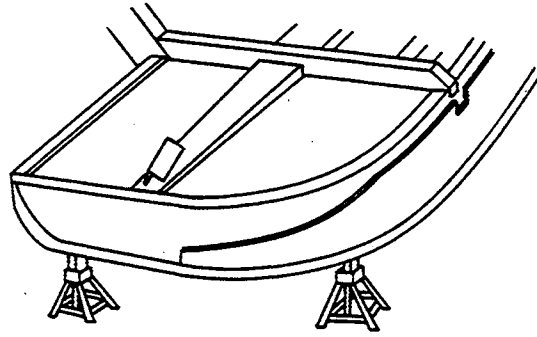

5DA;W12803 W01;;14SY E 270187

KEEP SERVICE AREA CLEAN

Keep the service area clean and dry; wet or oily floors are slippery. Wet spots can be dangerous when working with electrical equipment.

Be sure all electrical outlets and tools are properly grounded.

Use adequate light for the job at hand.



5EA;W9966 W02;;1010 E. 050886

BUY NOW

**Then Instant Download
the Complete Manual
Thank you very much!**