

Service Manual

Fastrac

**2115, 2125, 2135,
2140, 2150**

From Serial No 0738000

3155, 3185

From Serial No 0640000

Published by the
TECHNICAL PUBLICATIONS DEPARTMENT
of
JCB SERVICE LTD;
World Parts Centre,
Waterloo Park
Uttoxeter, Staffordshire
ST14 7BS

Publication No. 9803/8020
Issue 17

General Information	1
Care & Safety	2
Routine Maintenance	3
Optional Equipment	A
Body & Framework	B
Electrics	C
Controls	D
Hydraulics	E
Transmission	F
Brakes	G
Steering	H
Suspension	S
Engine	T

Introduction

This publication is designed for the benefit of JCB Distributor Service Engineers who are receiving, or have received, training by JCB Technical Training Department.

These personnel should have a sound knowledge of workshop practice, safety procedures, and general techniques associated with the maintenance and repair of hydraulic earthmoving equipment.

Renewal of oil seals, gaskets, etc., and any component showing obvious signs of wear or damage is expected as a matter of course. It is expected that components will be cleaned and lubricated where appropriate, and that any opened hose or pipe connections will be blanked to prevent excessive loss of hydraulic fluid and ingress of dirt. Finally, please remember above all else

SAFETY MUST COME FIRST!

The manual is compiled in sections, the first three are numbered and contain information as follows:

- 1 = General Information** - includes torque settings and service tools.
- 2 = Care & Safety** - includes warnings and cautions pertinent to aspects of workshop procedures etc.
- 3 = Routine Maintenance** - includes service schedules and recommended lubricants for the whole machine.

The remaining sections are alphabetically coded and deal with Dismantling, Overhaul etc. of specific components, for example:

- A = Optional Equipment**
- B = Body & Framework ...etc**

The page numbering in each alphabetically coded section is not continuous. This allows for the insertion of new items in later issues of the manual.

Section contents, technical data, circuit descriptions, operation descriptions etc. are inserted at the beginning of each alphabetically coded section.

All sections are listed on the front cover; tabbed divider cards align directly with individual sections on the front cover for rapid reference.

Page cross references are generally made by presenting the subject title printed in bold, followed by the title of the section containing the subject. For example:

“**24** If the axle is still on the machine, fit the brake calipers (see **Brake Caliper Removal and Replacement**, Section G).”

Note: If only the subject title in bold is given, i.e. no section title, the cross reference is to another part of the same section.

Use the contents list at the beginning of each section to find the exact page number.

Where a torque setting is given as a single figure it may be varied by plus or minus 3%. Torque figures indicated are for dry threads, hence for lubricated threads may be reduced by one third.

‘Left Hand’ and ‘Right Hand’ are as viewed from the rear of the machine facing forwards.

Contents	Page No.
Machine Identification Plate	1 - 1
Typical Vehicle Identification Number (VIN)	1 - 1
Typical Engine Identification Number	1 - 1
Unit Identification	1 - 1
Torque Settings	
Introduction - Zinc Plated Fasteners and Dacromet Fasteners	2 - 1
Zinc Plated Fasteners	2 - 2
Dacromet Fasteners	2 - 3 to 2 - 6
Sealing and Retaining Compounds	3 - 1
Service Tools Numerical List	4 - 1
* Service Tools	
Body and Framework	5 - 1
Electrics	6 - 1
Hydraulics	7 - 1
Transmission	8 - 1
Brakes	9 - 1
Steering	9 - 1
Suspension	9 - 2
Engine	9 - 2
Moving a Disabled Machine	
General	10 - 1
Preparation for Towing	10 - 1
Transporting the Machine	10 - 2

Machine Identification Plate

Each machine has an identification plate located at **X**. The Vehicle Identification Number (VIN), and the serial numbers of the engine and transmission are stamped on the plate.

Typical Vehicle Identification No. (VIN)



A = Manufacturing Code

B = Machine Range

* **C** = Engine Code:

- 07 = 1006-6T4
- 10 = 6BTA
- 13 = New 1000 Series, Rating 1941/2300 (2115)
- 14 = New 1000 Series, Rating 1929/2300 (2125)
- 15 = New 1000 Series, Rating 1947/2300 (2135)
- 16 = New 1000 Series, Rating 1930/2200 (2150)
- 20 = Fastrac 2140 engine

* **D** = Transmission Speed Code:

- 3 = 30 km/h
- 4 = 40 km/h
- 5 = 55 km/h
- 6 = 65 km/h
- 7 = 75 km/h

C = 40 km/h (Fastrac 2140 only)

E = Vehicle Max. Speed Code:

- 30 = 30 km/h
- 40 = 40 km/h
- 50 = 50 km/h
- 80 = 80 km/h

F = Sequential Serial Number

Typical Engine Identification Number

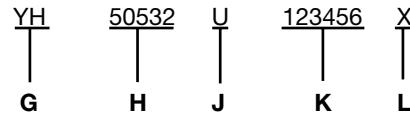

G = Engine Type:-

- YB = Turbocharged 1000 Series, 6 cylinder
- YD = Intercooled 1000 Series, 6 cylinder
- YH = Turbocharged New 1000 Series, 6 cylinder
- YK = Intercooled New 1000 Series, 6 cylinder

H = Build List Number

(see **Engine Technical Data** for details)

J = Country of Origin

K = Engine Serial Number

L = Year of Manufacture

* **Note:** Fastrac 2140 and 3185 engines are identified by the model number and a separate engine serial number.

Unit Identification

The serial number of each major unit is also stamped on the unit itself as shown below. If a major unit is replaced by a new one, the serial number on the plate will be wrong. Either stamp the new number of the unit on the identification plate, or simply stamp out the old number. This will prevent the wrong unit number being quoted when replacement parts are ordered.

- * Fastrac 2115, 2125, 2135, 2150 and 3155 Engines **M**
- Fastrac 2140 and 3185 Engines **T**
- Transmission (Assembly of all three gearboxes) **N**
- Speed Gearbox **P**
- Front Axle **R**
- Rear Axle **S**

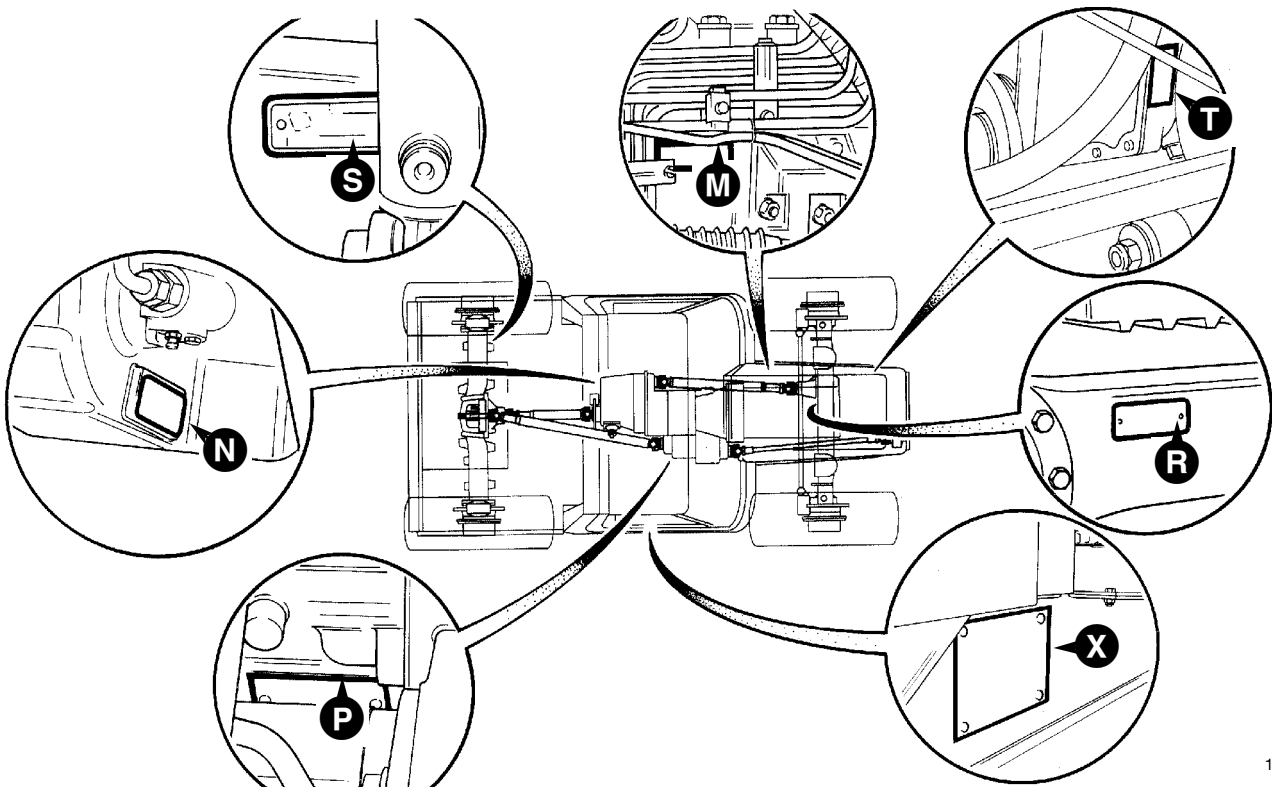

*** Introduction - Zinc Plated Fasteners and Dacromet Fasteners**

The JCB Fastrac 3000 series from serial number 642494 and the Fastrac 2000 series from serial number 740276 are assembled using an improved type of corrosion resistant finish on the external fasteners. This type of finish is called Dacromet and replaces the original Zinc and Yellow plating used on earlier machines.

The two types of fasteners can be readily identified by colour and part number suffix as follows:

Fastener Type	Colour	Part Number
Zinc and Yellow	Golden finish	'Z' (e.g. 1315/3712Z)
Dacromet	Mottled silver finish	'D' (e.g. 1315/3712D)

Note: As the Dacromet fasteners have a lower torque setting than the Zinc and Yellow fasteners, when servicing the Fastrac it is important that you are aware of this change of policy and that the information you are using is relevant to the type of fasteners that you have.

Note: A Dacromet bolt should not be used in conjunction with a Zinc and Yellow plated nut, as this could change the torque characteristics of the torque settings further. For the same reason, a Dacromet nut should not be used in conjunction with a Zinc and Yellow plated bolt.

Note: All bolts used on JCB machines are high tensile and must not be replaced by bolts of a lesser tensile specification.

Note: Dacromet bolts, due to their high corrosion resistance are used areas where rust could occur. Dacromet bolts are only used for external applications.

Zinc Plated Fasteners (golden finish)

Use only where no torque setting is specified in the text. Values are for dry threads and may be within three per cent of the figures stated. For lubricated threads the values should be REDUCED by one third.

Metric Grade 8.8 Bolts

Dia.	Bolt size		Torque Settings		
	(mm)	Hexagon (A/F) mm	Nm	kgf m	lbf ft
M5	(5)	8	7	0.7	5
M6	(6)	10	12	1.2	9
M8	(8)	13	28	3.0	21
M10	(10)	17	56	5.7	42
M12	(12)	19	98	10	72
M16	(16)	24	244	25	180
M18	(18)	27	350	36	258
M20	(20)	30	476	48	352
M24	(24)	36	822	84	607
M30	(30)	46	1633	166	1205
M36	(36)	55	2854	291	2105

Metric - All Internal Hexagon Headed Cap Screws

Diameter mm	Torque		
	Nm	kgf m	lbf ft
M3	2	0.2	1.5
M4	6	0.6	4.5
M5	11	1.1	8
M6	19	1.9	14
M8	46	4.7	34
M10	91	9.3	67
M12	159	16.2	117
M16	395	40	292
M18	550	56	406
M20	770	79	568
M24	1332	136	983

Metric Grade 10.9 Bolts

Dia.	Bolt size		Torque Settings		
	(mm)	Hexagon (A/F) mm	Nm	kgf m	lbf ft
M6	(6)	8	16	1.6	12
M8	(8)	13	39	4	29
M10	(10)	17	78	8	57
M12	(12)	19	137	14	101
M16	(16)	24	343	35	253
M20	(20)	30	657	67	485
M24	(24)	36	1157	118	853

Verbus Ripp Bolts

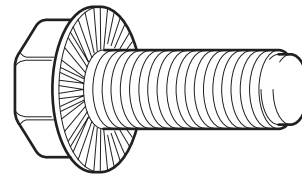

A343780

Torque settings for these bolts are determined by the application. Refer to the relevant procedure for the required settings.

Note: In most cases Verbus Ripp bolts should not be re-used. If one is disturbed it should be removed and a new one fitted in its place. For details of exceptions to this general rule, see T.I.'s 10/140 (F161/N. Am) and 10/141 (F162 N. Am).

Hydraulic Hose to Adapter Connections

BSP Size (inches)	Torque Settings		
	Nm	kgf m	lbf ft
1/8	14	1.4	10
1/4	24	2.5	18
3/8	33	3.3	24
1/2	44	4.8	35
5/8	58	6.0	43
3/4	84	8.6	62
1	115	11.8	85
1 1/2	244	24.9	180

Hydraulic Adapter into Component Connections with bonded washers

BSP Size (inches)	Torque Settings		
	Nm	kgf m	lbf ft
1/8	20	2.1	15
1/4	34	3.4	25
3/8	75	7.6	55
1/2	102	10.3	75
5/8	122	12.4	90
3/4	183	18.7	135
1	203	20.7	150
1 1/2	305	31	225

Dacromet Fasteners (mottled silver finish)

Use only where no torque setting is specified in the text.

NOTE: DACROMET FASTENERS ARE LUBRICATED AS PART OF THE PLATING PROCESS: DO NOT LUBRICATE.

Metric Grade 8.8 Bolts

Bolt size Dia.	Torque Settings		
	Nm	kgf m	lbf ft
M6 x 1.0	9	0.9	7
M8 x 1.25	22.5	2.3	17
M10 x 1.5	47.5	4.8	35
M12 x 1.75	80	8.2	59
M14 x 2	133	13.6	98
M16 x 2	200	20.4	148
M18 x 2.5	278	28.4	205
M20 x 2.5	392	40	289
M24 x 3	675	69	498
M30 x 3.5	1348	138	994

Metric Grade 10.9 Bolts

Bolt size Dia.	Torque Settings		
	Nm	kgf m	lbf ft
M6 x 1.0	13.5	1.4	10
M8 x 1.25	35	3.6	26
M10 x 1.5	62.5	6.4	46
M12 x 1.75	115	11.7	85
M14 x 2	175	17.9	129
M16 x 2	300	30.6	221
M18 x 2.5	395	40	291
M20 x 2.5	559	57	412
M24 x 3	962	98	710
M30 x 3.5	1920	196	1416

Metric Grade 12.9 Bolts

Bolt size Dia.	Torque Settings		
	Nm	kgf m	lbf ft
M6 x 1.0	15	1.5	11
M8 x 1.25	40	4.1	29
M10 x 1.5	80	8.2	59
M12 x 1.75	133	13.6	98
M14 x 2	225	23	166
M16 x 2	350	35.7	258
M18 x 2.5	463	47	342
M20 x 2.5	654	67	482
M24 x 3	1125	115	830
M30 x 3.5	2247	229	1657

Dacromet Fasteners (mottled silver finish) - List of Torque Settings

This list represents those fasteners which have been affected by the change from zinc-plated to Dacromet but are not mentioned in the service manual. The settings apply to 2000 and 3000 series machines unless otherwise stated.

Location: Rockinger Hitch Bolt
Nm: 392 **kgf m:** 40 **lbf ft:** 289

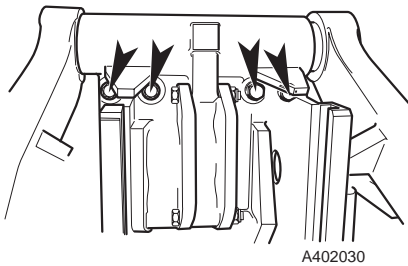

Location: Gearbox Crossmember
Nm: 200 **kgf m:** 20 **lbf ft:** 148

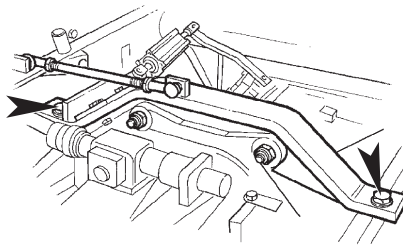

Bolt: Rear Crossmember
Nm: 392 **kgf m:** 40 **lbf ft:** 289

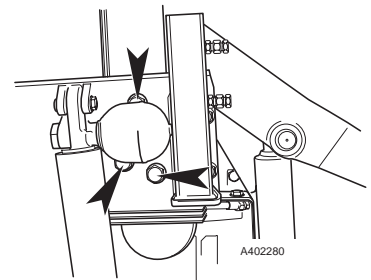

Bolt: Left Hand Pannier Step
Nm: 47.5 **kgf m:** 4.8 **lbf ft:** 35

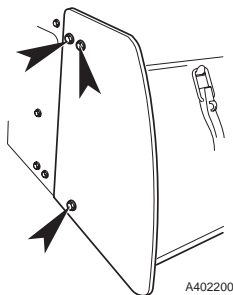

Bolt: Right Hand Pannier (rear)
Nm: 80 **kgf m:** 8.2 **lbf ft:** 59
 (2000 series machines only)

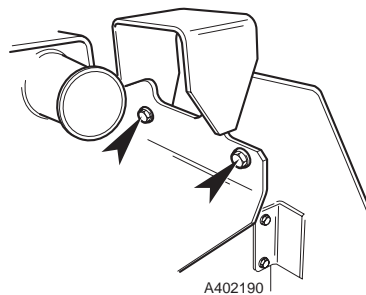

Bolt: Right Hand Pannier (front)
Nm: 47.5 **kgf m:** 4.8 **lbf ft:** 35
 (2000 series machines only)

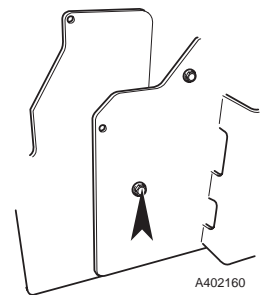

Bolt: Front Wrapper (top/bottom)
Nm: 392 **kgf m:** 40 **lbf ft:** 289

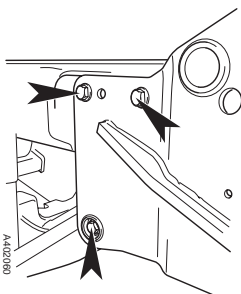

Bolt: Rear Lower Crossmember
Nm: 80 **kgf m:** 8.2 **lbf ft:** 59
 (2000 series machines only)

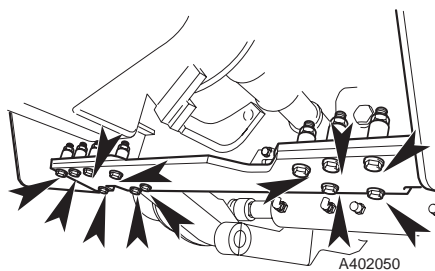

Bolt: Lower Link Bolt (Hex Head)
Nm: 392 **kgf m:** 40 **lbf ft:** 289

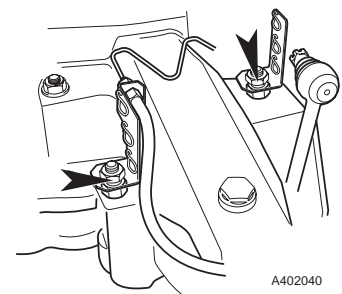

Dacromet Fasteners (mottled silver finish) - List of Torque Settings (cont.)

Location: Lower Link Bolt (capscrew)
Nm: 654 **kgf m:** 67 **lbf ft:** 482

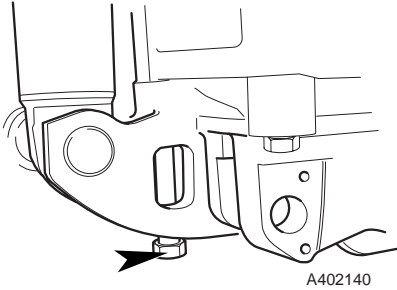

Location: Tower Casting to Axle
Nm: 392 **kgf m:** 40 **lbf ft:** 289

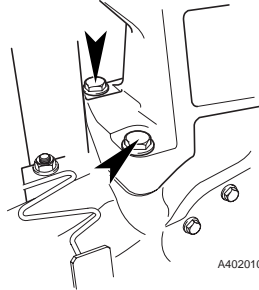

Location: Front Lower Crossmember
Nm: 115 **kgf m:** 12 **lbf ft:** 85

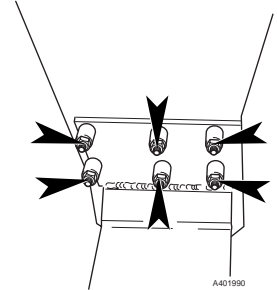

Location: Rear Lower Crossmember
Nm: 200 **kgf m:** 20 **lbf ft:** 148
 (3000 series machines only)

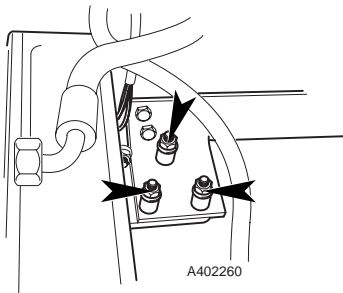

Location: Fuel Tank Support Strap
Nm: 47.5 **kgf m:** 4.8 **lbf ft:** 35
 (2000 series machines only)

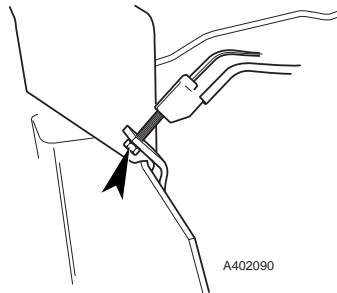

Location: Front P.T.O. Box
Nm: 200 **kgf m:** 20 **lbf ft:** 148

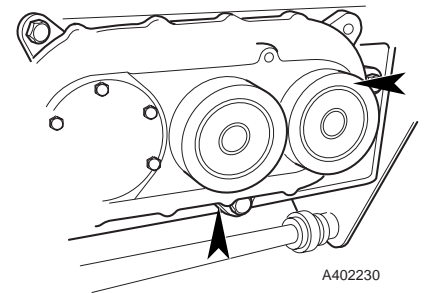

Location: Front Axle Upper Arm Mounting Bracket
Nm: 200 **kgf m:** 20 **lbf ft:** 148
 (3000 series machines only)

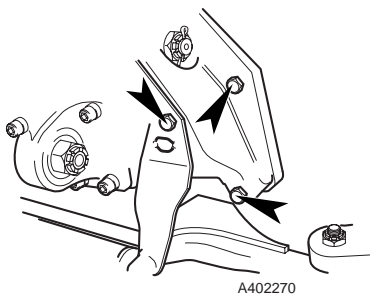

Location: Steershaft Bearing
Nm: 28 **kgf m:** 2.9 **lbf ft:** 21
 (3000 series machines only)

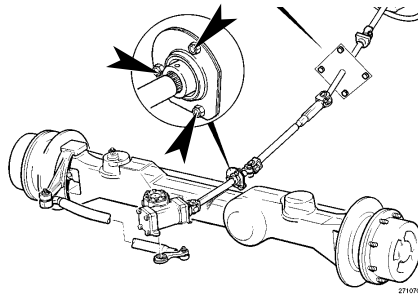

Location: Steershaft Intermediate UJ
Nm: 38 **kgf m:** 3.9 **lbf ft:** 28
 (3000 series machines only)

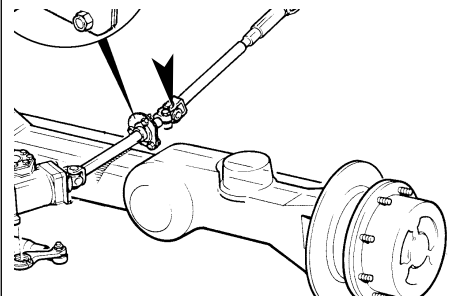

Dacromet Fasteners (mottled silver finish) - List of Torque Settings (cont.)

*** Location:** Front Anti-Roll Bar
Fasteners: Insulators
Nm: 47.5 **kgf m:** 4.8 **lbf ft:** 35

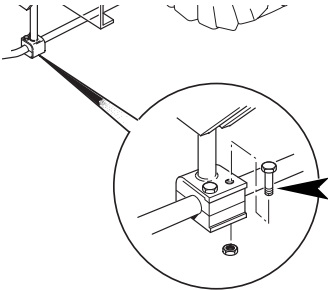

Location: Front Anti-Roll Bar
Fasteners: Pivot Bolt
Nm: 278 **kgf m:** 28 **lbf ft:** 205
(2000 series machines only)

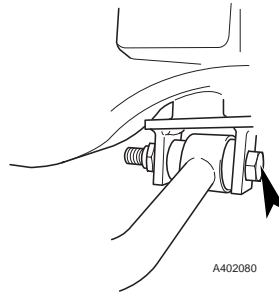

Location: 4.W.S. only rear anti-roll
bar crossmember
Nm: 80 **kgf m:** 8.2 **lbf ft:** 59
(2000 series machines only)

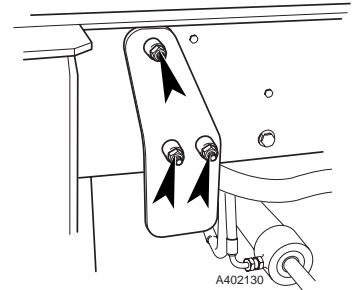

Location: Rear Anti-Roll bar
mounting bracket
Nm: 392 **kgf m:** 40 **lbf ft:** 289
(3000 series machines only)

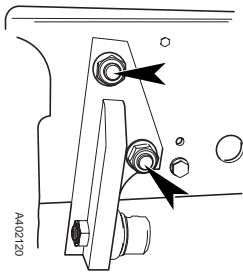

Location: Front Anti-Roll Bar
Fasteners: Pivot Bolt
Nm: 200 **kgf m:** 20 **lbf ft:** 148
(3000 series machines only)

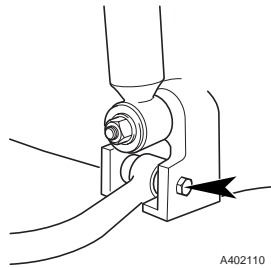

Location: Front Engine Mounting
Nm: 200 **kgf m:** 20 **lbf ft:** 148

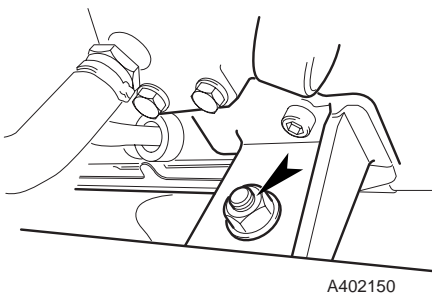

Location: Header Tank Clamp Plate
Nm: 30 **kgf m:** 3 **lbf ft:** 22
(3000 series machines only)

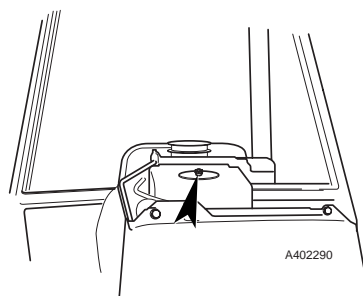

Sealing and Retaining Compounds

* Gasketing - Loctite 509	To seal the joint faces between the PTO/splitter gearbox, the speed gearbox and the range gearbox.	4102/3202 4102/3240	50ml 315 ml
JCB Multigasket	A medium strength sealant suitable for all sizes of gasket flanges, and for hydraulic fittings of 25-65 mm diameter.	4102/1212	
JCB High Strength Threadlocker	A high strength locking fluid for use with threaded components. Gasketing for all sizes of flange where the strength of the joint is important.	4102/0551	
JCB Retainer (High Strength)	For all retaining parts which are unlikely to be dismantled.	4101/0651	
JCB Threadlocker & Sealer	A medium strength locking fluid for sealing and retaining nuts, bolts, and screws up to 50 mm diameter, and for hydraulic fittings up to 25 mm diameter.	4101/0251	
JCB Threadlocker	For threads of suction strainer.	4101/0451	50ml
JCB Threadlocker & Sealer (High Strength)	A medium to high strength locking fluid.	4101/0552	
JCB Threadseal	Medium strength thread sealant (for patch bolts that are re-used).	4102/1951	50 ml
Clayton System Seal SC1251	A thread sealant used mainly on air brake system hose adapters.	4102/2210	2ml
JCB Activator	A cleaning primer which speeds the curing rate of anaerobic products.	4104/0251 4104/0253	Aerosol Bottle
JCB Cleaner/Degreaser	For degreasing components prior to use of anaerobic adhesives and sealants.	4104/1557	Aerosol
Direct Glazing Kit	For one pane of glass, comprises items marked † below plus applicator nozzle etc.	993/55700	
† Ultra Fast Adhesive	For direct glazing	4103/2109	310 ml
† Active Wipe 205	For direct glazing	4104/1203 4104/1206	250 g 30 ml
† Black Primer 206J	For direct glazing	4201/4906	30 ml
JCB Clear Silicone Sealant	To seal butt jointed glass. Also to seal hub planet gear carrier when no 'O' ring is fitted	4102/0901	
Black Polyurethane Sealant	To finish exposed edges of laminated glass	4102/2309	310 ml

Service Tools Numerical List

		Page No.			
1370/0901Z	Nut M24	9 - 1	892/00272	Adapter	7 - 1
1406/0021	Bonded Washer	7 - 1	892/00273	Sensor Head	7 - 1
1604/0006	Adapter	7 - 1	892/00274	Adapter	7 - 2
1604/0008	Adapter	7 - 1	892/00275	Adapter	7 - 1
1606/0012	Adapter	7 - 1	892/00276	Adapter	7 - 1
1606/0015	Adapter	7 - 1	892/00277	Adapter	7 - 1
1612/0006	Adapter	7 - 1	892/00278	Gauge 0 - 40 bar	7 - 2
* 331/64246	Tool Kit for Non-return Valve	7 - 2	892/00279	Gauge 0 - 400 bar	7 - 2
* 331/64265	Retaining Bush for Valve spool	7 - 2	892/00281	Avo Meter	6 - 1
4101/0251	JCB Threadlocker and Sealer	3 - 1	892/00282	Shunt	6 - 1
4101/0451	JCB Threadlocker	3 - 1	892/00283	Tool Kit Case	6 - 1
4101/0552	JCB Threadlocker and Sealer (High Strength)	3 - 1	892/00284	Digital Tachometer	6 - 1
4101/0651	JCB Retainer (High Strength)	3 - 1	892/00285	Oil Temperature Probe	6 - 1
4102/0551	JCB High Strength Threadlocker	3 - 1	892/00286	Surface Temperature Probe	6 - 1
4102/0901	JCB Clear Silicone Sealant	3 - 1	892/00293	Connector Pipe	7 - 1
4102/1212	JCB Multigasket	3 - 1	892/00294	Connector Pipe	7 - 1
4102/1951	JCB Threadseal	3 - 1	892/00298	Fluke Multimeter	6 - 1
4102/2210	Clayton System Seal SC1251	3 - 1	892/00311	Brake Test Kit	8 - 4
4102/2309	Black Polyurethane Sealant	3 - 1	892/00312	Dummy End Plate	8 - 2
4103/2109	Ultra Fast Adhesive	3 - 1	892/00313	Clutch Alignment Tool	8 - 1
4104/0251	JCB Activator (Aerosol)	3 - 1	892/00314	Accumulator Adapter	9 - 1
4104/0253	JCB Activator (Bottle)	3 - 1	892/00315	Engine Support Brackets	8 - 1
4104/1557	JCB Cleaner/Degreaser	3 - 1	892/00318	Hose and Adapter Kit	7 - 2
4104/1203	Active Wipe 205 (250 g)	3 - 1	892/00333	Heavy Duty Socket, 19 mm A/F	8 - 2
4104/1206	Active Wipe 205 (30 ml)	3 - 1	892/00334	Gland Seal Fitting Tool	7 - 2
4104/1310	Hand Cleaner	5 - 1	892/00706	Test Probe	7 - 2
4201/4906	Black Primer	3 - 1	892/00800	Splitting Frame	8 - 1
454/30056	Spacer 13.80 mm	8 - 4	892/00801	Clutch spanner	5 - 3
477/00437	Gearbox Lifting Adapter	8 - 2	892/00802	Rotor puller set	5 - 3
721/00664	Connecting Lead (Psion Workabout)	6 - 1	892/00803	Rotor installer set	5 - 3
721/10885	Harness - Diagnostic (J1939)	6 - 2	892/00807	Front plate puller	5 - 3
816/15118	Test Adapter	7 - 1	892/00808	Shaft protector	5 - 3
816/20008	Adapter	7 - 1	892/00812	Drive Coupling Spanner	8 - 1
816/20013	Adapter	7 - 1	892/00817	Heavy Duty Socket, 17 mm A/F	8 - 2
816/55038	Adapter/Test Point	7 - 1	892/00818	Heavy Duty Socket, 22mm A/F	8 - 2
816/55040	Adapter/Test Point	7 - 1	892/00819	Heavy Duty Socket, 15 mm A/F	8 - 2
892/00041	Deglazing Tool	9 - 2	892/00842	Glass Lifter	5 - 1
892/00078	Connector	7 - 1	892/00843	Folding Stand	5 - 1
892/00137	Micro Bore Hose	7 - 2	892/00844	Long Knife	5 - 2
892/00174	Measuring Cup	8 - 2	892/00845	Cartridge Gun	5 - 1
892/00179	Bearing Press	8 - 1	892/00846	Glass Extractor Handles	5 - 2
892/00180	Seal Fitting Tool	9 - 1	892/00847	Nylon Spatula	5 - 3
892/00181	Replacement Plastic Boss	9 - 1	892/00848	Wire Starter	5 - 2
892/00223	Hand Pump	7 - 2	892/00849	Braided Cutting Wire	5 - 2
892/00224	Impulse Extractor	8 - 2	892/00864	PD 90 Axle Locknut Spanner	8 - 4
892/00225	Adapter for Impulse Extractor	8 - 1	892/00871	Frame (Puller Adapter Assembly)	9 - 1
892/00253	Pressure Test Kit	7 - 1	892/00874	Brace (Puller Adapter Assembly)	9 - 1
892/00255	Adapter/Test Point	7 - 1	892/00875	Bar M24 (Puller Adapter Assembly)	9 - 1
892/00256	Adapter/Test Point	7 - 1	892/00876	Block (Puller Adapter Assembly)	9 - 1
892/00257	Adapter/Test Point	7 - 1	892/00882	Socket	6 - 1
892/00258	Adapter/Test Point	7 - 1	892/00883	Spanner (Steer Box Input Shaft Nuts)	9 - 1
892/00259	Adapter/Test Point	7 - 1	892/00884	'C' Spanner (Steer Box Input Shaft Nuts)	9 - 1
892/00260	Adapter/Test Point	7 - 1	892/00892	Speed Gearbox Locking Tool	8 - 3
892/00261	Adapter/Test Point	7 - 1	892/00916	Spring Compressor	8 - 3
892/00262	Adapter/Test Point	7 - 1 & 7 - 2	892/00918	Setting Tool Kit	8 - 4
892/00263	Adapter/Test Point	7 - 1	892/00945	Sleeve for M30 Pinion	8 - 4
892/00264	Adapter/Test Point	7 - 1	892/00956	Timing Pin for Fuel Injection Pump	9 - 2
892/00265	Adapter/Test Point	7 - 1	892/01033	Data Link Adapter Kit	6 - 2
892/00268	Flow Monitoring Unit	7 - 1	892/01045	Peg Socket - Wet Clutch	8 - 5
892/00269	Sensor Head	7 - 1	892/01046	Mandrel - Wet Clutch	8 - 5
892/00270	Load Valve	7 - 1	892/01047	Jig - Wet Clutch	8 - 5
892/00271	Adapter	7 - 1			

Service Tools Numerical List (continued)

		Page No.
892/01048	Clutch Pack Retainer - Wet Clutch (2 required)	8 - 4
892/01049	Guide Rod - Wet Clutch (2 required)	8 - 4
892/01050	Mandrel - Wet Clutch	8 - 5
892/01051	Intermediate Gear Retaining Tool - Wet Clutch Transmission	8 - 4
892/01052	Locking Plate - Wet Clutch (2 required)	8 - 4
892/01053	Adapter for impulse extractor (PTO intermediate shaft, wet clutch transmission)	8 - 2
* 892/01092	Wheel Hub Service Kit	8 - 5
926/15500	Rubber Spacer Blocks	5 - 3
992/12300	Mobile Oven	5 - 1
992/12400	Static Oven	5 - 1
992/12600	Static Oven	5 - 1
992/12800	Cut-out Knife	5 - 2
992/12801	'L' Blades	5 - 2
993/45400	Torque Multiplier	8 - 2
993/55700	Direct Glazing Kit	3 - 1
993/59300	Pressure Test Adapter and Clamp	8 - 3
993/70111	Break-back Torque Wrench	8 - 4
993/85700	Battery Tester	6 - 1
997/11000	Drive Head Setting Bracket	8 - 4
997/11100	Adapter for M24 Pinion	8 - 4

The following parts are replacement items for kits and would normally be included in the relevant kit numbers.

Replacement items for kit no. 892/00253

892/00201	Gauge 0 - 20 bar	7 - 1
892/00202	Gauge 0 - 40 bar	7 - 1
892/00203	Gauge 0 - 400 bar	7 - 1
892/00254	Hose	7 - 1
* 993/69800	Seal Kit	7 - 1

*** Replacement parts for kit no. 892/01092**

1315/3414Z	Bolt M10x60	8 - 5
1315/3731Z	Bolt M16x220	8 - 5
1315/3835Z	Bolt M20x300	8 - 5
1370/0301Z	Nut M10	8 - 5
1370/0401Z	Nut M12	8 - 5
1370/0601Z	Nut M16	8 - 5
1370/0701Z	Nut M20	8 - 5
1420/0009Z	Washer M12	8 - 5
1420/0012Z	Washer M20	8 - 5
445/12303	Washer	8 - 5
892/00891	Dolly	8 - 5
917/02800	Bearing	8 - 5
998/10606	Bearing Fitting Tube	8 - 5
998/10607	Inner Bearing Plate	8 - 5
998/10608	Bearing Centre Puller	8 - 5
998/10610	Puller Rod	8 - 5
998/10614	Reaction Tube	8 - 5
998/10615	Wheel Bearing Carrier Puller	8 - 5
998/10616	Puller Handle Nut	8 - 5
998/10623	Puller Beam	8 - 5
998/10624	Modified Wheel Stud	8 - 5

Service Tools

Section B - Body and Framework

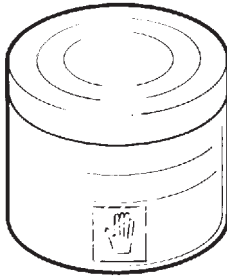

S186240

Hand Cleaner - special blend for the removal of polyurethane adhesives.

JCB part number - 4104/1310 (454g; 1lb tub)

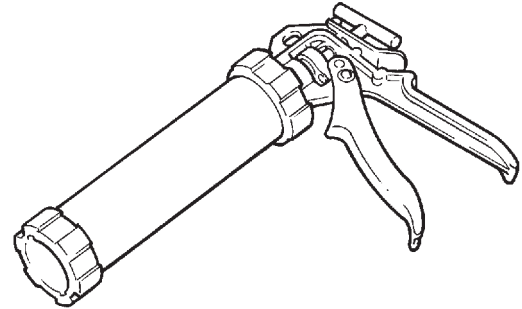

S186270

Cartridge Gun - hand operated - essential for the application of sealants, polyurethane materials etc.

JCB part number - 892/00845

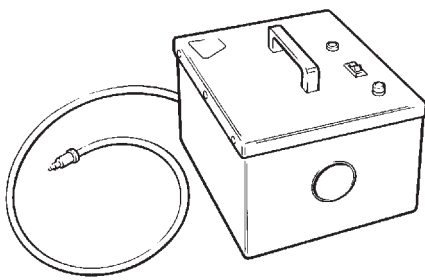

S186250

12V Mobile Oven - 1 cartridge capacity - required to pre-heat adhesive prior to use. It is fitted with a male plug (703/23201) which fits into a female socket (715/04300).

JCB part number - 992/12300

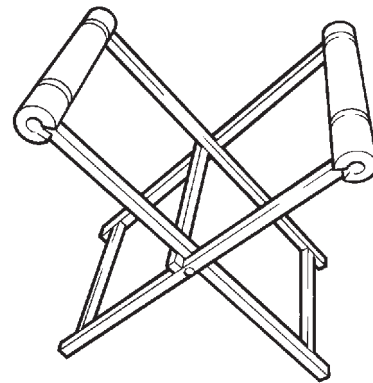

S186280

Folding Stand for Holding Glass - essential for preparing new glass prior to installation.

JCB part number - 892/00843

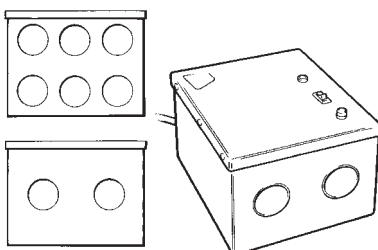

S186260

240V Static Oven - available with 2 or 6 cartridge capacity - required to pre-heat adhesive prior to use. No plug supplied. Note: 110V models available upon request - contact JCB Technical Service

JCB part number:
992/12400 - 2 cartridge x 240V
992/12600 - 6 cartridge x 240V

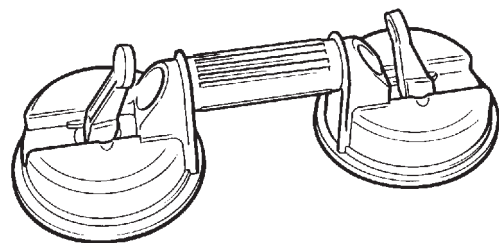

S186300

Glass Lifter - minimum 2 off - essential for glass installation, 2 required to handle large panes of glass. Ensure suction cups are protected from damage during storage.

JCB part number - 892/00842

Service Tools (continued)

Section B - Body and Framework (continued)

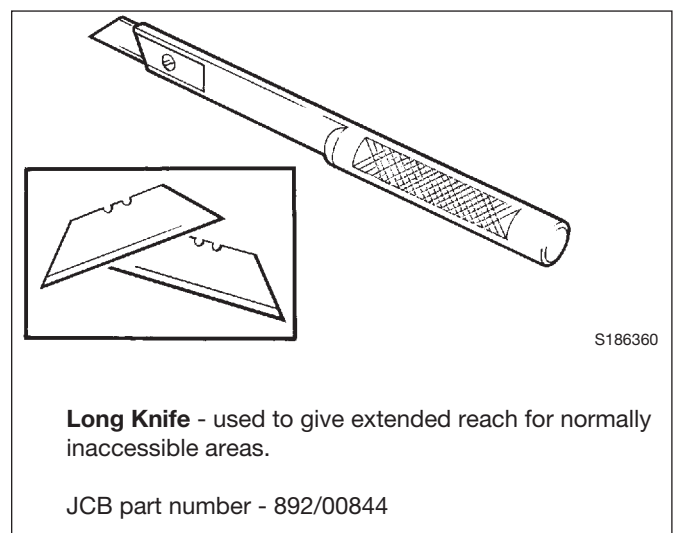
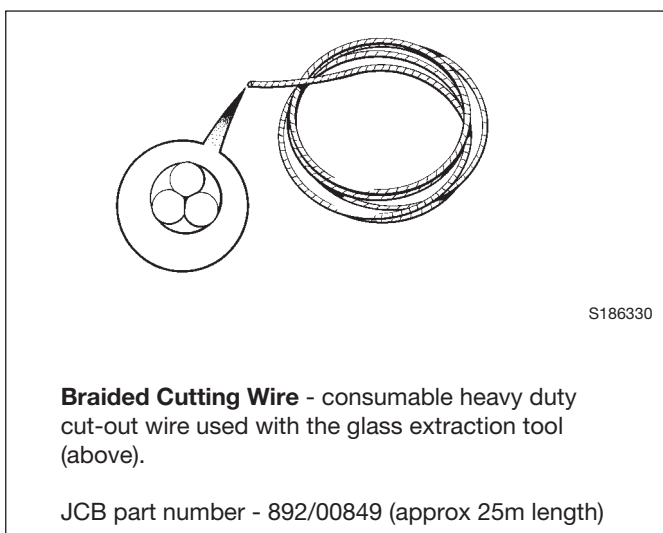
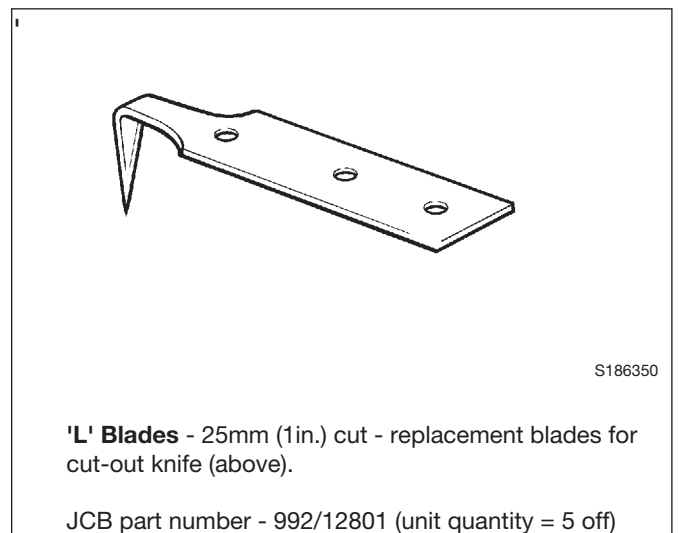
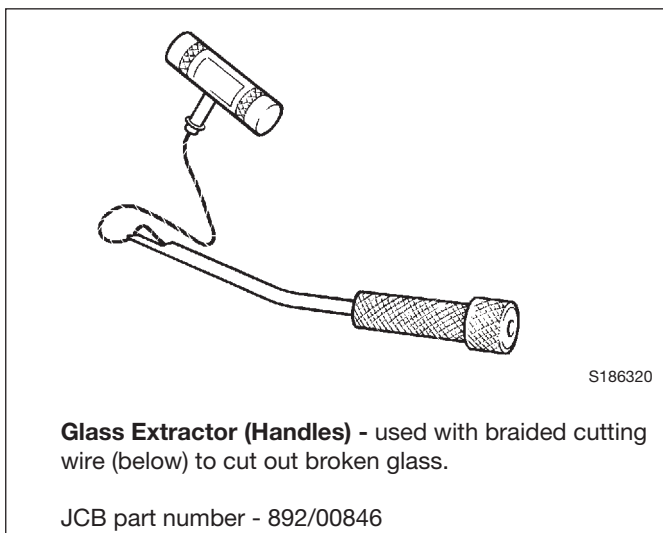
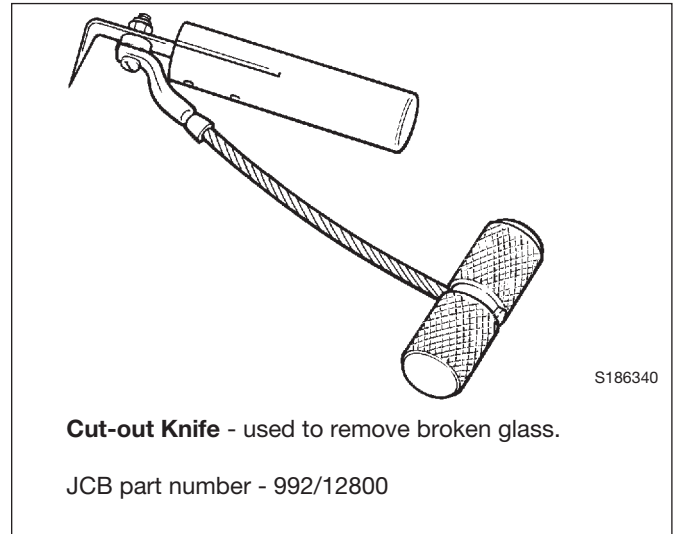
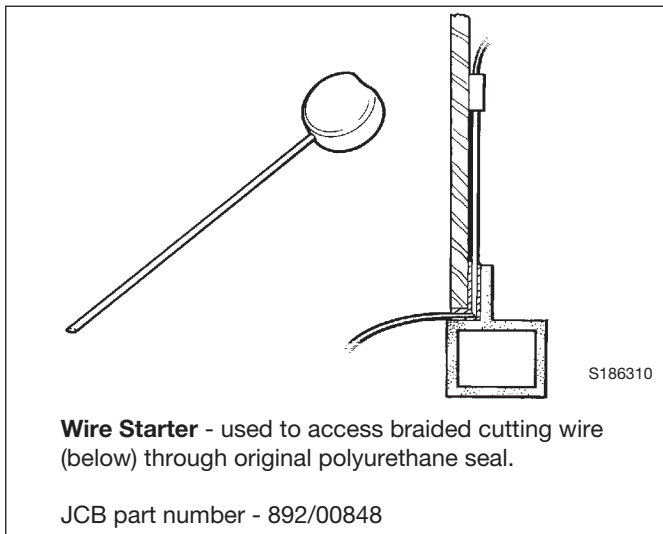

Service Tools (continued)

Section B - Body and Framework (continued)

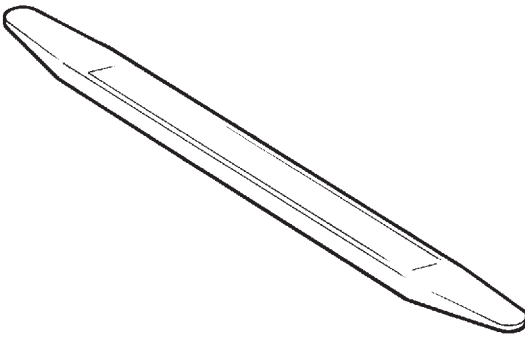

S186470

Nylon Spatula - general tool used for smoothing sealants - also used to re-install glass in rubber glazing because metal tools will chip the glass edge.

JCB part number - 892/00847

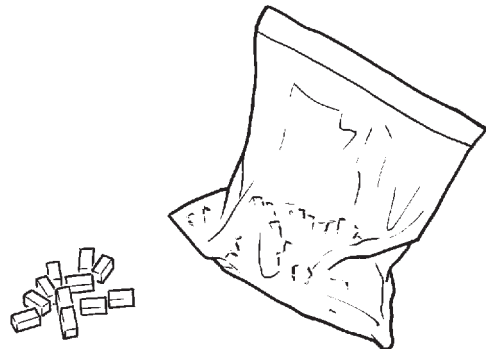

S186550

Rubber Spacer Blocks - used to provide the correct set clearance between glass edge and cab frame.

JCB part number - 926/15500
(unit quantity = 500 off)

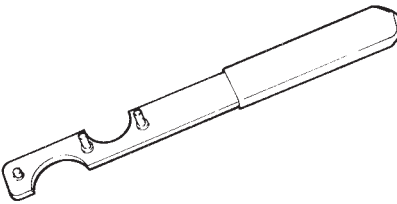

892/00801 Clutch spanner for air conditioning compressor S200940

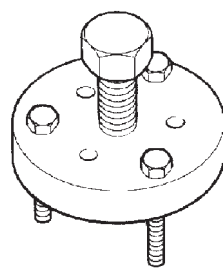

892/00807 Front plate puller for air conditioning compressor S200970

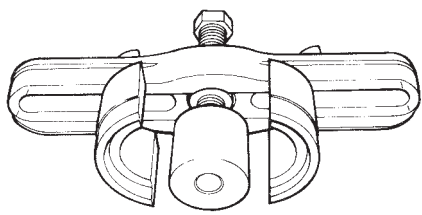

892/00802 Rotor puller set for air conditioning compressor S200950



892/00808 Shaft protector for air conditioning compressor S200980

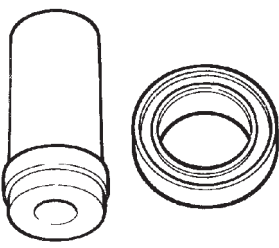

892/00803 Rotor installer set for air conditioning compressor S200960

Service Tools

Section C - Electrics

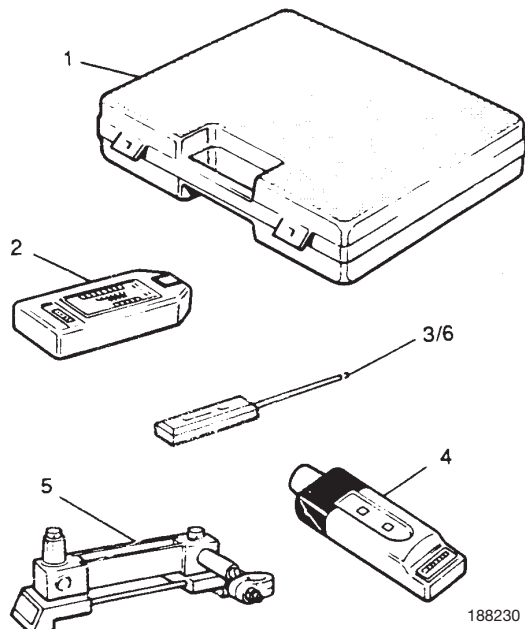

Electrical Test Equipment

- 1 892/00283 Tool Kit Case
- 2 892/00281 AVO Meter
- 3 892/00286 Surface Temperature Probe
- 4 892/00284 Microtach Digital Tachometer
- 5 892/00282 100 Amp Shunt - open type
- 6 892/00285 Hydraulic Oil Temperature Probe
- 7 892/00298 Fluke 85 Multimeter

188230

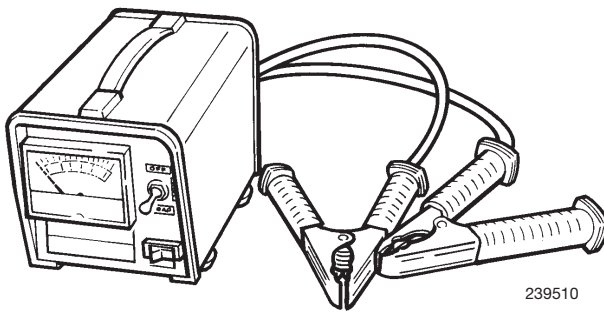

239510

993/85700 Battery Tester

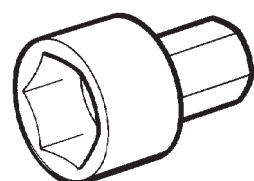

S216770

892/00882 Socket for Pulley Nut on Magneti Marelli Alternator.

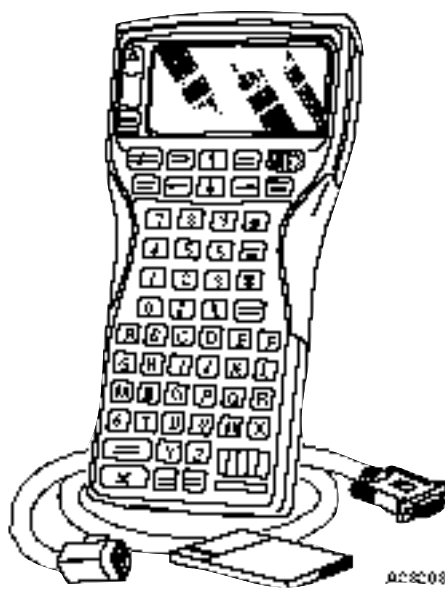

0020080

Psion Workabout 1Mb/RS232 †
 Docking Holster †
 Software - Psion Link, Version 1.1 †
 721/00664 Connecting Lead
 2 x CD ROM ††

† These items to be obtained from your nearest Psion agent as listed on M.I.'s 569/H, 525 HA and 516E.
 †† As detailed on the same M.I.'s as above.

BUY NOW

**Then Instant Download
the Complete Manual
Thank you very much!**